



Make it grain.

Table of Contents

This manual covers Mojave firmware v1.0.1

Foreword	1
Description	2
Module Installation	2
Technical Specifications	3
Recommended Listening	4
Recommended Reading	4
Front Panel Diagram	5
Functions	
• LED UI	6
• Mix	6
• Clock/Tap Tempo	6
• Gen	7
• Rate	7
• Distribute	8
• Structure	8
• Drift	9
• Whirl	9
• Gust	10
• Size	10
• Zone	11
• Speed	11
• Window	12
• Lock	12
• Freeze	12
• Gen Mode	13
• Clock Mode	13
• Sky Mode	14
• Dune Output	15
• Microphone	15
• USB Drive/Narwhal Settings	16
• Audio IO	17
• Secondary Menu	17
Calibration	18
Patch Examples	19
Lifetime Warranty	23
Changelog	24

Special thanks to Jeremy Leaird-Koch ([Red Means Recording](#)) for being an excellent beta tester. Mojave would not be the module it is without him!

Foreword

When I think back to the founding of Qu-Bit, it's impossible not to think about granular synthesis. After all, the very first product we made was a granular sampler. This should come as no surprise since our mission statement was to implement novel DSP algorithms in hardware synthesizers. And what's cooler than granular synthesis?

Since then I've always wanted the opportunity to create a granular instrument that was focused on live processing, instead of recorded buffers. Something with a hands-on interface that could provide plug and play, instant results to any incoming audio signal. Inspiration struck during a trip to Joshua Tree where I experienced a dust storm. Wind gusts were driving sand into the windows of our Airbnb at varying speeds and densities, creating a symphony of granular cacophony. I knew right then that we had to create a desert-inspired granular processor.

Fast forward 2 years, and here it is, Mojave! The name comes from a massive desert located in Southern California, which also contains Joshua Tree national park. All in all, I'm extremely proud of how this design turned out. The macro controls in tandem with the different Sky Modes were unexpected features that turned this module into something really special, and different than I had originally envisioned. I hope the sonic landscapes that Mojave provides capture your imagination and inspire your patching process.

Fair winds and happy trails!

Happy Patching,
Andrew Ikenberry
Founder & CEO



Bouldering on Dragon Scales in Joshua Tree, CA.

Description

Mojave is a musically minded granular sandstorm. Drawing its inspiration from vast swaths of desert in the American Southwest, Mojave is a live granular processor that uses microscopic bits of audio to create beautifully crafted sonic landscapes.

The core of Mojave's sound design palette is a unique set of melodic and rhythmic controls that presents each grain in a musical context. Generate clock-synced granular arpeggios, or envelope your sound in rich harmonic swirls with the turn of a knob. All microsound settings can be easily accessed via individual knobs letting you tailor each grain, and effortlessly construct dunes of sound. Mojave is not exclusive to modular signals either; become the wind itself by using the onboard microphone to sift through and manipulate acoustic audio.

And, just like Nautilus, Mojave's internal settings can be configured via the USB drive and the Narwhal web app. Whether you are constructing pebbles or sandstone monuments, Mojave is the perfect balance between exploratory sound design and harmonious sublimity.

- Live granular processor and stochastic event generator
- Onboard high quality MEMS microphone
- Configurable Dune CV/Gate output
- Firmware updates & alternate firmware via the USB Drive
- Based on the Daisy platform

Module Installation

To install, locate 14HP of space in your Eurorack case and confirm the positive 12 volts and negative 12 volts sides of the power distribution lines.

Plug the connector into your case's power supply unit, keeping in mind that the red band corresponds to negative 12 volts. In most systems, the negative 12 volt supply line is at the bottom.

The power cable should be connected to the module with the red band facing the bottom of the module.

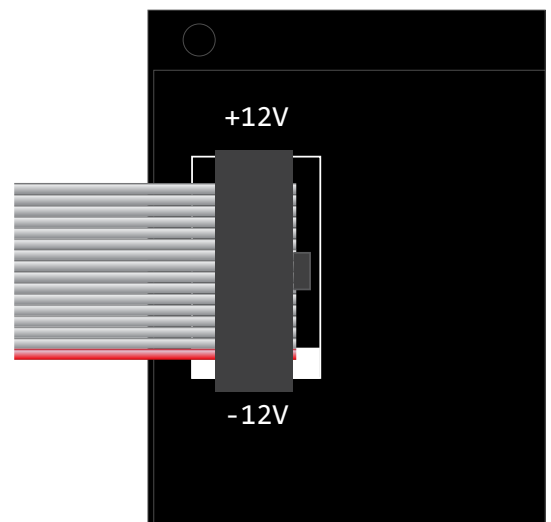

Technical Specifications

General

- Width: 14HP
- Depth: 22mm
- Power Consumption: +12V=167mA, -12V=13mA, +5V=0mA

Audio

- Sample Rate: 48kHz
- Bit-depth: 32 bit (internal processing), 24-bit (hardware conversion)
- True Stereo Audio IO
- High fidelity Burr-Brown converters
- [Based on Daisy audio platform](#)

Controls

- Knobs
 - Resolution: 16-Bit (65,536 distinct values)
- CV Inputs
 - Resolution: 16-Bit (65,536 distinct values)

USB Port

- Type: A
- External Power Draw: up to 500mA (for powering external devices via USB). Please note that additional power drawn from the USB must be considered within your PSU's total current consumption.

Signal Path

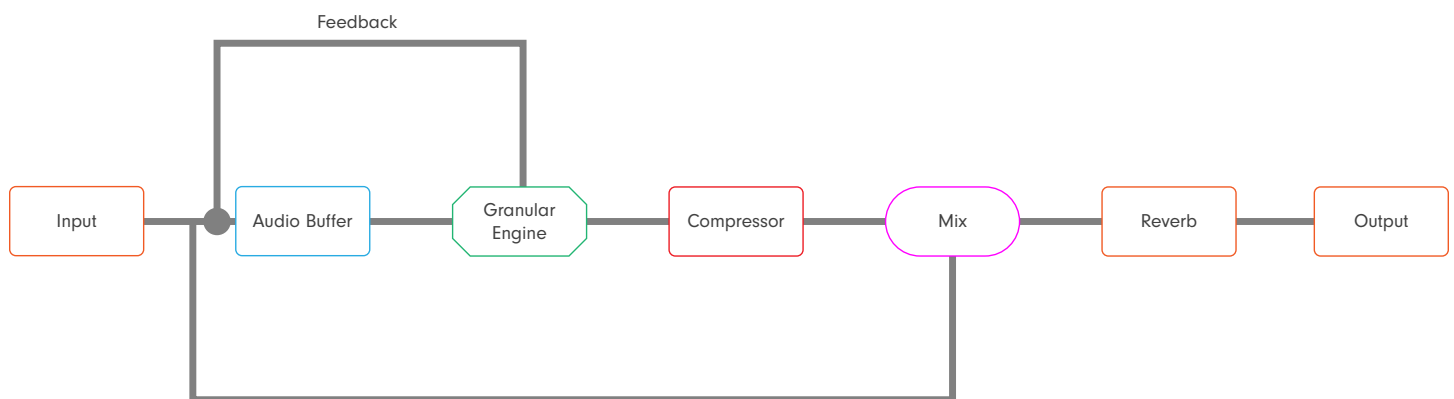

Recommended Listening

Curtis Roads (1999-2003) - Point Line Cloud

Bio Excerpt: Curtis Roads creates, teaches, and pursues research in the interdisciplinary territory spanning music and sound technology. His pedagogical pedigree includes Harvard University, Université Paris, MIT, and more, and he also co-founded the International Computer Music Association.

A pioneer in the development of granular synthesis (1974), Roads has been at the forefront of experimental audio analysis and sound design. Among his published books are a multitude of computer music based texts, including the prolific *Microsound*, which dives into compositional techniques using sound particles.

Barry Truax (1986) - *Riverrun*

Professor Emeritus of Simon Fraser University, Barry Truax is a Canadian composer credited with the first ever implementation of real-time granular synthesis, which can be heard in his 1986 composition, *Riverrun*. Additional Listening: *Wings of Nike* (1987)

Recommended Reading

Microsound - Curtis Roads

[MIT Press](#)

Formalized Music: Thought and mathematics in composition - Iannis Xenakis

[PDF](#)

The Computer Music Tutorial - Curtis Roads

[MIT Press](#)

Front Panel

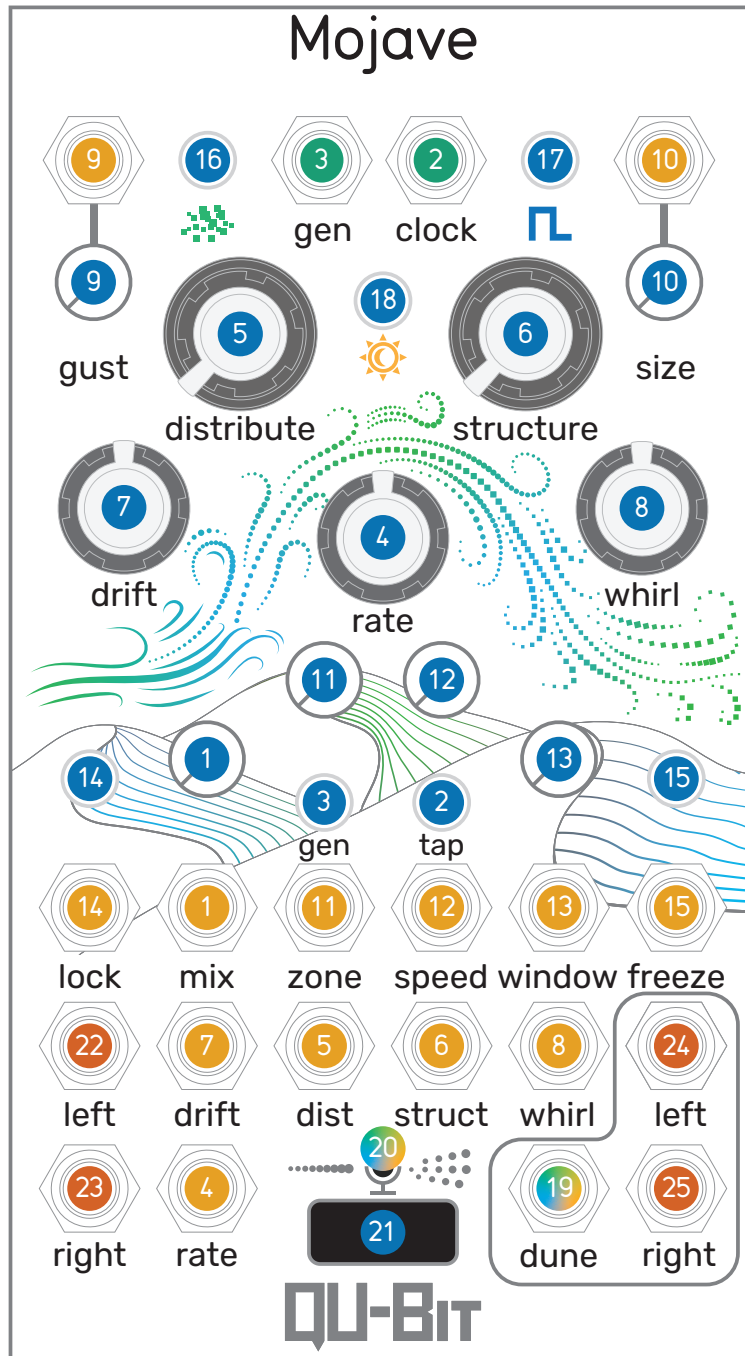

Functions - Primary Controls

LED UI

The LED user interface is the primary visual feedback between you and Mojave. It mediates a host of settings in real time to keep you in your patch!

The desert wind displays visual feedback for grain amount, size, playback speed, and zone position, while also indicating the Sky Mode.

The dune LEDs indicate Lock and Freeze states, Rate position, Zone and Speed positions, and more!



1. Mix

- The **Mix Knob blends between the dry and wet signal**. When the knob is **fully counter-clockwise**, only the dry signal is present. When the knob is **fully clockwise**, only the wet signal is present.

Mix Curve: The default mix curve is a constant power pan curve, which fades between the dry and wet signal while avoiding a dip in volume at the midpoint. Select alternate mix curve options via [the Narwhal web app!](#)

- **Mix CV Input Range:** -5V to +5V

2. Clock Input / Tap Tempo Button

- The **Clock Input** syncs Mojave with an external clock. This will determine Mojave's buffer size, and also sync a host of controls on the front panel to quantized patterns.

Clock Input/Clock Mode Relation: In **Free Clock Mode**, The Clock Input and Tap Tempo will set the audio buffer size, which is 2 bars of the clock rate. The Clock Input will also act as a clock reset, and sets the front panel controls' quantizations.

In **Quantized Clock Mode**, Mojave uses the clock rate set by either the Tap Tempo Button or the Clock Input to determine the audio buffer size, as well as the divisions and multiples for Mojave's Rate knob, and the quantizations of Mojave's control ranges.

Learn more about clock modes in the [Clock Mode Button section!](#)

Absolute minimum and maximum clock rate range: 15BPM (4s) to 60,000BPM (1ms)

- **Clock Gate Input Threshold:** 0.4V

Functions - Primary Controls

3. Gen

- The **Gen Button and Gen Gate Input** trigger a grain independent of the clock rate, and determined by the rest of the knobs on Mojave.

Once a grain is triggered, Mojave will read its grain settings, then play the grain in its entirety until complete. Send multiple rapid gates to overlap events, and create interesting, syncopated granular rhythms!

- **Gen Gate Input** Threshold: 0.4V

Did You Know? There are 3 different Gen Modes! Learn how to use audio levels to generate grains and more by [heading to the Gen Mode Table](#).

4. Rate

- The **Rate Knob** controls the frequency at which the grains are triggered. This can range from exceptionally slow (fully **counter-clockwise**) to audio rate speeds (fully **clockwise**), and can either be a smooth, freerunning rate, or a quantized division or multiple of a clock rate!

Rate/Clock Mode Relation: In the default **Free Clock Mode**, Rate smoothly transitions between slow grain triggers on the left of the knob, all the way up to audio rate triggers on the right.

For a quantized rate control with divisions/multiplications, change the **Clock Mode** (17) from Free (Blue LED) to **Quantized Clock Mode** (Gold LED). This allows Rate to act as a div/mult control for the internal or external clock.

See the graphic below for a list of available rate divisions/multiples in the Quantized Clock Mode:

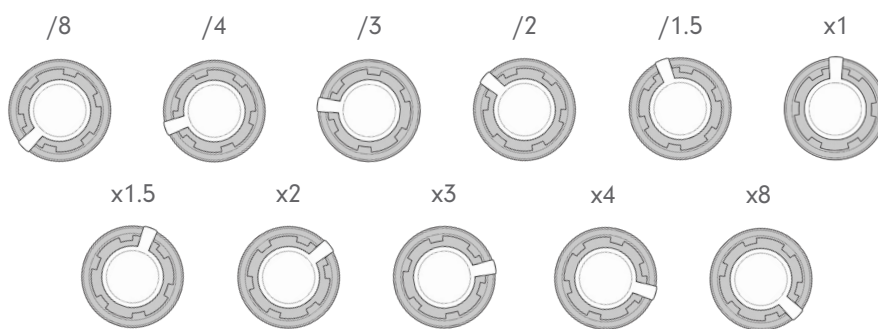

Rate LED Indication: Rate changes in the quantized mode are indicated by white LED blip in the center Dune LED.

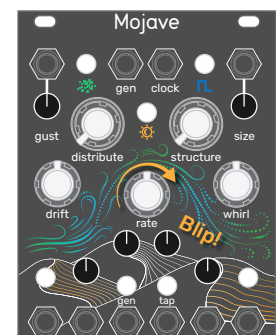
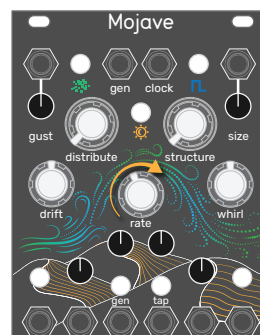

- **Rate CV Input** Range: -5V to +5V

Functions - Primary Controls

5. Distribute

● The **Distribute Knob** is a rhythm event generator. Turning up Distribute increases the chance and intensity of **rhythmic variations** within a single grain.

Distribute - Free Clock Mode:

When the distribute knob is **fully counter-clockwise**, no rhythmic variation is added and the grains play straight through.

As the Distribute knob is turned **clockwise**, there is a percentage increase that a grain will begin to deviate from the expected grain rate. As the knob reaches the end, grains are 100% randomly triggered outside the grain rate, resulting in beautiful, textural chaos.

Distribute - Quantized Clock Mode:

When Distribute is used in this clock mode, it instead increases the chance of quantized, rhythmic variations in the grain rate. You can expect rests, ratchets, and pulsating patterns to come out of this knob, all while staying clock-synced with the rest of your patch.

● **Distribute CV Input Range:** -5V to +5V

6. Structure

● The **Structure Knob randomly manipulates grain pitch**. Unlike Distribute, which increases in amount of modulation over the knob, Structure adds and removes certain types of pitch modulation across the knob, which are highlighted below:

Knob Position: 0%

No random pitch modulation

Knob Position: 1%-33%

Semitone pitch shifts on each grain. Perfect for creating high rate, granular swarms, or turning a saw wave into a massive super-saw.

Knob Position: 33%-45%

Octaves are introduced alongside the semitone pitches.

Knob Position: 45%-55%

Octave pitch shifts only.

Knob Position: 55%-65%

All notes in the melodic range are available, determined by the selected Sky Mode.

Knob Position: 65%-100%

Melodic events, such as arpeggios and trills, are introduced, increasing in frequency across the range.

Did You Know? Both the Distribute knob and the Structure knob are tied to Mojave's Sky Mode! [Head to the Sky Mode section](#) to learn more.

● **Structure CV Input Range:** -5V to +5V

Functions - Primary Controls

7. Drift

- Much like the previous 2 knobs, Mojave's **Drift Knob** picks **random positions within the audio buffer where it generates its grains**. It's important to note that Drift will affect the grain's position *in relation to the Zone knob position*.

When the knob is fully **counter-clockwise**, Drift does not affect the grain position. When the knob is fully **clockwise**, Drift randomly pulls audio from all parts of the audio buffer to fill Mojave's grains.

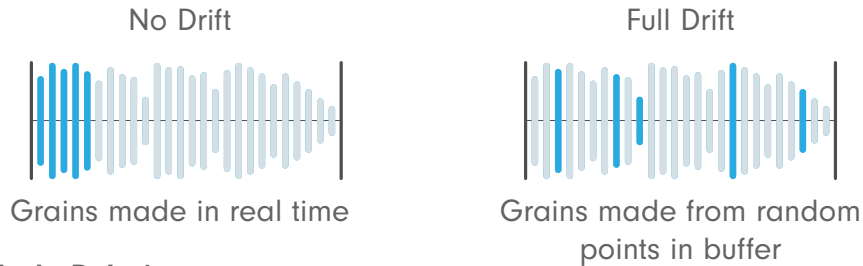

Drift/Clock Mode Relation:

In **Free Clock Mode**, Drift generates grains randomly across the whole buffer, increasing its max distance from the Zone knob position as the knob is turned clockwise.

In **Quantized Clock Mode**, Drift randomly jumps through the audio buffer at quantized positions, ie quarter notes, whole notes, eighth notes, etc.

- **Drift CV Input** Range: -5V to +5V

Drift LEDs: The grain position controlled by both Drift and Zone (11) is displayed on the Wind LEDs via a **White** LED.

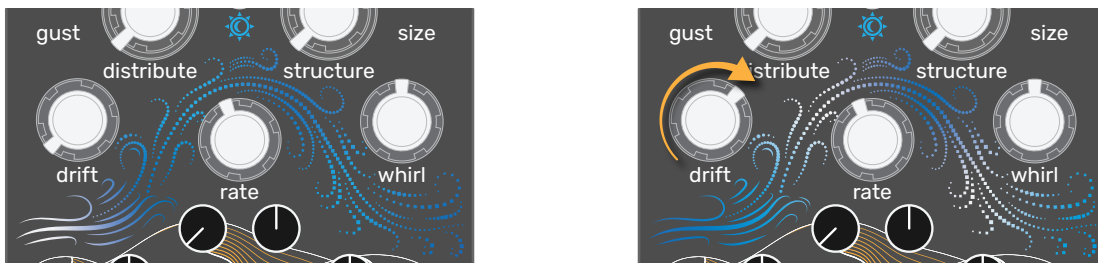

8. Whirl

- The **Whirl Knob** controls the amount of **random stereo panning** applied to each grain. When the knob is **fully counter-clockwise**, the stereo position of the grains matches the incoming audio.

Turning the knob **clockwise**, grains deviate from their original stereo position, all the way to fully random positioning. This is a great way to add stereo width to a stereo or monophonic sound!

- **Mix CV Input** Range: -5V to +5V from the knob position.

Whirl/Narwhal Relation: Swap or include the ability for Whirl to introduce randomly reversed grains via [the Narwhal web app!](#)

Functions - Primary Controls

9. Gust

- The **Gust Knob** is an end of chain effect, and can either be **internal feedback**, or a **lush reverb**. There is no effect when the knob is at the center position, and is visually indicated by a pulsing Gen Mode LED.

Turning the Gust knob to the **left of center** will increase the **feedback amount**.
Turning the Gust knob to the **right of center** will increase the **reverb amount**.

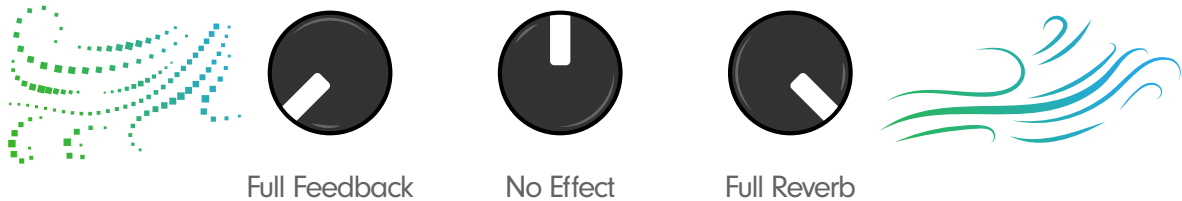

- **Gust CV Input Range:** -5V to +5V

Experiment: To hear the full potential of Mojave’s Feedback effect, we recommend checking out our [Feedback Fundamentals patch example at the end of this manual!](#)

Reverb/Narwhal Relation: Set the reverb decay, dampening, and width using our [Narwhal web app!](#)

10. Size

- The **Size Knob** adjusts both the **length** and **playback direction** of each grain. The length range is 20ms to 4s, with the shortest grain length found at the center position on the knob.

Turning the Size knob to the **right from center** will play back the grains **forward**.
Turning the knob **left from center** will play back the grains in **reverse**.

It’s also important to note that any reverse grains will also flip the Window shape, to emphasize the “reverse-ness” of the audio!

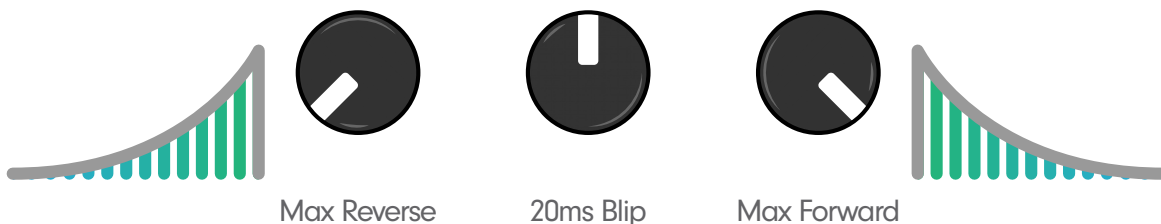

- **Size CV Input Range:** -5V to +5V

Size/Rate Relation: The maximum grain size is directly tied to the Rate knob position. Maximum size will always be 10x the length of the current grain rate.

Did You Know? You can have Whirl control random amounts of reversed grains? [Head to the Narwhal web app to learn more!](#)

Functions - Primary Controls

11. Zone

- Turning the **Zone Knob** will determine the **audio buffer position** where grains are generated.

When the knob is **fully counter-clockwise**, Mojave uses **real-time audio to generate grains**.

As the knob **turns clockwise**, the audio buffer position begins to **sift through older parts of the audio buffer**, which is up to the full audio buffer length from the present!

Zone LEDs: As Zone moves about the buffer, the Wind LEDs will indicate its general position within the buffer.



Zone/Drift Relation: The Zone knob not only moves the spot where grains are generated, but it acts as the offset position for Drift's random grain position modulation!

Zone/Lock Relation: When Lock is activated, the Zone knob becomes a buffer scrub. Learn more about this control relationship in [the Lock section!](#)

- **Zone CV Input Range:** -5V to +5V

12. Speed

- The **Speed Knob** adjusts the **vari-speed pitch of each generated grain**. The full range of pitch shifting is **-2 octaves to +2 octaves**, with the **original pitch at the center** on the knob. The Speed CV input **tracks 1V/Oct**.

Speed LEDs: The center Dune graphic illuminates when Speed is on an octave. The center Dune is not illuminated when Speed is on a different pitch interval between octaves.

Speed/Structure Relation: The Speed knob acts as an offset position for Structure to base its random pitch modulation on. Check out our [Instant Polyphony patch example](#) to see how to harness this relationship for your music!

Speed/Sky Mode Relation: Just like Structure, Speed is quantized to whichever Sky Mode scale is selected. See the [Sky Mode section](#) to learn more.

- **Speed CV Input Range:** -5V to +5V. Tracks 1V/Oct.

Functions - Primary Controls

13. Window

- The **Window Knob** controls the **envelope shape of each grain**, and crossfades between 5 main shapes. See the window shapes below, which are listed left to right across the knob:

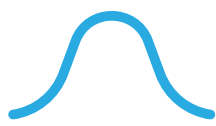

Hamming



Up Ramp



Triangle



Exp. Down Ramp



Square

Window LEDs: Each window corresponds with a unique LED color displayed across Mojave's dunes.

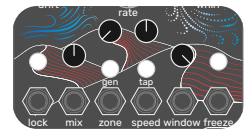
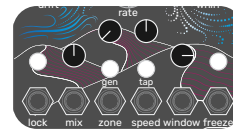
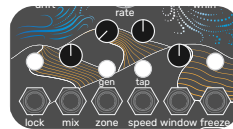
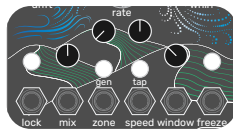
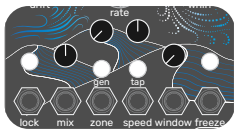

- **Window CV Input Range:** -5V to +5V

14. Lock

- The **Lock Button** and gate input will lock the current audio buffer in place, while allowing Mojave to change and generate grains with the frozen buffer.

Lock LED: The Left Dune LED will turn **White** when Lock is active.

Lock/Zone Relation: When the audio buffer is locked, Zone acts as a buffer scrub on the audio. With Rate up and Size set just enough to overlap grains, Mojave's locked buffer can perform pseudo time-stretching effects.

- **Lock Gate Input Threshold:** +0.4V

15. Freeze

- The **Freeze Button** will **freeze the grains** in place. While frozen, all grain related controls are halted, and unable to affect the frozen grains. Perfect for awesome granular stutters!

Freeze LED: The Right Dune LED will turn **White** when Freeze is active.

Freeze/Buffer Relation: When Freeze is active, the audio buffer will refill with new incoming audio every audio buffer length. The default length is 2 bars of the clock rate. You can change the audio buffer length via the [Narwhal web app!](#)

- **Freeze Gate Input Threshold:** +0.4V

Functions - Primary Controls

16. Gen Mode



- The **Gen Mode Button** cycles between **three grain generation modes**. Each mode changes how Mojave reads signals to create new grains, both gate and audio signals!

Erode (Default)

LED Color: **Blue**

In Erode, Mojave generates grains each clock pulse, as well as from the Gen button and gate input.

Shear

LED Color: **Green**

In Shear, Mojave monitors the incoming audio stream, and grains are generated when audio hits a determined threshold.

Chisel

LED Color: **Gold**

In Chisel, Mojave only generates grains from the Gen button and gate input. All other generation sources are ignored.

17. Clock Mode



- The **Clock Mode Button** swaps between **2 clock modes, Free and Quantized**. These modes determine whether or not the grain generations and manipulations are synced to a pre-determined clock rate, either with an external clock, or a tap-tempo'ed internal clock.

Free (Default)

LED Color: **Blue**

In **Free Clock Mode**, Mojave's **Rate knob** controls the clock rate along a smooth range, from 15BPM to audio rate.

Additionally, certain controls like Drift and Distribute behave in an asynchronous manner, as opposed to adhering to a quantized time grid.

Quantized

LED Color: **Gold**

In **Quantized Clock Mode**, Mojave reads either an internal clock or an external clock, and quantizes its controls and grain generation accordingly.

The default quantized internal clock runs at 120BPM. Adjust the clock by using the [Tap Button](#) to tap tempo a new clock rate, or by patching an external clock signal to the [Clock Gate Input](#).

Read each control section to learn more about their relationships with the Clock modes!

Functions - Primary Controls



18. Sky Mode

- The **Sky Mode Button** changes Mojave's quantization mode between 4 configurable options. These quantizations affect the **Structure** and **Zone** knobs, as well as the rhythmic components across Mojave.

Default Sky Modes

Dawn

LED Color: **Blue**

Quantization: Major Scale

Dusk

LED Color: **Gold**

Quantization: Chromatic Scale

Day

LED Color: **Green**

Quantization: Minor Scale

Twilight

LED Color: **Purple**

Quantization: Unquantized both in pitch and rhythm

Sky Mode LEDs: Each Sky Mode not only changes the button color, but also the Wind LED colors.

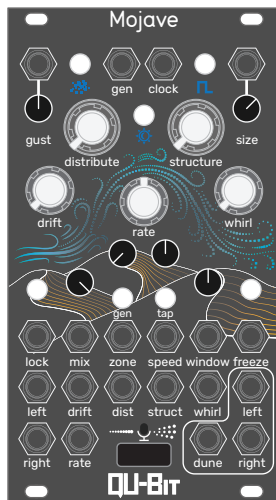

Dawn

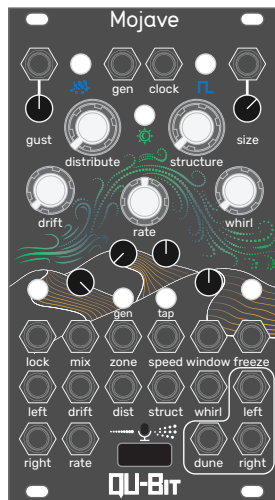

Day

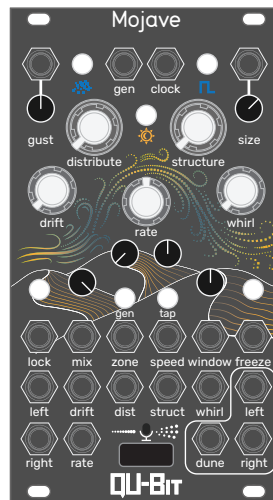

Dusk



Twilight

Did You Know? Each Sky Mode quantization can be configured independently using the Narwhal web app! Available quantizations include:

- Major
- Minor
- Major Pentatonic
- Minor Pentatonic
- Chromatic
- Harmonic Minor
- Whole Tone
- Unquantized

Head to the USB section for more information!

Functions - Primary Controls

19. Dune

- The **Dune Output** is a unique **CV/Gate generator** that analyzes the environmental conditions within Mojave, and outputs an algorithmically determined signal.

- **CV Output (Default)**

Mojave generates a variable modulation source, with macro controls providing unique conditions for the signal to respond to. See the conditions below to fine tune the output signal:

Distribute: Controls the amount of stepped modulation. When Distribute is fully counter-clockwise, the modulation is smooth. Increasing Distribute morphs Dune into stepped modulation, and then increases the step length.

Drift: Controls the modulation direction. The default direction is an ascending ramp wave. Increasing Drift amount increases the probability of switching to a descending ramp wave. Bringing Drift fully counter-clockwise while Dune is in a descending ramp state will lock the ramp direction.

Whirl: Controls the speed of the modulation. The Dune output is at its slowest when Whirl is fully counter-clockwise, and at it's fastest when fully clockwise.

Learn how to change the Dune output state, and what signals are available in the [USB section](#) of the manual!

20. Microphone



- Become the wind itself with the onboard **Microphone!** The microphone allows Mojave to process and granularize acoustic audio.

The microphone is normalled to the left input channel, and shares an input level control with the audio inputs. See the settings below to learn how to control the microphone state:

Clock Mode+Mix: Adjusts the input level for the audio inputs and microphone.

Clock Mode+Lock: Changes the microphone state.

Blue (Default): Microphone is normalled to the left input. When no patch cable is present at the left input, the microphone is active.

Green: Microphone is off.

Gold: The inputs and the microphone are summed together, both active at all times.

Controlling Mic Feedback: To mitigate potential feedback issues with speakers, avoid running only the dry signal on Mojave while the microphone is active, and also avoid wet signals with the same pitch as the dry signal. These conditions increase the risk of unwanted feedback.

Functions - Primary Controls

21. USB/Narwhal



- The **Mojave USB Port** and included **USB Drive** are used for firmware updates, alternate firmwares, and additional configurable settings. The USB drive does not need to be inserted in Mojave for the module to operate. Any USB-A drive will work, as long as it is formatted to FAT32.

Narwhal

Effortlessly change Mojave USB settings using **Narwhal**, a web-based settings app that lets you change a multitude of functions and interconnectivity within Mojave. Once you have your desired settings, click the “generate file” button to export an options.json file from the web app.

Place the new options.json file onto your USB drive, insert it into Mojave, and your module will instantly update its internal settings! You’ll know the update is successful when the Dune LEDs flash **White**.

Narwhal Settings

These are the current settings available in Narwhal. More configurable settings will be added in future updates.

Setting	Default	Description
Buffer Size	8 Beats (2 Bars)	Determines the size of the live audio buffer.
Fixed Buffer Time	6 seconds	Sets the length for the “Fixed Buffer Time” buffer size option.
Whirl Behavior	Stereo Spatialization	Controls the Whirl macro control behavior. Swap in or include random reverse grain playback.
Mix Curve	Constant Power	Sets the curve applied to the cross-fade signal on Mix.
Reverb Size	0.7	Sets the reverb size on the Gust control
Reverb Dampening	0.1	Applies the amount of dampening on the reverb signal.
Dune Behavior	Morphing Voltage	Reconfigures the Dune output signal. Choose either Morphing CV, Grain Gates, or a Clock Passthrough
Reset Clock in Free Mode	True (ON)	The Tap button and Clock input will resync the clock rate, and act as if the internal clock was triggered.
Dotted Notes in Ext. Clock	True (ON)	Includes dotted quarter notes on the Rate control in Quantized Clock Mode.
Dawn Scale Quantization	Major	Override the default scale with one of your choosing.
Day Scale Quantization	Minor	Override the default scale with one of your choosing.
Dusk Scale Quantization	Chromatic	Override the default scale with one of your choosing.

[Discover Narwhal](#)

Functions - Primary Controls

22. Audio Input Left

- Audio input for Mojave's left channel. The left input normals to both channels when no cable is present in Audio Input Right.
Input Range: 10Vpp AC-Coupled (input level configurable via Clock Mode+Mix function)

23. Audio Input Right

- Audio input for Mojave's right channel.
Input Range: 10Vpp AC-Coupled (input level configurable via Clock Mode+Mix function)

24. Audio Output Left

- Audio output for Mojave's left channel.
Input Range: 10Vpp

25. Audio Output Right

- Audio output for Mojave's right channel.
Input Range: 10Vpp

Functions - Secondary Controls

Clock Mode+Mix: Input Level

- Holding the **Clock Mode Button** and turning the **Mix Knob** will **set the audio input level**, adjusting both the audio input jacks and the microphone level. This allows for Mojave to accept line level signals at the maximum.

Clock Mode+Gust: LED Brightness

- Holding the **Clock Mode Button** and turning the **Gust knob** will **adjust the LED brightness**, from max brightness at fully clockwise, and minimum brightness at fully counter-clockwise.

Clock Mode+Freeze: Reset Input Level

- Holding the **Clock Mode Button** and pressing the **Freeze Button** quickly **resets the input level** to the default (modular level).

Clock Mode+Lock: Microphone State

- Holding the **Clock Mode Button** and pressing the **Lock Button** changes the **microphone state**. See the [Microphone section](#) for available settings.

Clock Mode+Sky Mode: Firmware Update

- Holding the **Clock Mode button** and pressing the **Sky Mode button** will cause Mojave to **search for a new firmware file on the USB Drive, and update**. This allows users to update their module with alternate firmware or new Mojave firmware without power cycling their system!

Functions - Calibration

Speed V/Oct Calibration

Mojave is calibrated in our factory using precise laboratory grade equipment and we do not recommend recalibrating unless you have found a tracking mismatch between it and another module. However, should you need to recalibrate your module for whatever reason, the steps are listed below:

1. **Hold down Tap**, and **boot up Mojave**. Hold the button down until the Dune LED pulses **gold**.
2. With no other CV/Gate inputs present in the module, patch in 1V (1 octave up from root on your sequencer) to the Speed CV input.
3. Press Sky Mode. The Left Dune LED will now illuminate green.
4. Patch 3V (3 octaves up from root on your sequencer) into the Speed CV input.
5. Press Sky Mode. Your module is now calibrated to 1V/oct and is in normal operating mode. For different voltage standards (such as Buchla's 1.2V) adjust the CV inputs accordingly. To discard your recalibration and revert to the original calibration settings, press the Clock Mode button to exit the mode.

Knob/CV Re-calibration

Holding the Gen button and **booting up Mojave** will recalibrate the knobs and CV inputs.

This might be necessary when external electrical conditions, like improper grounding, affect the analog nature of the controls. This may result in the Mix knob not going fully dry or fully wet, the Window shape zones or Speed octave positions being off from what they used to be, etc.

Performing the button prompt will cause Mojave to analyze and recalibrate all its controls, keeping them nice and tight!

Patch Example: Basic Granular Texturizer

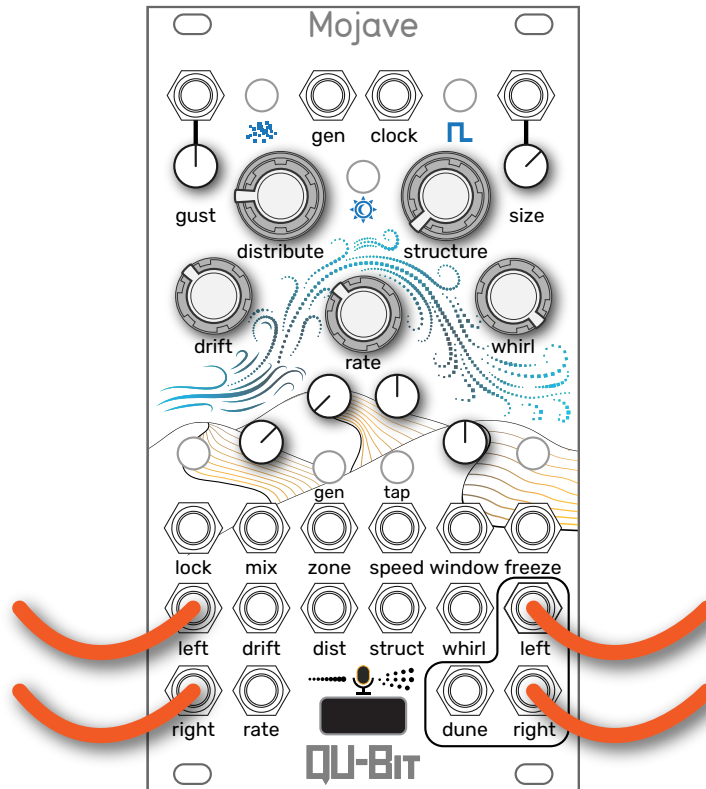

Settings

Clock Mode: Free (default)

Gen Mode: Erode (default)

Sky Mode: Dawn (default)

Let's get started with Mojave by getting a basic granular effect going, with some subtle variation! Our Free Clock is set to a fast, yet discernible rate, allowing our triangle shaped grains to be both rapid and distinguished above the dry signal.

Our three macro knobs in use are Distribute, Drift, and Whirl. Read below to see what each control is doing to our granular texture:

Distribute: adding random chance for a grain to be *slightly off*, rhythmically, from the grain rate.

Drift: pushing the grains back a random amount in the audio buffer to create a small delay in the dry and wet audio.

Whirl: adding the maximum amount of random stereo panning to the grains. Because stereo is good.

To hear this patch in action, head over to our video patch example!

[Example Video](#)

Patch Example: Instant Polyphony

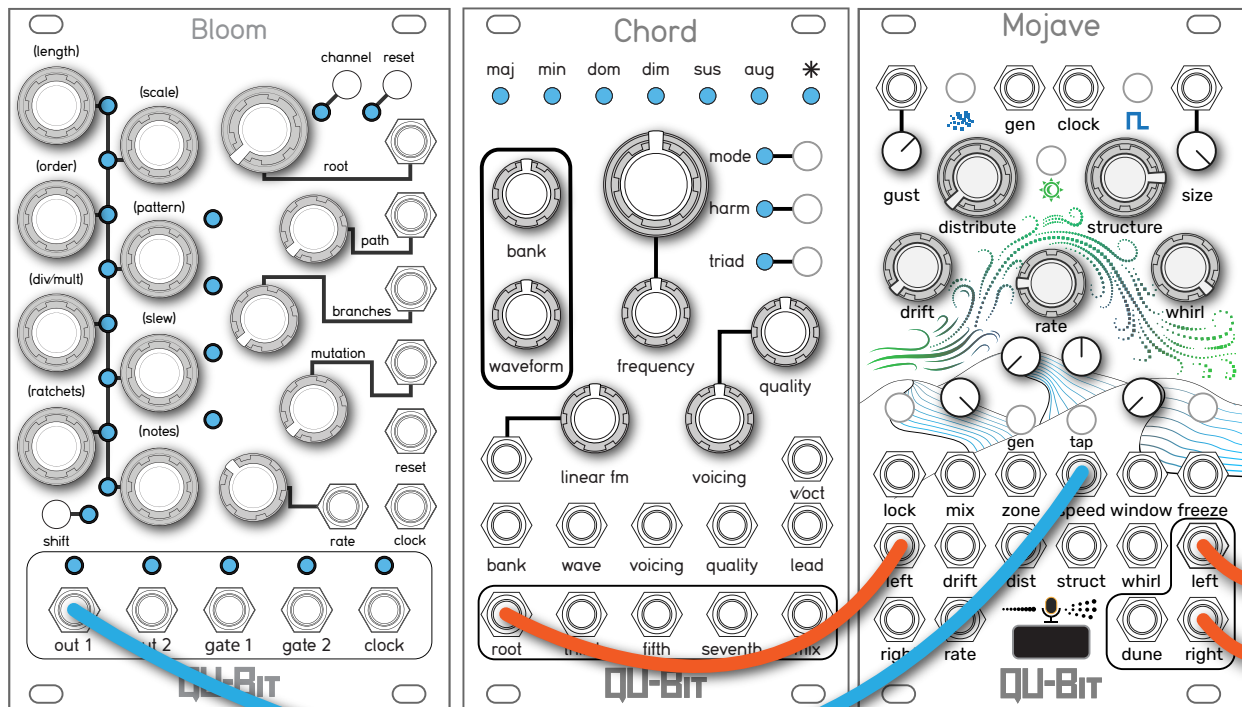

Settings

Clock Mode: Free (default)

Gen Mode: Erode (default)

Sky Mode: Day

Window: Hamming

Take any monophonic sound source and turn it into a stereo, polyphonic symphony with Structure! With a slow Rate, and Structure up, Mojave will take a single droning sound source, like an oscillator, and transform it into a harmonic swirl.

Each generated grain will be pitched to a new note within the Sky Mode quantized scale, and with Size at the maximum, the notes will overlap one another to build evolving pads. We are using the minor scale in the Day Mode here, but you can use any quantized scale available in the default Sky Modes, or the available scales in Narwhal!

Another fun addition to this patch is sending CV into Speed, which is also quantized to the Sky Mode scale. Since the transposition is diatonic, Speed pitch changes will cause "chord" changes in Structure, always keeping you in key.

[Example Video](#)

Patch Example: Granular Looper

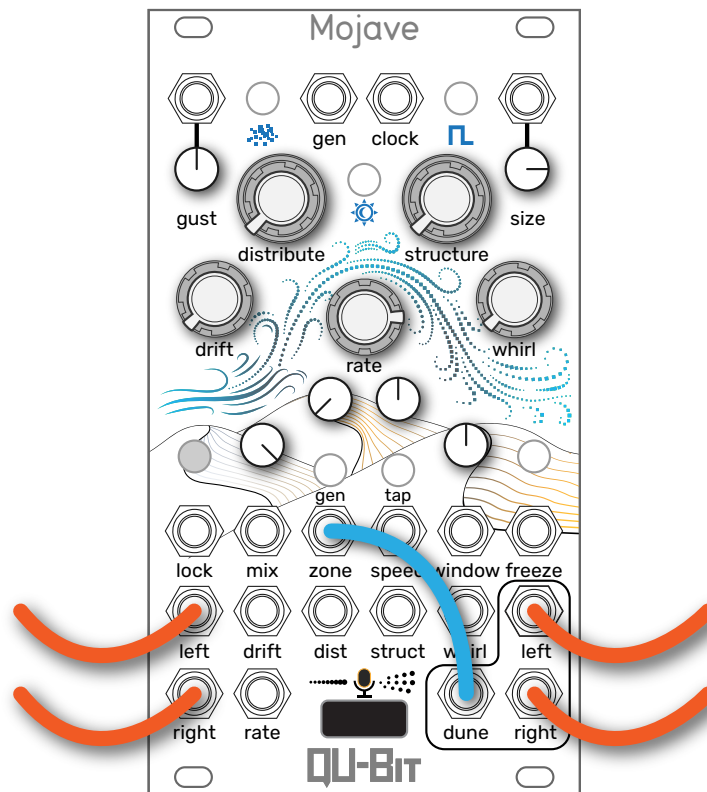

Settings

Window: Triangle

Lock: Activated

Dune Output: CV (default)

Turn your Mojave into a mini-Nebulae! This patch example takes advantage of the Lock control, which locks the audio buffer in place, and the Zone control, which scrubs the audio buffer.

With Rate high, and Size up enough to overlap grains, Mojave can mimic time-stretching effects.

To loop the frozen buffer, patch Mojave's default Dune output to the Zone CV input. You'll notice that the audio buffer may be playing back in reverse. This is because the up ramp CV from Dune is moving Zone from the most recent audio in the buffer, to the oldest audio.

Turn up Drift to randomly change the CV direction, and once it is flipped bring Drift back down to lock the direction. Or, patch an external envelope generator for additional control!

[Example Video](#)

Patch Example: Feedback Fundamentals

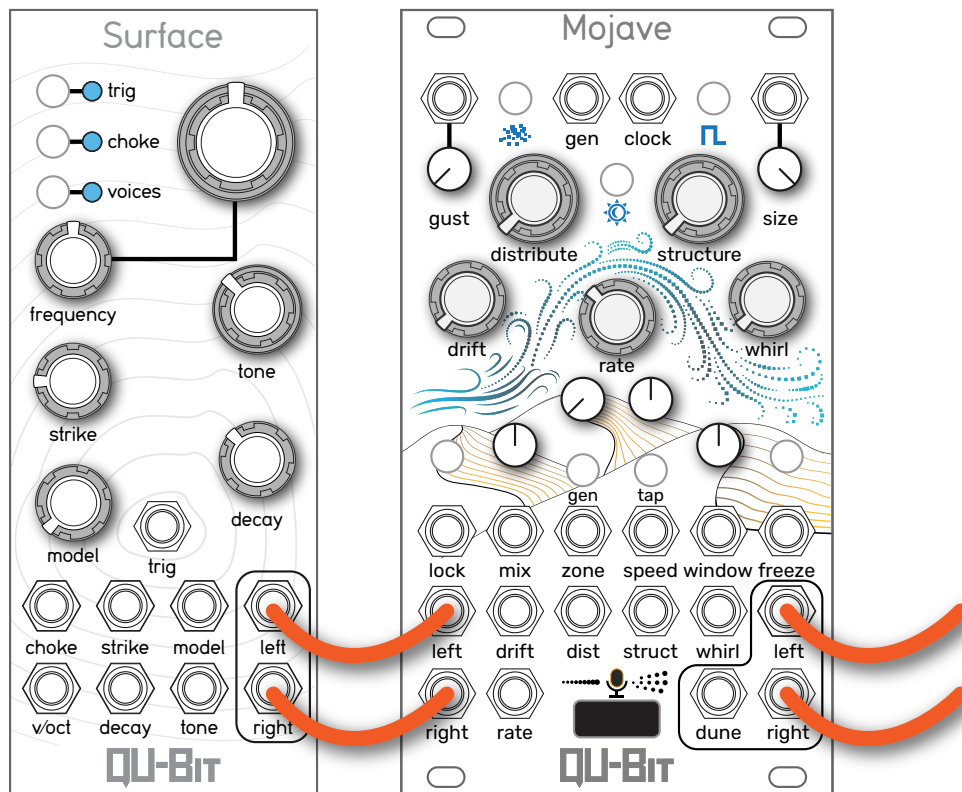

Settings

Clock Mode: Free (default)

Size: Maximum, Forward

Gust: Fully counter-clockwise

Pitch: Original pitch

Who needs an amp for awesome riffy feedback when you have a Mojave! Using the settings above will get you started with Mojave's feedback effect. The key for good feedback is to have a short audio source inputting into Mojave, whether it be a short pluck, or a snappy drum.

From this point, Mojave can manipulate the feedback in multiple ways. Turn up Structure slightly to change the constant feedback tone into an undulating comb-like wash. Turning up Drift will turn Mojave into a feedback echo chamber, while the Speed knob up or down 1 semitone will cause the feedback to run through ascending or descending harmonic series.

Try out each control on Mojave to hear what feedback can do to your sound! And don't forget to check out this patch in action down below!

[Example Video](#)

More Than Sound

The Mojave desert has always been a special place for Qu-Bit team members. A place of rest, a place of renewal, and a place for invigorating the creative mind.

We hope the sonic possibilities of Mojave instill those same feelings in you. With every Mojave sold a portion of the proceeds will go to the [Joshua Tree National Park Association](#), and will help to preserve a portion of the Mojave desert that we hold dear to our hearts.



Lifetime Repair Warranty



Keeping your module patching like it's day one.

No matter how long you've owned your module, or how many people have owned it before you, our doors are open to any and all Qu-Bit modules needing repair. Regardless of circumstances, we will continue to provide physical support for our modules, with all repairs being completely free of charge.*

[Learn more about the lifetime repair warranty.](#)

Changelog

Version	Date	Description
		<ul style="list-style-type: none">• Release firmware.