

Quadrax

(+ Optional Qx Expander)

4-Channel CV-Controllable Function Generator With Cycling, Pulse Burst Generation and Morphing LFO

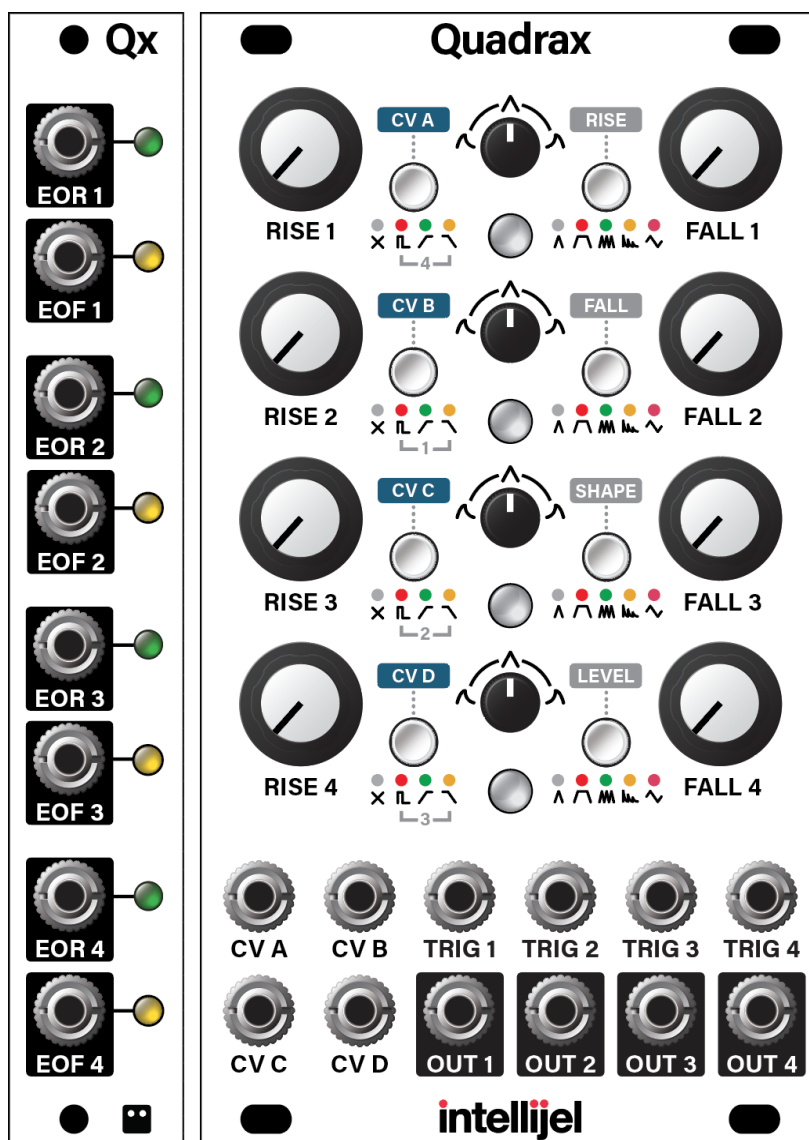

TABLE OF CONTENTS

COMPLIANCE	4
INSTALLATION	5
Installing Your Module	6
Connecting the Optional Qx Expander Module	7
OVERVIEW	8
QUADRAX FRONT PANEL	10
Controls	10
Inputs and Outputs	15
CHANNEL MODE OPTIONS	17
AD Mode	17
AHR Mode	18
CYCLE Mode	19
BURST Mode	19
LFO Mode	20
CHANNEL LINK OPTIONS	21
No Link	21
Trigger Link	22
End Of Rise Link	22
End of Fall Link	23
Multiple Triggers	23
BURST MODE - IN DETAIL	24
LFO MODE - IN DETAIL	27
LFO Mode (STANDARD)	27
Multiple Beat Synchronized LFOs	29
Resetting Phase Sync of all Linked LFOs	29
STANDARD LFO Waveshapes and Morphing	30
LFO Mode (ALTERNATE)	31
MAKING CV ASSIGNMENTS	33
Enter/Exit CV Assignment Mode	33
Programming the CV Matrix	34



CLEARING CV ASSIGNMENTS	37
USING THE OPTIONAL QX MODULE	38
EOR/EOF for AD Mode	38
EOR/EOF for AHR Mode	39
EOR/EOF for CYCLE Mode	39
EOR/EOF for BURST Mode	40
EOR/EOF for LFO Mode	41
UTILITY MODE	42
SYSTEM MODE	43
System Mode Options	43
Burst Retriggering Option	43
Dithering Option	44
CVD (Color Vision Deficiency) Mode	45
Reset to Default	45
FIRMWARE VERSION DISPLAY	46
FIRMWARE CHANGE LOG	47
TECHNICAL SPECIFICATIONS	52

COMPLIANCE



This device complies with Part 15 of the FCC Rules. Operation is subject to the following two conditions: (1) this device may not cause harmful interference, and (2) this device must accept any interference received, including interference that may cause undesired operation.

Changes or modifications not expressly approved by Intellijel Designs, Inc. could void the user's authority to operate the equipment.

Any digital equipment has been tested and found to comply with the limits for a Class A digital device, pursuant to part 15 of the FCC Rules. These limits are designed to provide reasonable protection against harmful interference when the equipment is operated in a commercial environment. This equipment generates, uses, and can radiate radio frequency energy and, if not installed and used in accordance with the instruction manual, may cause harmful interference to radio communications.



This device meets the requirements of the following standards and directives:

EMC: 2014/30/EU
EN55032:2015 ; EN55103-2:2009 (EN55024) ; EN61000-3-2 ;
EN61000-3-3

Low Voltage: 2014/35/EU
EN 60065:2002+A1:2006+A11:2008+A2:2010+A12:2011

RoHS2: 2011/65/EU

WEEE: 2012/19/EU

INSTALLATION

Intellijel Eurorack modules are designed to be used with a Eurorack-compatible case and power supply. We recommend you use Intellijel cases and power supplies.

Before installing a new module in your case, you must ensure your power supply has a free power header and sufficient available capacity to power the module:

- Sum up the specified +12V current draw for all modules, including the new one. Do the same for the -12 V and +5V current draw. The current draw will be specified in the manufacturer's technical specifications for each module.
- Compare each of the sums to specifications for your case's power supply.
- Only proceed with installation if none of the values exceeds the power supply's specifications. Otherwise you must remove modules to free up capacity or upgrade your power supply.

You will also need to ensure your case has enough free space (hp) to fit the new module. To prevent screws or other debris from falling into the case and shorting any electrical contacts, not leave gaps between adjacent modules, and cover all unused areas with blank panels. Similarly, do not use open frames or any other enclosure that exposes the backside of any module or the power distribution board.

You can use a tool like [ModularGrid](#) to assist in your planning. Failure to adequately power your modules may result in damage to your modules or power supply. If you are unsure, please [contact us](#) before proceeding.

Installing Your Module

When installing or removing a module from your case always turn off the power to the case and disconnect the power cable. Failure to do so may result in serious injury or equipment damage.

Ensure the 10-pin connector on the power cable is connected correctly to the module before proceeding. The red stripe on the cable must line up with the -12V pins on the module's power connector. Different modules use different ways to indicate the -12V pins. Some may be labelled with "-12V," a white stripe next to the -12V pins; the words "red stripe;" or some combination of these. Additionally, some modules may have shrouded headers, thus preventing backward connections.

Most modules will come with the cable already connected but it is good to double check the orientation. Be aware that some modules may have headers that serve other purposes so ensure the power cable is connected to the right one.

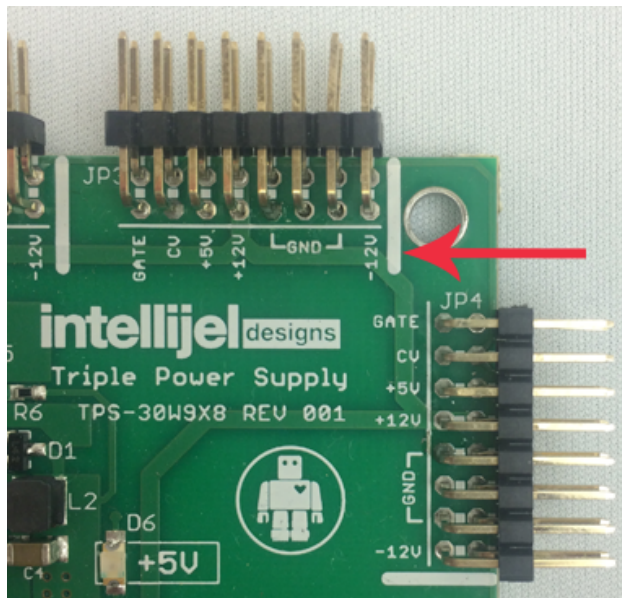
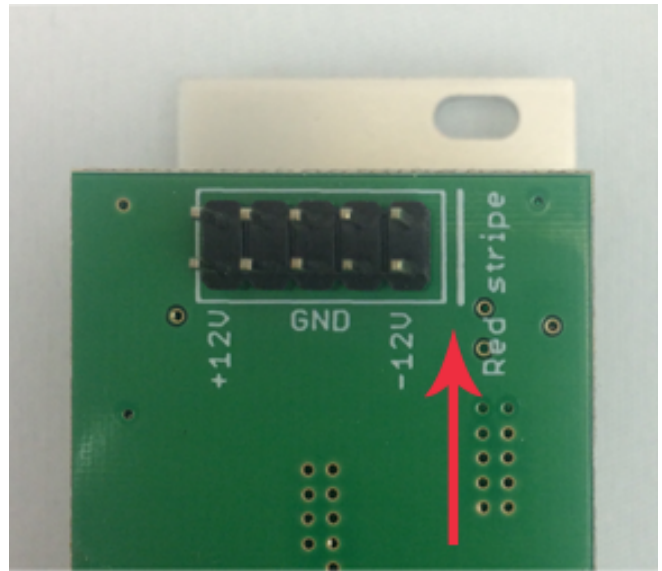

The other end of the cable, with a 16-pin connector, connects to the power bus board of your Eurorack case. Ensure the red stripe on the cable lines up with the -12V pins on the bus board. On Intellijel power supplies the pins are labelled with the label "-12V" and a thick white stripe:

If you are using another manufacturer's power supply, check their documentation for instructions.

Once connected, the cabling between the module and power supply should resemble the picture below:

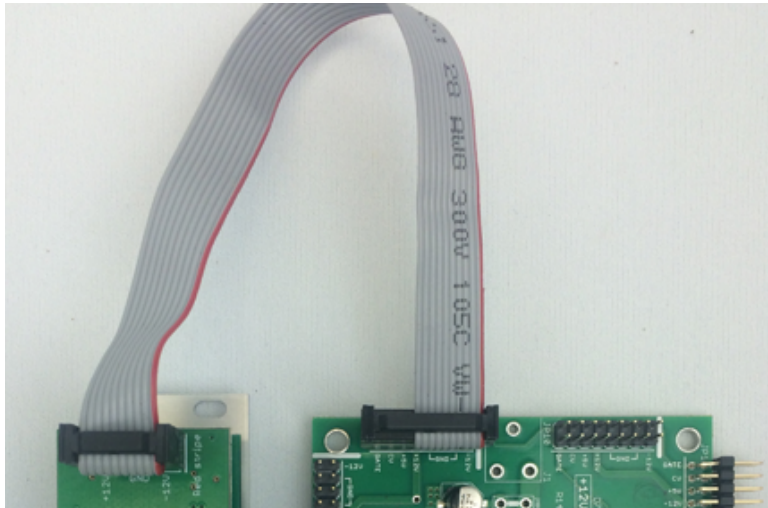

Before reconnecting power and turning on your modular system, double check that the ribbon cable is fully seated on both ends and that all the pins are correctly aligned. If the pins are misaligned in any direction or the ribbon is backwards you can cause damage to your module, power supply, or other modules.

After you have confirmed all the connections, you can reconnect the power cable and turn on your modular system. You should immediately

check that all your modules have powered on and are functioning correctly. If you notice any anomalies, turn your system off right away and check your cabling again for mistakes.

Connecting the Optional Qx Expander Module

Connect the power cable between the 10-pin Qx power connector and one 16-pin power socket on your eurorack system's powered bus board as described above.

Using the I2C cable supplied with your Qx module, connect one end to the 6-pin I2C connector on the Qx and the other end to either of the two I2C ports on your Quadrax module (it doesn't matter which of Quadrax's two I2C ports you use). Be sure to align the red stripe with the white line on the Qx circuit board.

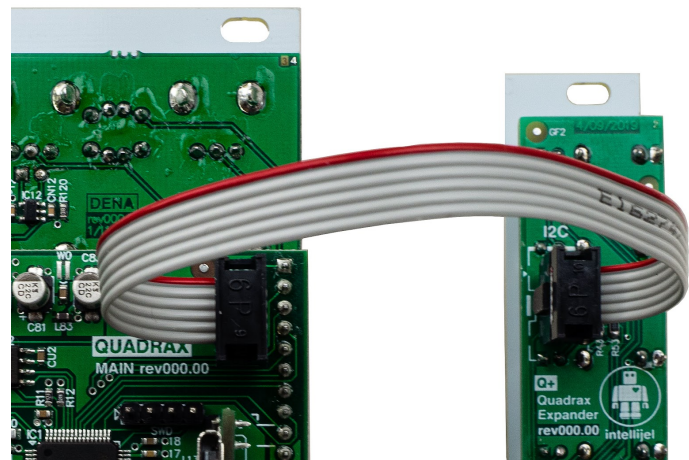

IMPORTANT! : Always power down the modules before connecting or disconnecting an I2C cable.

NOTE: You can also use an IntelliJ Gx module in place of a Qx. It functions identically, only the Gx has generic output labels (1-8), rather than the Quadrax-specific EOR/EOF output labels.

OVERVIEW

The Intellijel Quadrax consists of four independent, CV-controllable channels, each of which can be configured to perform any one of the following functions:

- an AD (Attack, Decay) envelope
- an AHR (Attack, Hold, Release) envelope
- a cycling envelope (resulting in a unipolar LFO)
- a pulse burst generator
- a morphing, bipolar LFO (plus a chaotic Low Frequency Vacillator)

The envelopes all feature a continuously variable response curve, ranging from logarithmic through linear to exponential, and a stage can be as snappy as 0.05 ms to as lengthy as 20 seconds.

When set to Burst mode, the channel generates a rising or falling burst of pulses, with full control over the length of the pulse burst, and the rate and shape of the bursts within it, along with whether the bursts increase or decrease in amplitude over the burst length.

AD, AHR, Cycling and Burst modes have a user-selectable maximum output level of either 5V or 10V, and can be attenuated (per channel) for modulating other modules that lack attenuators.

LFO mode offers control over the frequency and waveshape, while providing a unique morphing feature that creates numerous variations of the selected waveshape. LFOs can be either free-running or beat-synchronized using the channel's TRIG input.

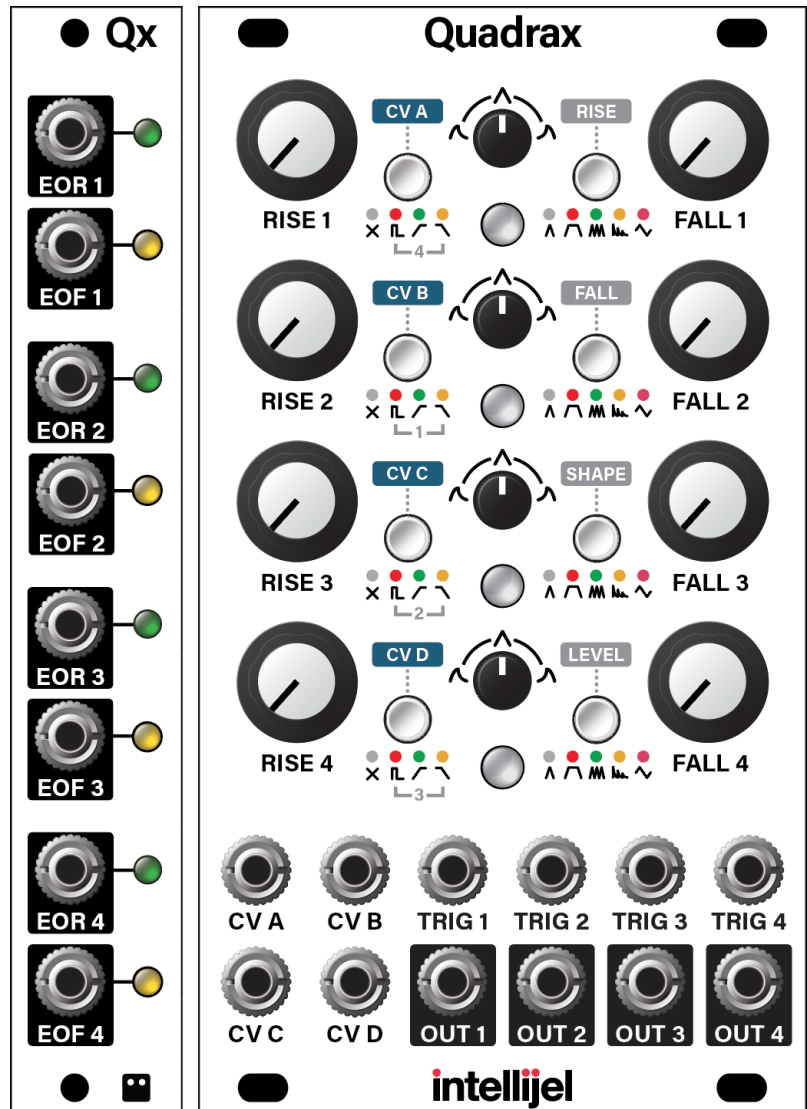

Each of the five modes (AD, AHR, Cycling, Burst and LFO) provide both *standard* and *alternate* modes of operation, giving you even more nuanced control. Specifically, the alternate functionality for AD, AHR and CYCLE modes changes the response curves of the envelope — enabling RISE to have a logarithmic shape while FALL's shape is exponential, and vice-versa. BURST Mode's alternate function replaces the square/sine shape with a tilting sawtooth shape. The alternate LFO operation enables a chaotic voltage source (which we call a "Low Frequency Vacillator (LFV)", and the knobs control the rate of vacillations, along with the per-cycle variance and the amount it's slewed.

Channels can be chained together to create complex multi-stage envelopes, with each channel triggered by the previous channel's trigger input, end-of-rise, or end-of-fall. This enables multiple function generators to fire simultaneously, or it enables the creation of complex multi-stage envelopes by allowing the linked function to fire either at the end of the previous function's rise time, or at the end of its fall time.

Four freely-assignable, step-attenuverted CV inputs are capable of modulating any or all of the various parameters across all four channels using the built-in CV matrix, with built-in attenuation for each assignment.

1 v/oct CV inputs enable you to use LFO and Burst modes as oscillators.

Quadrax remembers its current state (Mode and CV assignments, channel links, etc) and retains that state even if power is removed, meaning Quadrax will always turn on in exactly the same state as you last left it.

Use the optional Qx module to add individual outputs for each channel's End-of-Rise and End-of-Fall triggers.

QUADRAX FRONT PANEL

Controls

[1] RISE (x4) - Each channel has its own RISE knob, whose function depends on the channel's mode assignment, as selected by the MODE/DESTINATION button **[6]**.

- **AD, AHR and CYCLE** modes: This knob controls the rise time (attack) of the function (rising from zero to the maximum level). Slower times will create a fade-in effect while faster times are used for snappy percussive sounds.

When fully counterclockwise, rise time is nearly instantaneous (about 0.05 ms), slowing to about 50 ms at the 'noon' position. Rotating past noon results in increasingly lethargic rise times, up to about 20 seconds when fully clockwise.

- **BURST Mode:** The RISE knobs sets the rate at which pulses are generated within the burst envelope.

When the RISE knob is fully counter-clockwise, Quadrax generates pulses at a rate of 0.05 Hz, and when fully counterclockwise at about 3.33 kHz.

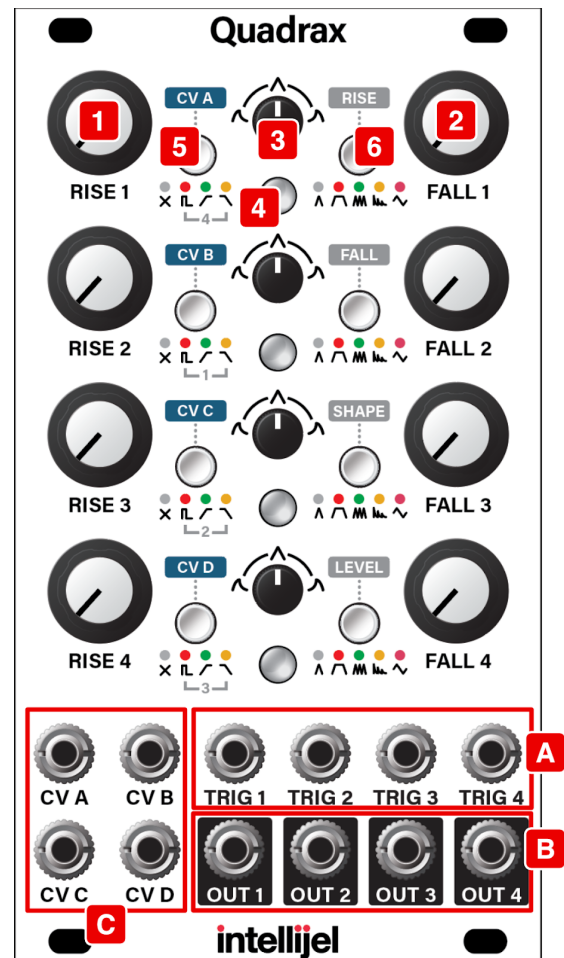

See [BURST Mode - In Detail](#) later in this manual for more information.



- **LFO Mode:** The RISE knob functions as a RATE knob for the LFO.

With nothing patched into the TRIG input, the LFO is free-running and the knob sets the LFO rate from 0.05 Hz (20 sec) when fully counterclockwise to around 3.33 kHz (0.3 ms) when fully clockwise. Using CV extends the range even further.

If you patch a clock into the TRIG input, the LFO will synchronize to the clock, and the RISE knob changes the multiplication/division of the incoming clock. At the 'noon' position, the rate equals the incoming clock. Rotating the knob counterclockwise divides the clock, achieving a rate 1/64 of the clock rate when fully counterclockwise. Rotating the knob clockwise multiplies the clock rate, achieving a rate 64 times faster than the incoming clock when fully clockwise. For more information about LFO Mode, see [LFO Mode](#), later.

- [2] **FALL (x4)** - Each channel has its own FALL knob, whose function depends on the channel's mode assignment, as selected by the MODE/DESTINATION [6] button.

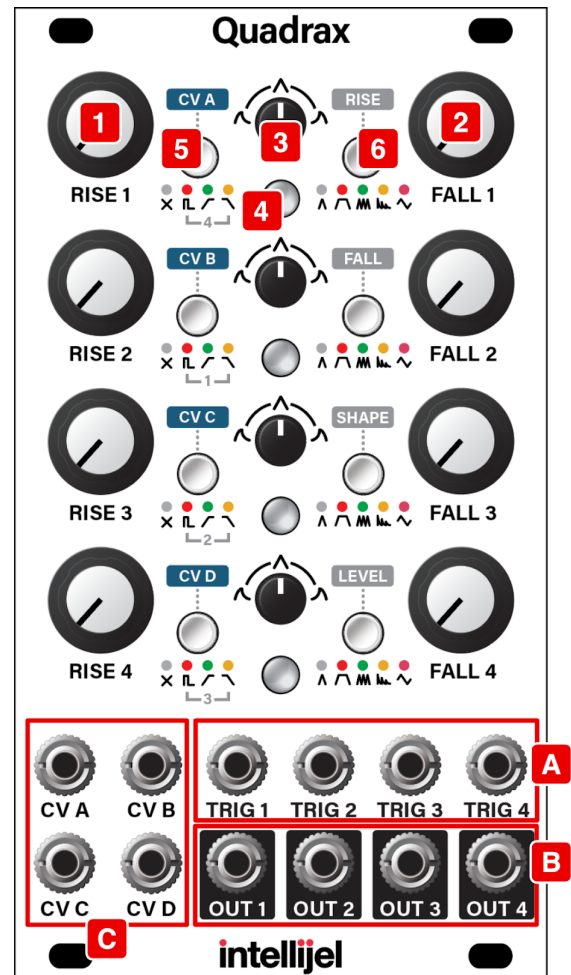

- **AD, AHR and CYCLE** modes: Sets the amount of time it takes for the function to fall from its maximum value back to zero. In AHR mode this will act as the release time. In Cycle mode the total time of RISE plus FALL sets the frequency of the cycle.

When fully counterclockwise, fall time is about 0.05 ms (for AD and AHR envelopes), slowing to about 50 ms at the 'noon' position. Rotating past noon results in increasingly lethargic fall times, up to about 20 sec when fully clockwise.

- **BURST** Mode: The FALL knob sets the overall length of the pulse burst envelope.

Rotating the knob increases the length of the pulse burst from about 0.3 ms when fully counterclockwise to around 20 seconds when fully clockwise. Using CV extends the range even further.

- **LFO** Mode: The FALL knob becomes a MORPH knob (for a STANDARD LFO), and is used to create numerous interesting and morphable variations on the basic waveform set by the SHAPE [3] knob. For the ALTERNATE LFO (a Low Frequency Vacillator), the FALL knob becomes a VARIANCE knob, setting the maximum amount of variance for each vacillation. These are detailed in the [Standard LFO Waveshapes and Morphing](#) section, later in this manual).



[3] SHAPE (x4) - Each channel has its own SHAPE knob, whose function depends on the channel's mode assignment, as selected by the **MODE/DESTINATION** button **[6]**.

- In **AD**, **AHR** and **CYCLE** modes: This knob changes the shape of the RISE and FALL curves.

At the 'noon' position, the curves are linear, which is traditionally the shape used to control exponential VCAs.

Other shapes depend on whether the AD, AHR and CYCLE modes are set to **STANDARD** or **ALTERNATE** operation (toggled by long-pressing (>1 sec) the **MODE/DESTINATION** **[6]** button).

In STANDARD operation: Rotating the knob *clockwise* from center results in an increasingly exponential shape. This is the curve found on many classic envelope generators, and is traditionally used to control linear VCAs. Exponential shapes tend to have more of a plucked character.

Rotating the knob *counterclockwise* from center results in an increasingly logarithmic shape.

IN ALTERNATE operation: Rotating the knob *clockwise* from center results in an increasingly spikey shape, since an exponential curve is applied to the attack stage, and a logarithmic curve is applied to the decay/release stage.

Rotating the knob *counterclockwise* from center results in a gradual, bell-like shape, since a logarithmic curve is applied to the attack stage, and an exponential curve is applied to the decay/release stage.

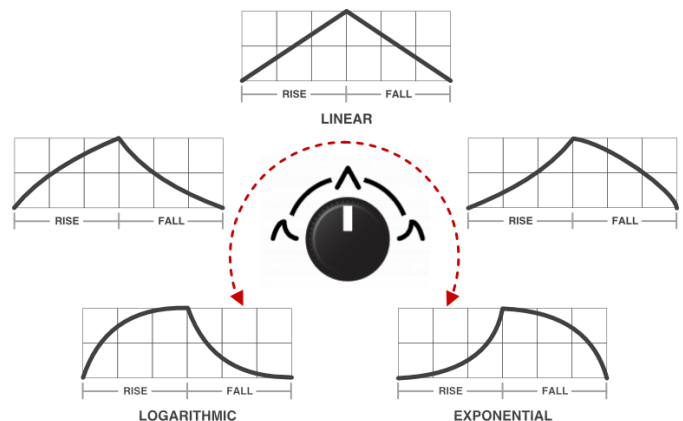

VARIABLE RESPONSE CURVES - STANDARD MODE

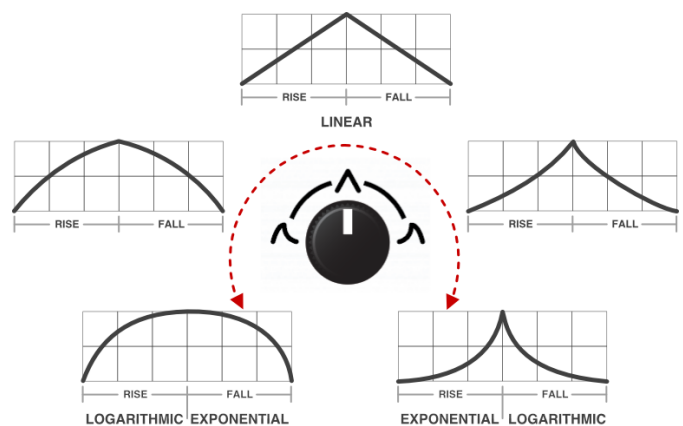

VARIABLE RESPONSE CURVES - ALTERNATE MODE



- In **BURST Mode**: The knob shapes the overall burst envelope plus the waveform of each pulse within that envelope. For more information, see [BURST Mode - In Detail](#), later in this manual.
- In **LFO Mode**: The knob controls the LFO shape, which is further defined by the FALL [2] knob. LFO Mode's interaction of these two knobs is discussed in [LFO Mode - In Detail](#), later in this manual.

[4] **LED** - The brighter this LED (x4), the higher the corresponding function generator's amplitude. If the LED is **green**, then the function is generating a positive voltage. A **red** LED indicates a negative voltage.

[5] **LINK/CV** button - This button (x4) has two functions, LINK and CV ASSIGN.

- **LINK**: The button's primary function (as indicated by the graphics beneath) is to determine whether or not the prior channel triggers this channel and, if so, how. Specifically, the LINK button on Channel 2 determines if/how it's triggered by Channel 1; Channel 3's button determines if/how it's triggered by Channel 2; and Channel 4's button determines if/how it's triggered by Channel 3. Channel 1's button determines if/how it's triggered by Channel 4. Push a channel's LINK button repeatedly to cycle through the various triggering options. See [Channel Link Options](#) for more information.
- **CV ASSIGN**: The button's secondary function (as indicated by the label above it) is to assign the four CV inputs to one or more destinations for each channel. Long-press the LINK/CV button to enter CV Assignment mode. See [Making CV Assignments](#) for more information.

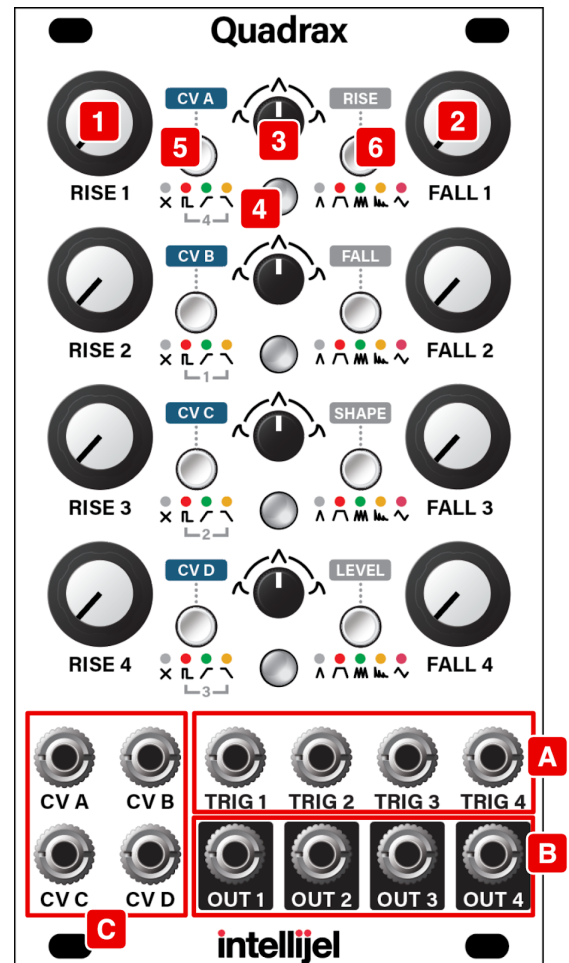

[6] MODE/DESTINATION button - This button (x4) has several functions: In normal operation, it selects the channel's MODE, while in CV Assignment mode, it sets the DESTINATION (and attenuversion) of the CV input. Additionally, long-pressing the button toggles the current mode between its STANDARD functionality and its ALTERNATE functionality.

When used as a MODE button, it sets each channel to one of five modes. Push it repeatedly to cycle through the various mode options, which are:

- **AD:** Attack/Decay envelope, where RISE controls the envelope's attack time and FALL controls the decay time. AD envelopes complete their entire cycle upon receiving a trigger at the corresponding TRIG input. AD envelopes ignore the gate time of the incoming signal.
- **AHR:** Attack/Hold/Release envelope, where RISE controls the envelope's attack time and FALL controls its release time. The attack portion of the envelope is triggered by the rising edge of a gate signal sent to the corresponding TRIG input. The envelope holds (sustains) its maximum value for as long as the gate signal is high, then triggers the release stage when the gate signal goes low.
- **CYCLE:** Cycle mode behaves like a unipolar LFO, with the RISE and FALL times determining the rate and shape of the LFO.
- **Burst:** Burst mode generates a series of pulses that repeat at a variable rate (set the the RISE knob) within a length of time (set by the FALL knob), whose pulse shapes and overall amplitude curve are defined with the SHAPE knob. This mode is discussed thoroughly in [BURST Mode - In Detail](#), later in this manual.
- **LFO:** LFO mode turns a channel into a bipolar, beat-syncable LFO with multiple basic waveshapes and some advanced waveshape morphing capabilities. This mode is discussed thoroughly in [LFO Mode - In Detail](#), later in this manual.

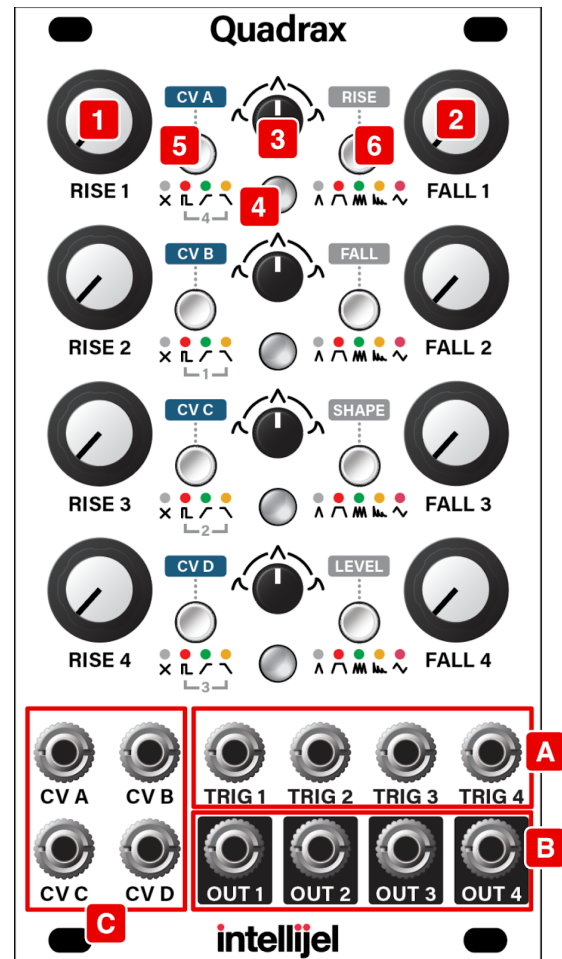

Once in a MODE, long-press (>1 sec) the **MODE/DESTINATION** button to toggle between STANDARD operation and ALTERNATE operation, as described later in [LFO Mode - In Detail](#).

In CV Assignment mode, this button assigns destinations to CV inputs, and controls the amount of attenuation applied. The brighter the button, the more a CV input affects a destination, with green indicating positive modulation and red indicating negative modulation. The operation of the DESTINATION button is described fully in [Making CV Assignments](#).

Inputs and Outputs

[A] TRIG Inputs (x4) - Patch a trigger or gate signal here to launch the function generator. There are four TRIG inputs — one for each of the four function generators.

In LFO mode, the TRIG input functions as a clock input, and the RISE (RATE) knob functions as a clock divider/multiplier, allowing beat-synchronized LFOs. Because the TRIG inputs have jack detection, you can have free-running LFOs by simply leaving the TRIG input disconnected.

[B] OUTS (x4) - Outputs for each of the four channel function generators.

Channels assigned to **AD**, **AHR**, **CYCLE** or **BURST** modes generate a unipolar voltage, which you can set to a maximum of either 5V or 10V and also attenuated (for driving other modules without built-in attenuators). Use [Utility Mode](#) (detailed later) to set the desired output voltage for each channel.

Channels assigned to **LFO** output $\pm 5V$ bipolar signals, but can also be attenuated using [Utility Mode](#).

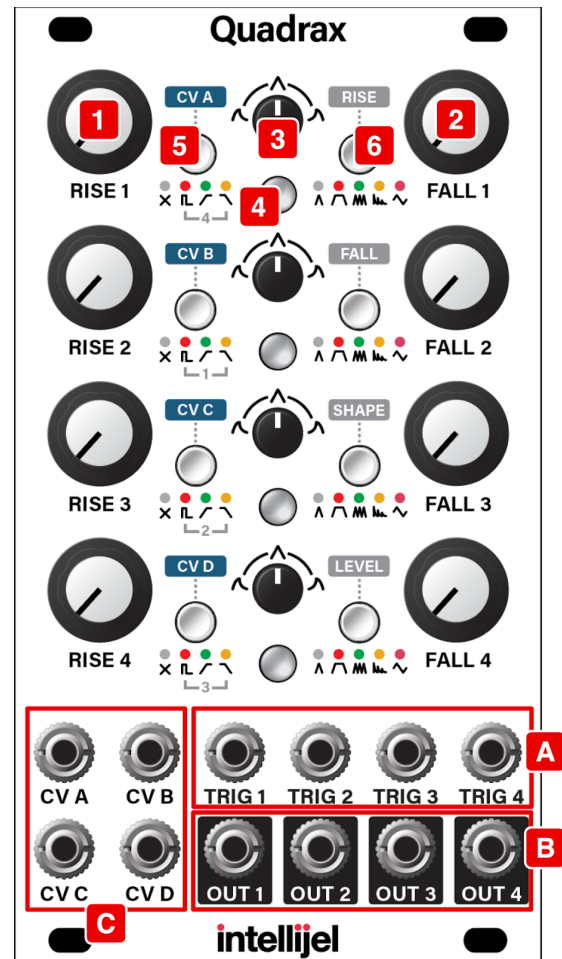

[C] CV Inputs (x4) - Patch control voltages into each jack to modulate one or more user-definable parameters for any or all of the four channels. Each CV input can control multiple destinations, and with varying amounts of attenuation for each.

CV inputs track 1 v/oct, so (for STANDARD LFO and BURST modes), it's possible to use Quadrax as an oscillator by sending pitch CV to a CV input, and using it to control the RISE function).

For more information about CV inputs and how to make assignments, see [Making CV Assignments](#), later in this manual.

NOTE: Although the range of CV modulation is $\pm 5V$, the CV inputs accept voltages up to $\pm 10V$. Any voltages above or below 5V are simply clipped at $\pm 5V$. Use Quadrax's internal attenuverters (as described in [Programming the CV Matrix](#)) to dial down the input voltages.

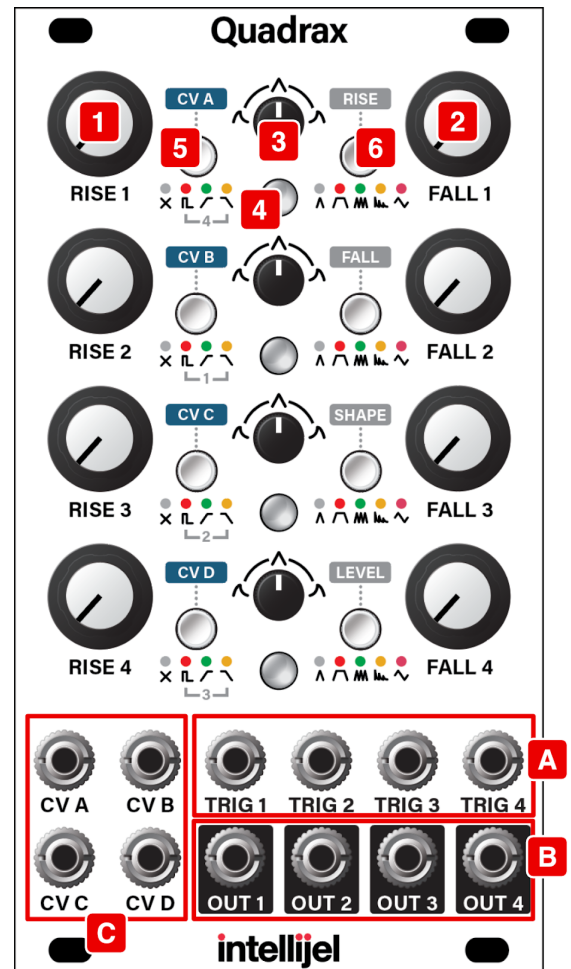

CHANNEL MODE OPTIONS

Each of Quadrax's four channels can be assigned to operate in one of five modes: Pushing the MODE button repeatedly cycles through the various mode options.

AD Mode

When the **MODE [6]** button is unlit, the channel is a classic, 2-stage Attack/Decay envelope, where **RISE** controls the envelope's attack time and **FALL** controls the decay time. AD envelopes complete their entire cycle upon receiving a trigger at the corresponding **TRIG** input. AD envelopes ignore the gate time of the incoming signal.

In **STANDARD** operation, the **RISE** and **FALL** curves are logarithmic when the **SHAPE [3]** knob is counter-clockwise from center, and exponential when it's clockwise from center.

In **ALTERNATE** operation, the **RISE** curve is logarithmic and the **FALL** curve is exponential whenever the **SHAPE [3]** knob is counter-clockwise from center. When it's clockwise from center, the curves are reversed, such that **RISE** is exponential and **FALL** is logarithmic.

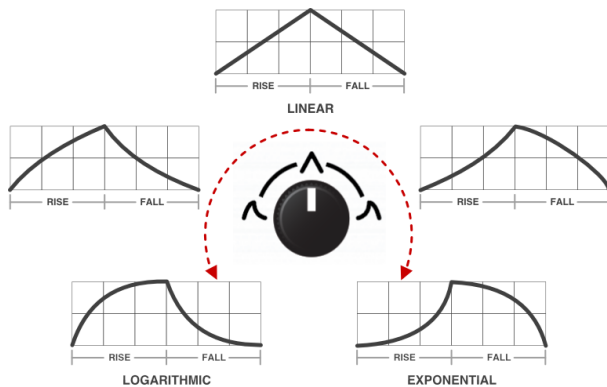
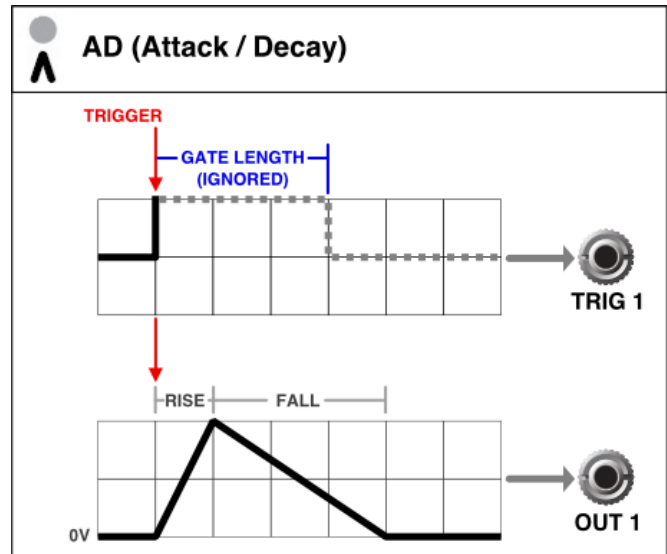

VARIABLE RESPONSE CURVES - STANDARD MODE

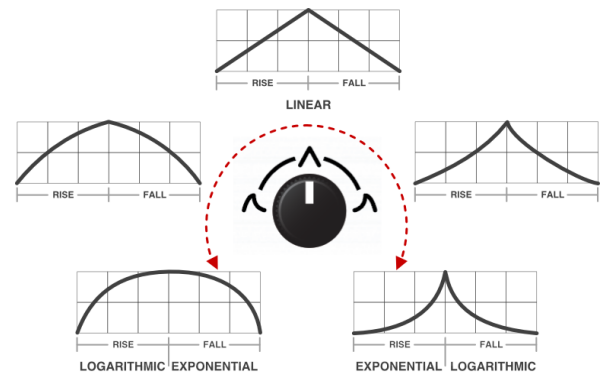

VARIABLE RESPONSE CURVES - ALTERNATE MODE

To toggle between **STANDARD** and **ALTERNATE** operation, long-press (>1 sec) the channel's **MODE/DESTINATION [2]** button. The button will pulse when the **ALTERNATE** operation is enabled.

AHR Mode

When the MODE button is **red**, the channel acts as an Attack/Hold/Release envelope, where **RISE** controls the envelope's attack time and **FALL** controls its release time. The attack portion of the envelope is triggered by the rising edge of a gate signal sent to the corresponding **TRIG** input. The envelope holds (sustains) its maximum value for as long as the gate signal is high, then triggers the release stage when the gate signal goes low. If the gate length is shorter than the rise time, the envelope will begin to fall before reaching its maximum value.

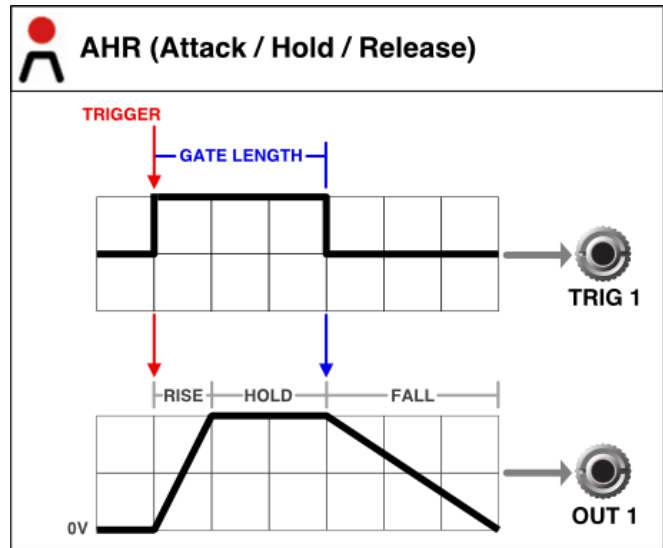

ALTERNATE operation: As with [AD Mode](#)

*(discussed above), AHR Mode also supports both STANDARD and ALTERNATE operation. With AHR Mode active, toggle ALTERNATE on/off by long-pressing the **MODE/DESTINATION** [2] button. The button will pulse when the ALTERNATE operation is enabled, which alters the **SHAPE** [3] knob's choice of response curves exactly as described above. Specifically:*

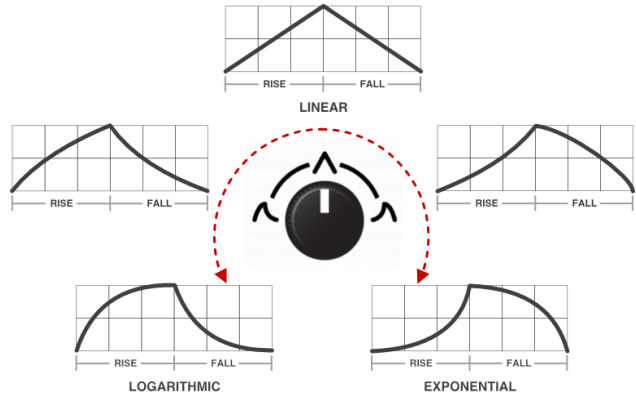

VARIABLE RESPONSE CURVES - STANDARD MODE

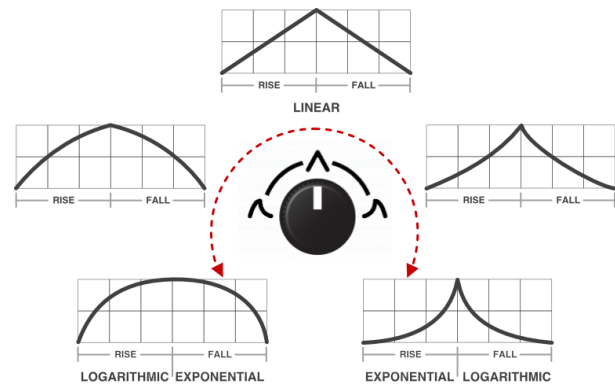

VARIABLE RESPONSE CURVES - ALTERNATE MODE

CYCLE Mode

When the MODE button is **green**, the channel produces a cycling AD envelope, which behaves like a unipolar LFO. The frequency of the cycle is determined by the overall sum of the **RISE** and **FALL** times. The skewing of the cycle is determined by the relative amounts of RISE and FALL, while the curvature is selected by the **SHAPE** knob.

The Cycle is free running, and does not require a **TRIG** input. However, if a TRIG input is detected, then the Cycle resets, as shown in the graphic to the right. GATE times are ignored.

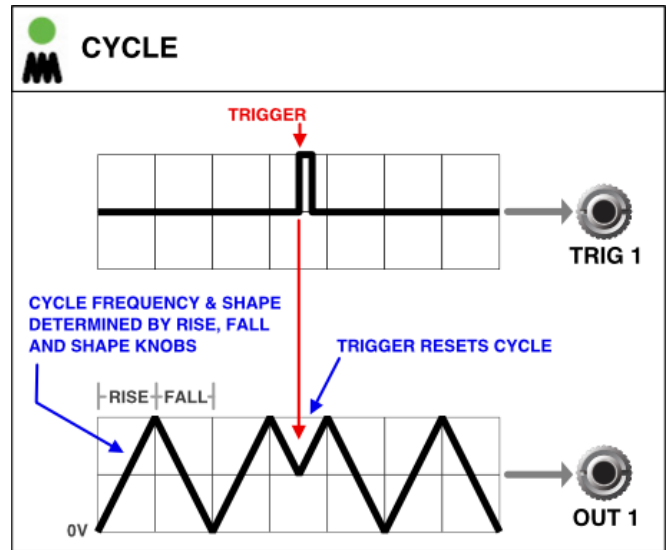

*ALTERNATE operation: As with [AD Mode](#) and [AHR Modes](#) (both discussed previously), CYCLE Mode also supports both STANDARD and ALTERNATE operations. Toggle ALTERNATE on/off by long-pressing the **MODE/DESTINATION [2]** button. The button will pulse when the ALTERNATE operation is enabled, which alters the **SHAPE [3]** knob's choice of response curves exactly as described in those two modes.*

BURST Mode

When the MODE button is **yellow**, the channel operates in BURST mode. Burst mode generates pulses at a programmable rate (using the **RISE [1]** knob) within a programmable length of time (using the **FALL [2]** knob), whose shape and amplitude curve are defined with the **SHAPE [3]** knob.

For more information, see [Burst Mode - In Detail](#), later in this manual.

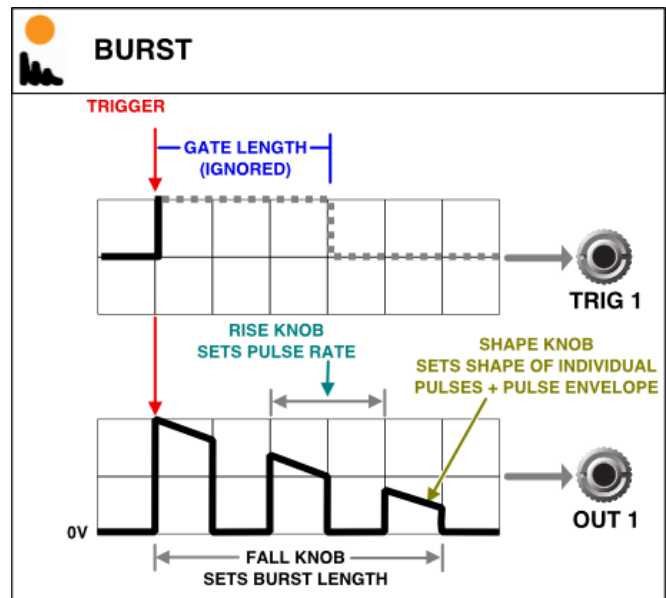

LFO Mode

When the MODE button is **magenta**, the channel operates in LFO mode. In this mode, the channel becomes a bipolar LFO, with the RISE knob controlling LFO **RATE**, the SHAPE knob selecting **WAVESHAVE**, and the FALL knob controlling a **MORPH** function that varies the waveshape. For more information, see [LFO Mode - In Detail](#) later in this manual.

LFOs can be beat-synchronized using the channel's TRIG input, or they can be free-running if the TRIG input is left unpatched.

Clocked LFO: Send a clock to the channel's TRIG input and use the RATE (RISE) knob to multiply or divide that rate by as much as 64x in either direction. With the RATE knob straight up ('noon' position), the LFO rate equals the clock rate.

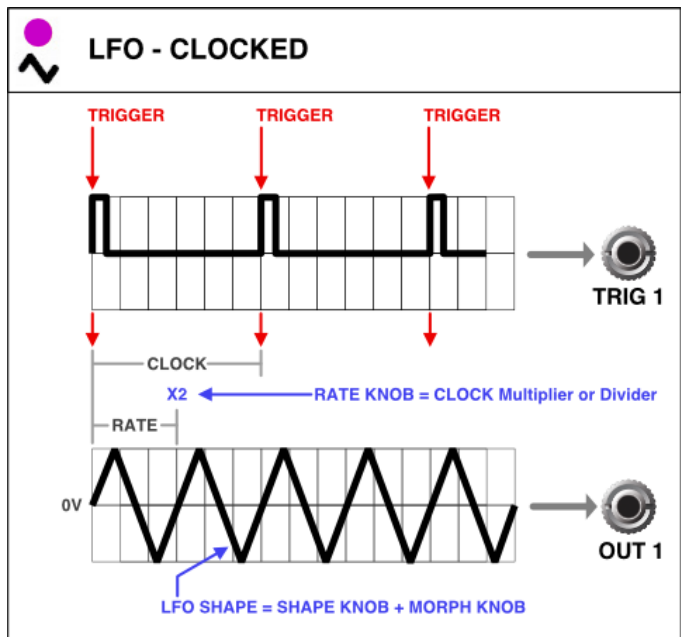

Unclocked LFO: Leave the channel's TRIG input unpatched and use the RATE (RISE) knob to dial in the desired free-running rate. LFO frequency can be set from 0.05 Hz (20 sec) when fully counterclockwise to around 3.33 kHz (0.30 ms) when fully clockwise. Using CV extends the range even further.

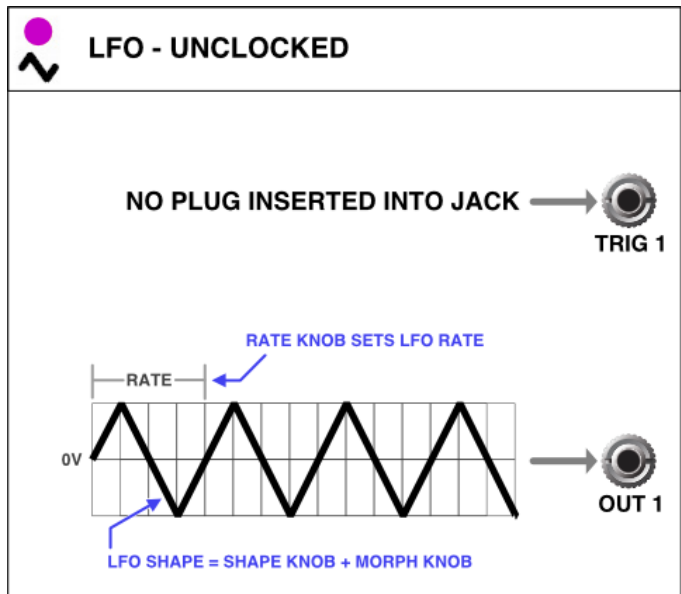

CHANNEL LINK OPTIONS

Though it's perfectly acceptable to think of Quadrax as four completely independent function generators, the module features several ways to link these channels together. Use the LINK button (together with the TRIG inputs) to fire off multiple functions with a single trigger/gate, or to create complex envelope shapes and rhythms using multiple triggers. Pushing the LINK button repeatedly cycles through the various channel link options.

No Link

When the LINK button is unlit, channel triggering is completely independent of the channel that precedes it, and is controlled entirely by its own TRIG input.

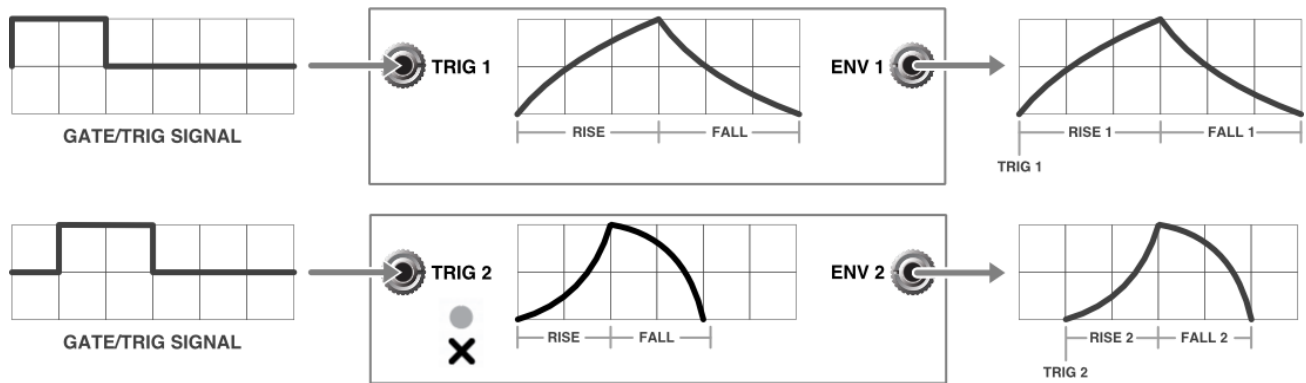

Trigger Link

When the LINK button is **red**, channel triggering/gating is normalled to the previous envelope's TRIG input. This lets you trigger/gate two entirely different functions with a single trigger/gate, which is useful (for example) when you want a keyboard or sequencer to trigger multiple envelopes with a single note event (such as one envelope for your VCA and a second envelope for your filter).

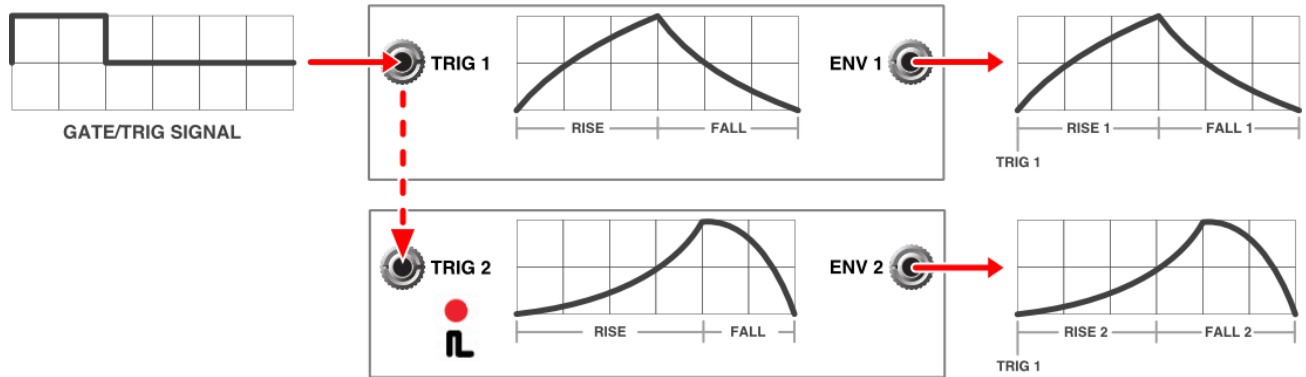

End Of Rise Link

When the LINK button is **green**, the channel is triggered when the previous channel's function completes its RISE time.

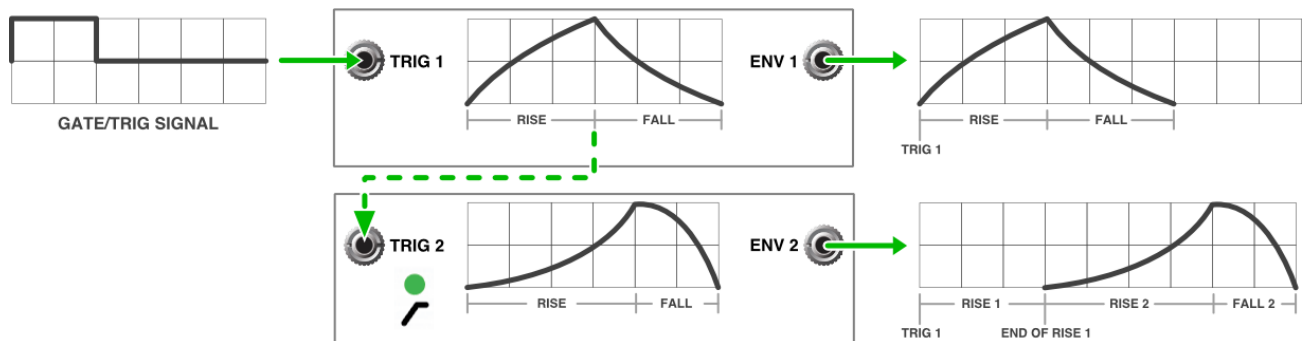

While the meaning of “End of Rise” (EOR) is obvious for envelope-based functions (such as AD, AHR and CYCLE), it may be less obvious how a channel is triggered by the EOR of a [BURST](#) or [LFO](#) channel. BURST mode triggers an EOR at the beginning of every pulse within the burst. STANDARD LFO mode triggers an EOR every time the LFO completes half its cycle, while in ALTERNATE LFO mode, the EOR is high whenever the LFO voltage is moving in a negative direction. For a complete description of exactly when EOR and EOF are triggered for each of Quadrax's five modes, see [Using the Optional Qx Module](#), later in this chapter.

End of Fall Link

When the LINK button is **yellow**, the channel is triggered when the previous channel's function completes its FALL time.

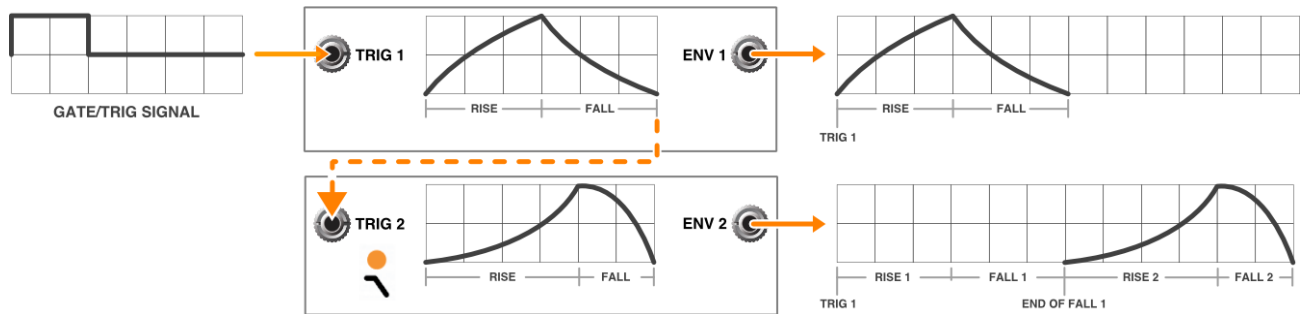

While the meaning of “End of Fall” (EOF) is obvious for envelope-based functions (such as AD, AHR and CYCLE), it may be less obvious how a channel is triggered by the EOF of a [BURST](#) or [LFO](#) channel. BURST mode triggers an EOF at the end of every burst length. STANDARD LFO mode triggers an EOF every time the LFO completes a full cycle, while in ALTERNATE LFO mode, the EOF is high whenever the LFO voltage is moving in a positive direction. For a complete description of exactly when EOR and EOF are triggered for each of Quadrax’s five modes, see [Using the Optional Qx Module](#), later in this chapter.

Multiple Triggers

If you use one of the linked triggering options combined with the channel’s own TRIG input, then the two trigger sources are OR’d together — meaning the function will fire whenever it gets a trigger signal from its own TRIG input as well as from the previous channel.

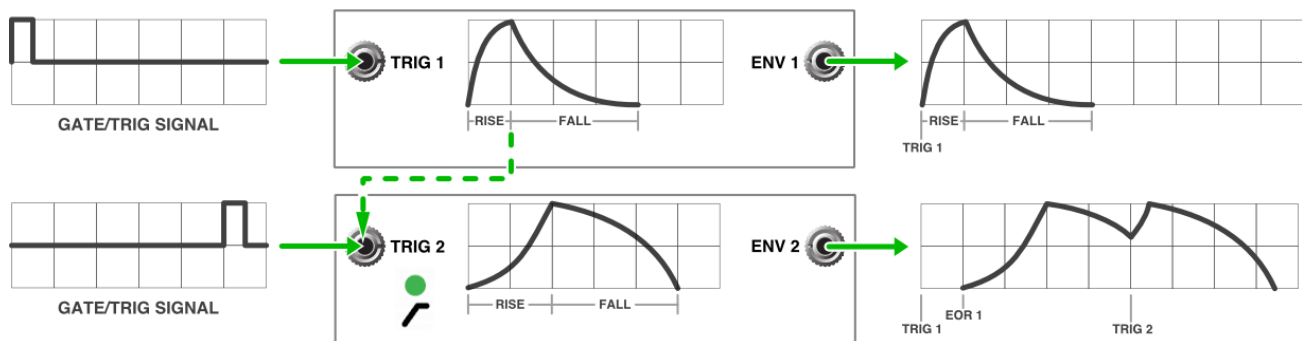

BURST MODE - IN DETAIL

Repeatedly press the **MODE** button [6] to cycle through the various channel modes, stopping when the button turns **yellow** (indicating Burst Mode). When set to Burst Mode, the channel generates a rising and/or falling burst of pulses, which appears at the channel's corresponding **OUT** [B] jack.

The channel's **TRIG** input [A] triggers the pulse burst.

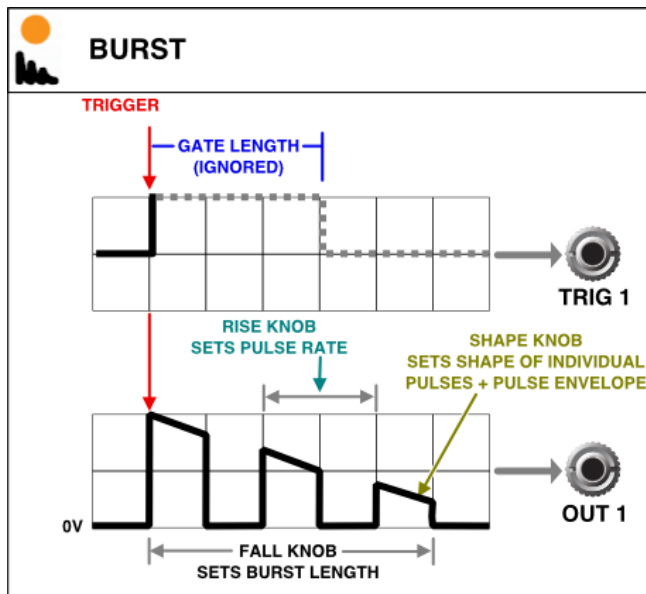

In Burst Mode, Quadrax's controls take on the following functions:

[1] RISE (PULSES) knob: In Burst Mode, the RISE knob functions as RATE knob. It sets the rate at which the pulses repeat during the length of the pulse burst. When the RISE knob is fully counter-clockwise, Quadrax generates pulses at a rate of 0.05 Hz, and when fully counterclockwise at about 3.33 kHz.

[2] FALL (LENGTH) knob: In Burst Mode, the FALL knob functions as the LENGTH knob. It sets the length of the pulse burst envelope. Rotating the knob clockwise increases the length of the pulse burst from about 0.3 ms when fully counterclockwise to around 20 seconds when fully clockwise. Using CV extends the range even further.

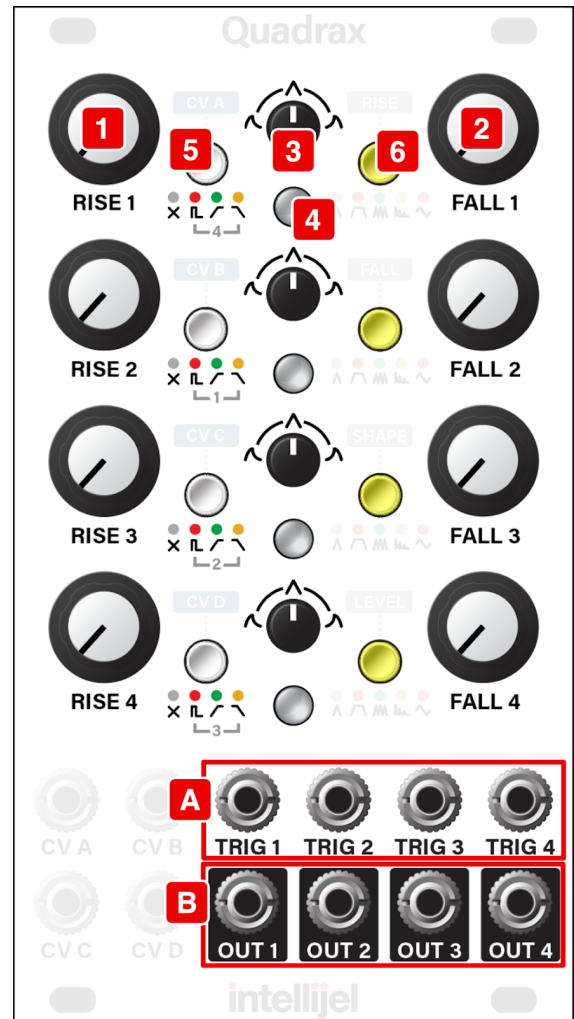

[3] SHAPE knob: In Burst Mode, the SHAPE knob adjusts the attack and decay of the overall burst envelope, plus it alters the waveform of each pulse within that envelope.

With the knob in the counterclockwise position, individual pulse amplitudes decrease over the burst length. With the knob in the clockwise position, individual pulse amplitudes rise over the burst length. At the noon position, maximum pulse amplitude occurs at the midpoint of the burst envelope. The amplitude of the highest pulse is equal to Quadrax’s maximum voltage (as set in [Utility Mode](#)).

The SHAPE knob also changes the pulse shape between square and sine (in STANDARD functionality), and between sawtooth, triangle and ramp (in ALTERNATE operation). Specifically:

- STANDARD operation:** generates square waves at either extreme that switch to sine waves through the middle of the sweep. Notice that the envelope tilts as you rotate the knob, with instantaneous attack occurring with the knob fully counterclockwise; instantaneous decay when fully clockwise; and equal attack and decay at noon.

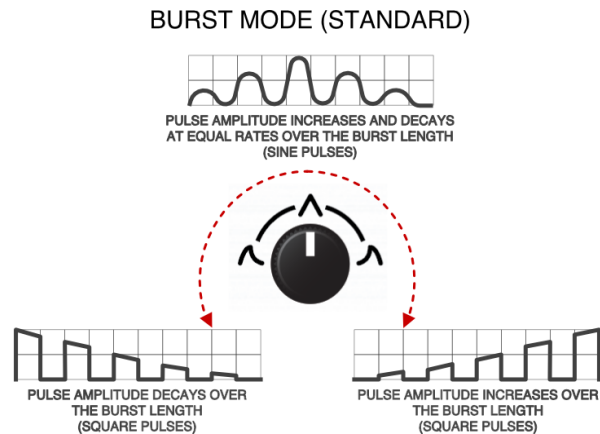

- ALTERNATE operation:** similar to STANDARD function, except the pulse waveform is a sawtooth wave when fully counterclockwise; tilting into a triangle at the noon position; then tilting further into a ramp when fully clockwise.

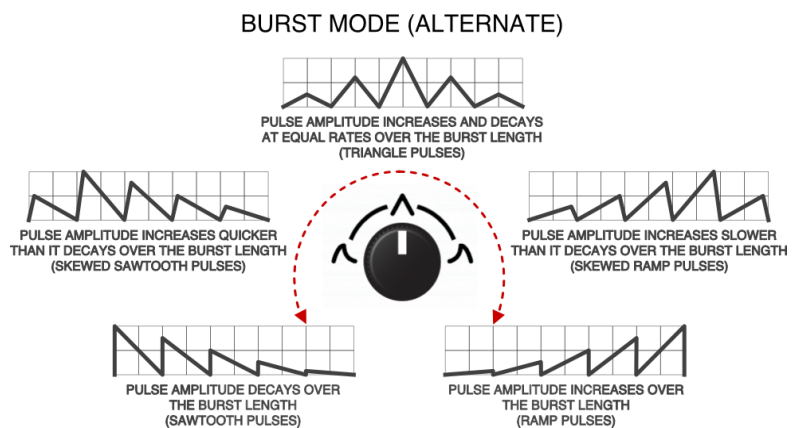

NOTE: To toggle between STANDARD and ALTERNATE operation, long-press (>1 sec) the channel’s **MODE/DESTINATION [6]** button when in BURST Mode. The button will pulse when the ALTERNATE operation is enabled.

[4] LED: Each pulse's intensity and the rate at which they fire can be monitored using this LED. The LED is **green**, indicating that the pulses are positive voltage, and the intensity of the LED indicates the absolute voltage of each pulse (higher voltage = brighter LED).

[5] LINK button: A burst can be retriggered in various ways using the **LINK** button **[5]** to connect it to the previous channel's EOR or EOF trigger.

[6] MODE button: When in BURST Mode, long-press (>1 sec) this button to toggle between Alternate and Standard BURST modes (as described above).

[A] TRIG input: You can configure Burst mode to behave one of two ways when it receives a signal on the channel's TRIG input jack. Either it can reset the phase of the pulses (without retriggering the Burst envelope), or it can reset the burst envelope itself.

You can make this selection globally, as described in [System Mode](#). Specifically:

- Burst Retrigger = OFF

When Burst Retrigger is off (factory default), the entire Burst envelope must complete before it can be retriggered. This option creates the cleanest pulses, and is often the best mode for using Burst Mode as a CV source.

When Burst Retrigger is OFF, the **RISE** button is **blue** in the System Mode menu.

- Burst Retrigger = ON

When Burst Retrigger is ON, then a high voltage received at a Burst channel's TRIG jack re-triggers the burst envelope, regardless of whether it has completed a previously triggered burst. The phase of the bursts is only reset when the burst envelope completes, even with a retrigger. This setting is particularly useful if you want to use BURST mode as an oscillator and envelope (sending pitch to a CV input that's assigned to RISE, and a gate/trigger to the TRIG input). The relative attack/decay times are controlled by the SHAPE knob (along with the oscillator's waveshape — which switches from Square-to-Sine-to-Square in STANDARD Burst Mode, or Saw-to-Tri-to-Ramp in ALTERNATE Burst Mode).

When Burst Retrigger is ON, the **RISE** button is **green** in the System Mode menu.

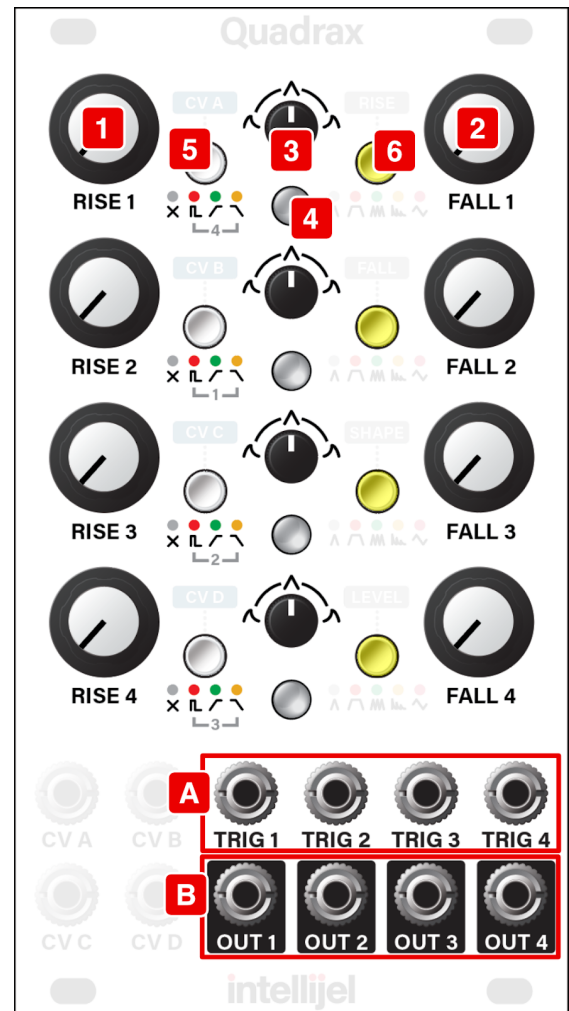

LFO MODE - IN DETAIL

Repeatedly press the **MODE** button [6] to cycle through the various channel modes, stopping when the button turns **magenta** (indicating LFO mode). When set to LFO mode, a channel becomes a bipolar LFO, which appears at the channel's corresponding **OUT** [B] jack.

The channel's **TRIG** input [A] can be used as a clock input for beat-synchronized LFOs, or it can be left unpatched for free-running LFOs. The LFO will phase-lock to a clock signal sent into the **TRIG** input — using the first clock pulse to set the “start” of the LFO, which will remain locked to that clock, even when changing the LFO's Clock Division (set by the RISE/RATE [1] knob).

In LFO mode, Quadrax's controls take on different functions depending on whether you're using the **STANDARD** or **ALTERNATE** LFO. To toggle between **STANDARD** and **ALTERNATE** operation, long-press (>1 sec) the channel's **MODE/DESTINATION** [2] button when in LFO Mode. The button will pulse when the **ALTERNATE** operation is enabled.

LFO Mode (STANDARD)

In **STANDARD** operation, Quadrax's panel works as follows:

[1] RISE (RATE) knob: In **STANDARD** LFO mode, the RISE knob functions as a **RATE** knob. It's used to set the LFO rate (or a division/multiplication of any clock present at the channel's **TRIG** input).

If the LFO is free-running (**TRIG** input unpatched), then rotating the **RATE/RISE** knob clockwise increases the LFO rate from 0.05 Hz (20 s) when fully counterclockwise to around 3.3 kHz (0.30 ms) when fully clockwise. Using **CV** extends the range even further.

If the LFO is beat-synchronized (clock sent to **TRIG** input), then rotating the **RATE/RISE** knob changes the multiplication/division of the incoming clock. At the noon position (straight up), the knob sets the LFO rate equal to the incoming clock rate. Rotating the knob counterclockwise divides the clock, achieving a rate 1/64 of the clock rate when fully counterclockwise. Rotating the knob clockwise multiplies the clock rate, achieving a rate 64 times faster than the incoming clock when fully clockwise.

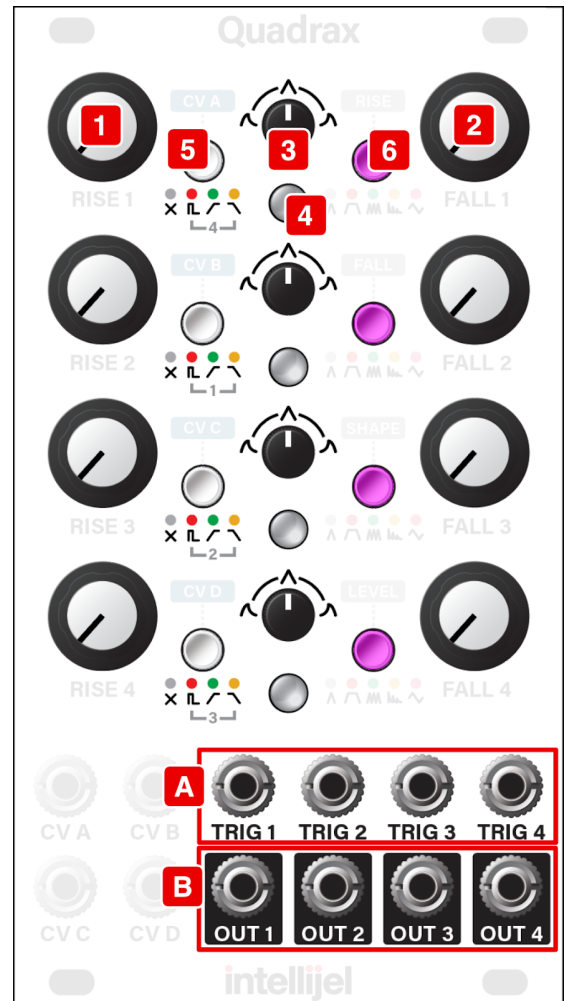

[2] FALL (MORPH) knob: In STANDARD LFO mode, the FALL knob becomes the MORPH knob. It's used to create numerous interesting and morphable variations on the basic waveform set by the central SHAPE knob. These variations are detailed in the [Standard LFO Waveshapes and Morphing](#) section, later in this manual).

[3] SHAPE knob: In STANDARD LFO mode, this knob sweeps through variants of five basic LFO waveshapes (detailed in the [Standard LFO Waveshapes and Morphing](#) section, later in this manual).

[4] LED: The LFO's intensity, polarity and rate can be monitored using this LED. A **green** LED indicates the LFO is outputting a positive voltage and a **red** LED indicates a negative voltage.

[5] LINK button: An LFO can be retriggered in various ways using this button to connect it to the previous channel's EOR or EOF trigger.

If you set a channel to LFO mode, and link it to the previous channel, then the LFO is reset by the previous channel's TRIG input, EOR or EOF.

For example, assume Channel 1 is set to AD mode, and Channel 2 is set to LFO Mode and is linked to Channel 1's EOR (End of Rise). In this scenario, Channel 2's LFO will reset every time it gets an EOR from Channel 1's envelope.

For more on the various link options, see [Channel Link Options](#), earlier in this manual.

Additionally, if you assign multiple channels to LFO Mode and link them, you can trigger multiple beat-synchronized LFOs with a single clock input, as shown in [Multiple Beat Synchronized LFOs](#), below.

[6] MODE button: When in LFO Mode, long-press (>1 sec) this button to toggle between [Standard LFO Mode](#) and [Alternate \(LFV\) Mode](#).

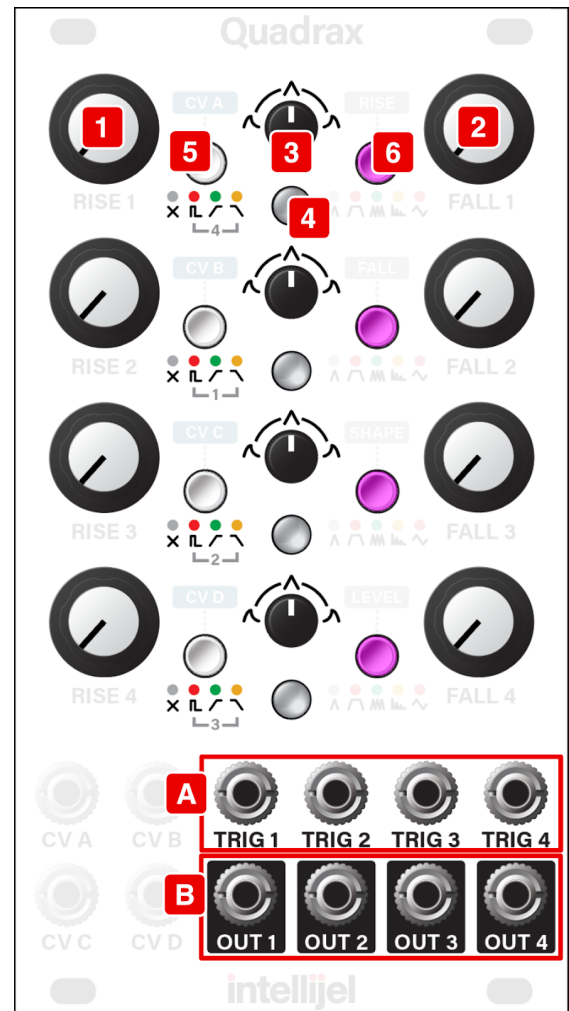

Multiple Beat Synchronized LFOs

Here's an example of how you can beat-synchronize multiple LFOs using a single **TRIG** input:

1. Set Channels 1 and 2 to LFO mode by pressing each channel's **MODE** button [6] until it's **magenta**.
2. Link Channel 2's Trigger to Channel 1's by pressing Channel 2's **LINK** button [5] until it turns **red**.
3. Patch a clock into **TRIG 1**.
4. Use Channel 1's **RISE (RATE)** knob [1] to set the LFO 1 rate to some multiplication or division of the incoming TRIG 1 clock.
5. Use Channel 2's **RISE (RATE)** knob [1] to set the LFO 2 rate to some other multiplication or division of the same incoming clock.
6. For each channel, use the **SHAPE** knob [3] and **FALL (MORPH)** knob [2] to set its LFO waveshape (as discussed further in the next section).

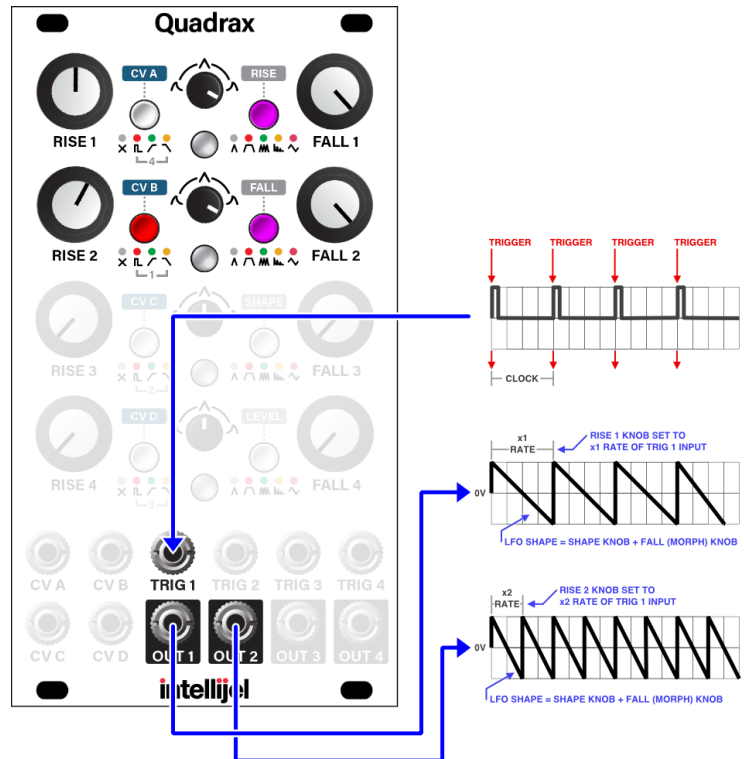

The chained LFOs are all beat synchronized and phase-locked.

You can use Quadrax to create up to 4 channels of clock-synchronized, phase-locked LFOs by connecting the clock source to the **TRIG 1** input and then putting channels 2-4 in their **red** TRIG modes.

Resetting Phase Sync of all Linked LFOs

As described above, only the first LFO in a chain requires a clock on its **TRIG** input — all the subsequent LFOs will synchronize to this same clock at whatever clock rate division/multiplication you set with the **RISE (RATE)** knob [1].

However, if you patch a trigger signal into one of the linked LFO's unused **TRIG** inputs, it also acts as a **RESET** for all the previous channels in the chain — forcing those LFOs to reset to their 'starting' phase on the next clock pulse. For example, if you have all four LFOs synced to LFO1, and you patch a reset into TRIG 4, it will reset LFOs 1-4. But if you patch it into TRIG 2, it will reset only LFOs 1 & 2.

This is particularly useful if your chained LFOs have different clock divisions/multiplications, and you want to resync some (or all) to their beginning phase (such as after a certain number of bars or beats).

STANDARD LFO Waveshapes and Morphing

The following chart shows how the FALL (MORPH) knob [2] and the SHAPE knob [3] work together to create numerous LFO wave shapes. All shapes are continuously variable, and the examples shown here are merely snapshots.

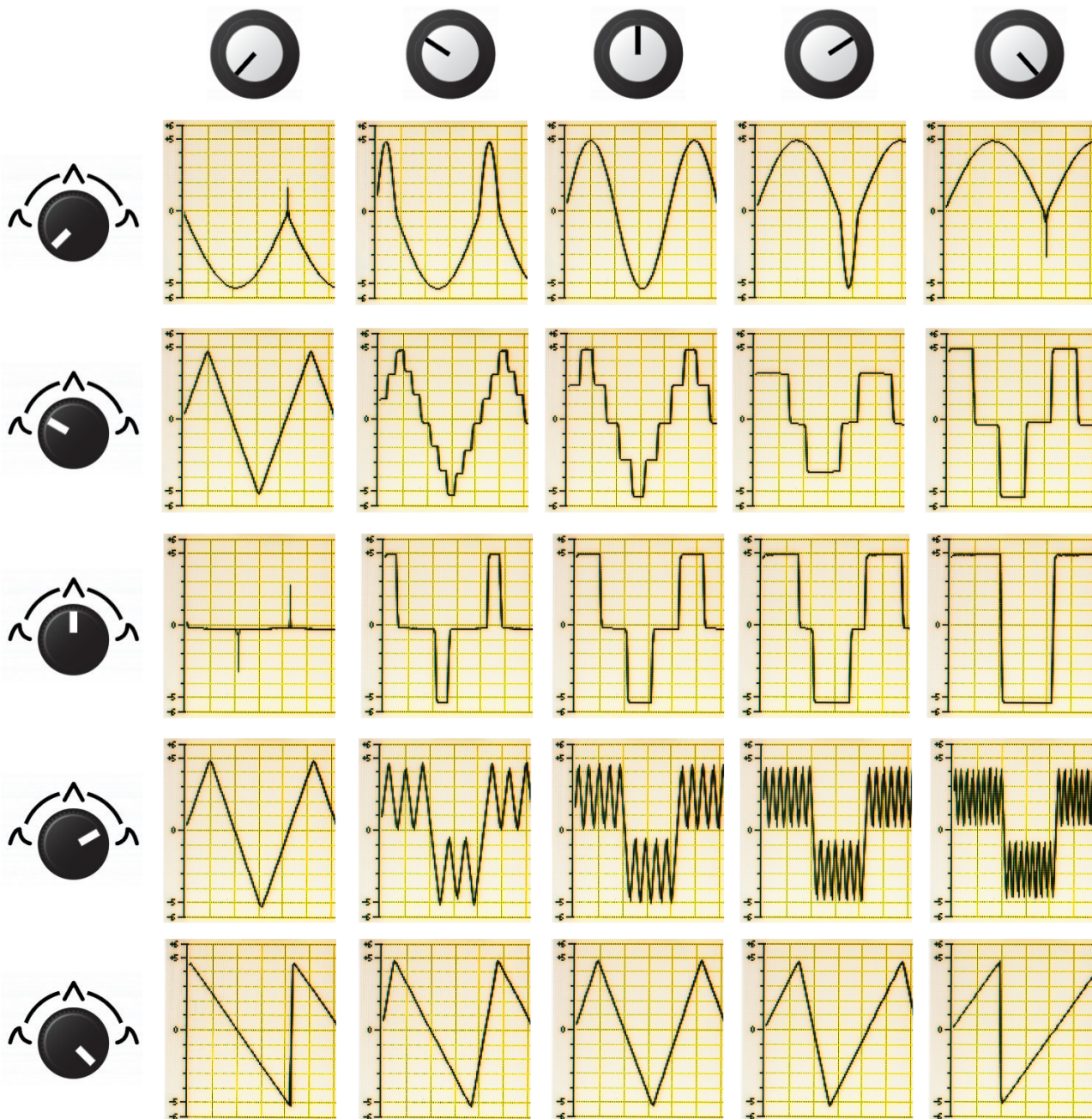

LFO Mode (ALTERNATE)

In ALTERNATE operation (accessed by long-pressing (>1 sec) the channel's **MODE/DESTINATION [6]** button when in LFO Mode), Quadrax's LFO becomes a *Low Frequency Vacillator* (LFV).

In this mode, the oscillations are not repeatable, but chaotic — where each cycle targets a different voltage level (positive or negative), resulting in a staggering, “vacillating” modulation source.

The rate of change is set by the RISE knob. The amount of allowable random variance is set by the FALL knob, and the SHAPE knob slews the changes for a smoother modulation.

When functioning as a Low Frequency Vacillator, Quadrax's controls work as follows:

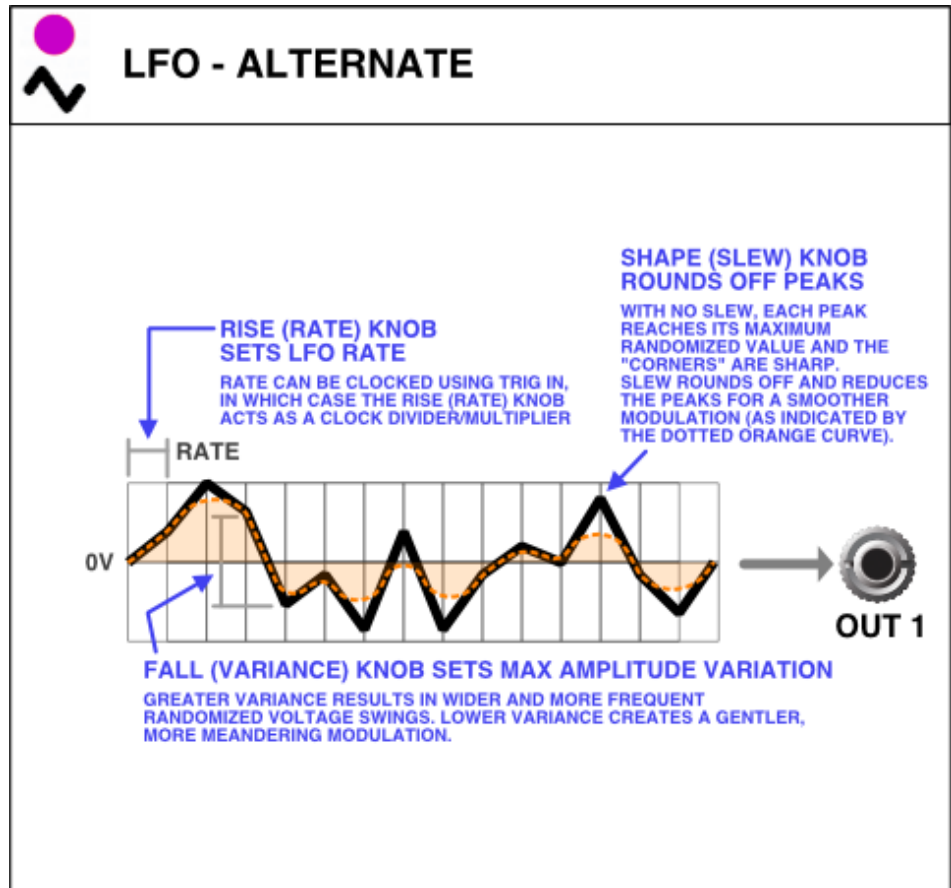

[1] RISE (RATE) knob:

In ALTERNATE LFO mode, the RISE knob functions as a RATE knob. It's used to set the vacillation rate (or a division/multiplication of any clock present at the channel's TRIG input).

If the LFV is free-running (TRIG input unpatched), then rotating the RISE (RATE) knob clockwise increases the vacillation rate from 0.05 Hz (20 s) when fully counterclockwise to around 3.3 kHz (0.30 ms) when fully clockwise. Using CV extends the range even further.

If the LFV is beat-synchronized (clock sent to TRIG input), then rotating the RISE (RATE) knob changes the multiplication/division of the incoming clock. At the noon position (straight up), the knob sets the vacillation rate equal to the incoming clock rate. Rotating the knob counterclockwise divides the clock, achieving a rate 1/64 of the clock rate when fully counterclockwise. Rotating the knob clockwise multiplies the clock rate, achieving a rate 64 times faster than the incoming clock when fully clockwise.

[2] FALL (VARIANCE) knob: In ALTERNATE LFO mode, the FALL knob becomes the VARIANCE knob. It's used to set the extent to which the voltage target for each cycle changes from the previous cycle. High variance (clockwise rotation) creates a fairly random vacillation centered

around 0V. Low variance (counterclockwise rotation) creates a more meandering ‘drunken walk’ through the voltage range.

[3] SHAPE (SLEW) knob: In ALTERNATE LFO mode, this knob slews the directional changes, enabling you to create smoother modulations. When fully counterclockwise, the sharp peaks of each directional change are unaffected. The more clockwise you rotate the SHAPE (SLEW) knob, the more you’ll round off these peaks (reducing both their amplitude and sharpness), which is ideal for creating slowly changing or evolving modulations.

[4] LED: The LFV’s intensity, polarity and rate can be monitored using this LED. A **green** LED indicates the LFO is outputting a positive voltage and a **red** LED indicates a negative voltage.

[5] LINK button: An LFV can be retrigged in various ways using this button to connect it to the previous channel’s EOR or EOF trigger.

If you set a channel to ALTERNATE LFO (LFV) mode and link it to the previous channel, then the LFV is reset by the previous channel’s TRIG input, EOR or EOF.

For example, assume Channel 1 is set to AD mode, and Channel 2 is set to LFV Mode and is linked to Channel 1’s EOR (End of Rise). In this scenario, Channel 2’s LFV will reset every time it gets an EOR from Channel 1’s envelope.

[6] MODE button: When in LFO Mode, long-press (>1 sec) this button to toggle between [Standard LFO Mode](#) and [Alternate \(LFV\) Mode](#).

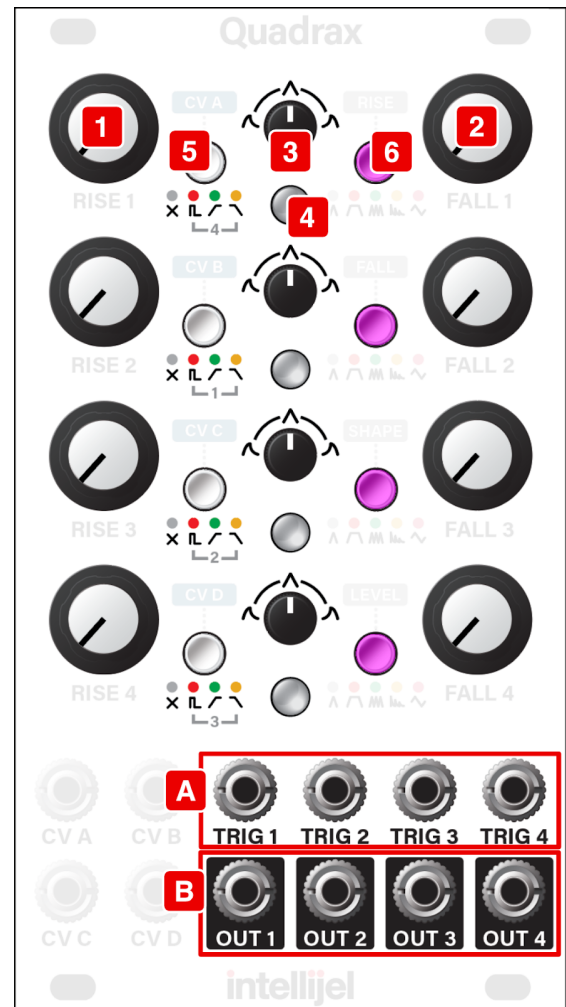

MAKING CV ASSIGNMENTS

Quadrax's **LINK** and **MODE** buttons have a dual purpose, which is to assign each of the module's four CV inputs to one or more destinations, and to attenuvert them as needed. CV assignment functions are written *above* the buttons.

CV assignments are made in Quadrax's CV Assignment mode, which enables access to a fully programmable CV matrix, with which you can freely assign any or all of the four CV inputs to control any or all of four possible destinations for any or all channels.

NOTE: Quadrax's CV inputs track 1 v/oct, so (for STANDARD LFO and BURST modes), it's possible to use Quadrax as an oscillator by sending pitch CV to a CV input, and assigning it to control the RISE function).

Enter/Exit CV Assignment Mode

Each of Quadrax's four channels has its own CV assignment mode. To enter it:

1. Long-press (>1 sec) the LINK/CV button for the channel to which you want to assign CV control.

For example, to assign CV inputs to Channel 1, long-press the top LINK/CV button. To assign CV inputs to Channel 2, long-press the LINK/CV button in the second row, etc.

The active channel's CV button flashes **magenta** to indicate Quadrax is in CV assignment mode, and that all CV input/output assignments will be made on that channel.

2. To make CV assignments on a different channel, long-press the LINK/CV button corresponding to another desired channel.

That button flashes **magenta** to indicate you are now assigning CVs to the channel on this row.

3. To exit CV assignment mode, long-press (>1 sec) whichever LINK/CV button is currently flashing **magenta**.

When in CV Assignment mode, you can freely assign any of the four available CV inputs to control any or all of four destination parameters on each of the four channels using Quadrax's CV Matrix, described below.

Programming the CV Matrix

For each channel, you can assign any or all of the CV inputs to any or all modulation destinations. Furthermore, you can attenuvert the amount of CV used to modulate each destination. In theory, you could route each of the four CV inputs to 16 destinations simultaneously (4 destinations per channel) — each attenuverted as needed.

The possible destinations (per channel) are (from top button to bottom):

- Rise time
- Fall time
- Shape
- Level (envelope/LFO amplitude)

To program the CV Matrix:

1. Enter CV assignment mode by long-pressing the LINK/CV button next to the channel to which you'd like to apply CV control.

For example, if you want to assign CV control to Channel 1, long-press Channel 1's LINK/CV button.

The active channel (to which you will make CV assignments) is indicated by a flashing **magenta** CV button.

2. Press the CV button corresponding to the CV input you wish to assign (as indicated by the text *above* the button).

For example, if you want CV B to modulate some parameter, press the **CV B** button. It will glow **blue** to indicate that it's active.

3. Press the MODE/DESTINATION button corresponding to the parameter you wish to modulate: RISE, FALL, SHAPE, or LEVEL.
4. Repeatedly press the MODE/DESTINATION button to change the amount by which the input CV affects the parameter.

There are four levels of attenuation, indicated by the brightness of the button. A fully lit button indicates 100% of the CV input value is used to modulate the parameter. The button grows

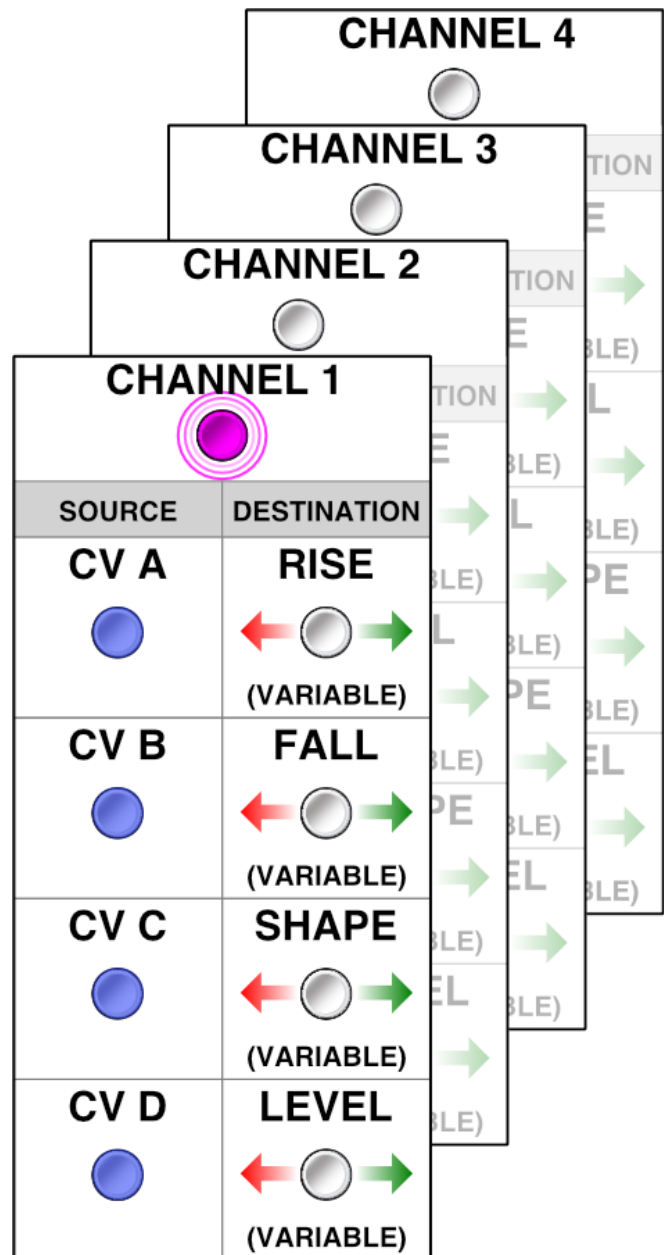

progressively dimmer as more attenuation is applied (meaning CV has less effect on the destination). To disable CV control of a destination, repeatedly press the destination button until the button light extinguishes.

- To invert the effect of the CV input, long-press (>1 sec) the MODE/DESTINATION button.

The destination button glows **red** when the CV input is inverted, and **green** when it is not. The same four levels of attenuation are available for inverted CV, giving you 8 possible attenuverted levels, plus “off” (no CV control over the parameter).

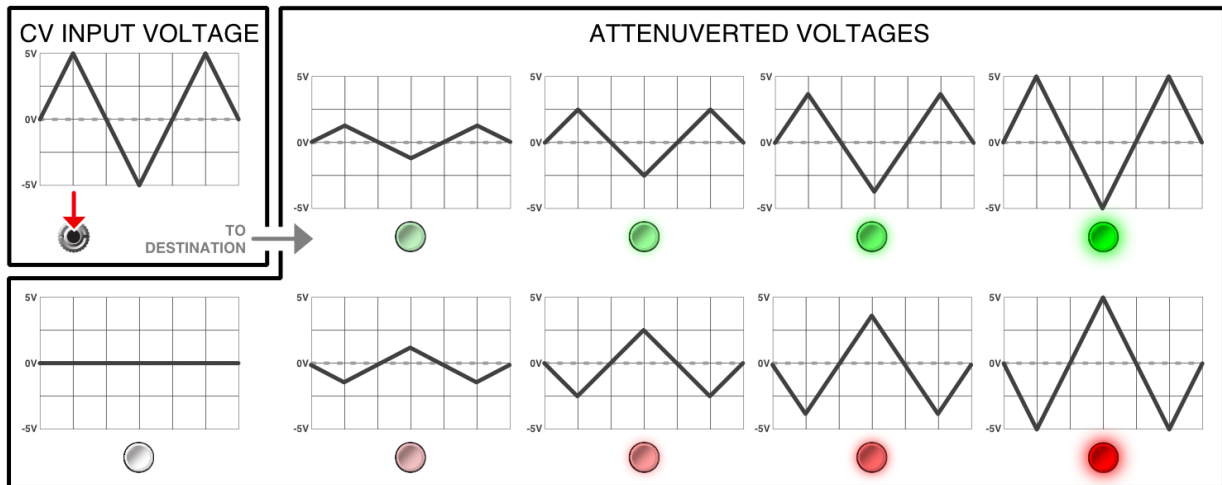

- Repeat steps 3-5 to assign the CV input to more destinations (if you wish) and to attenuvert them accordingly.
- If you wish to assign another CV input, press the **CV** button corresponding to the CV input you next wish to configure, and follow steps 3-5 to assign its modulation destination(s).
- If you wish to make CV assignments on a different channel, long-press the LINK/CV button corresponding to the channel you next wish to configure (the active channel will flash **magenta**), and follow steps 2-7 to configure its CV inputs.

Here is a recap of what the various button colors indicate in CV Assignment mode:

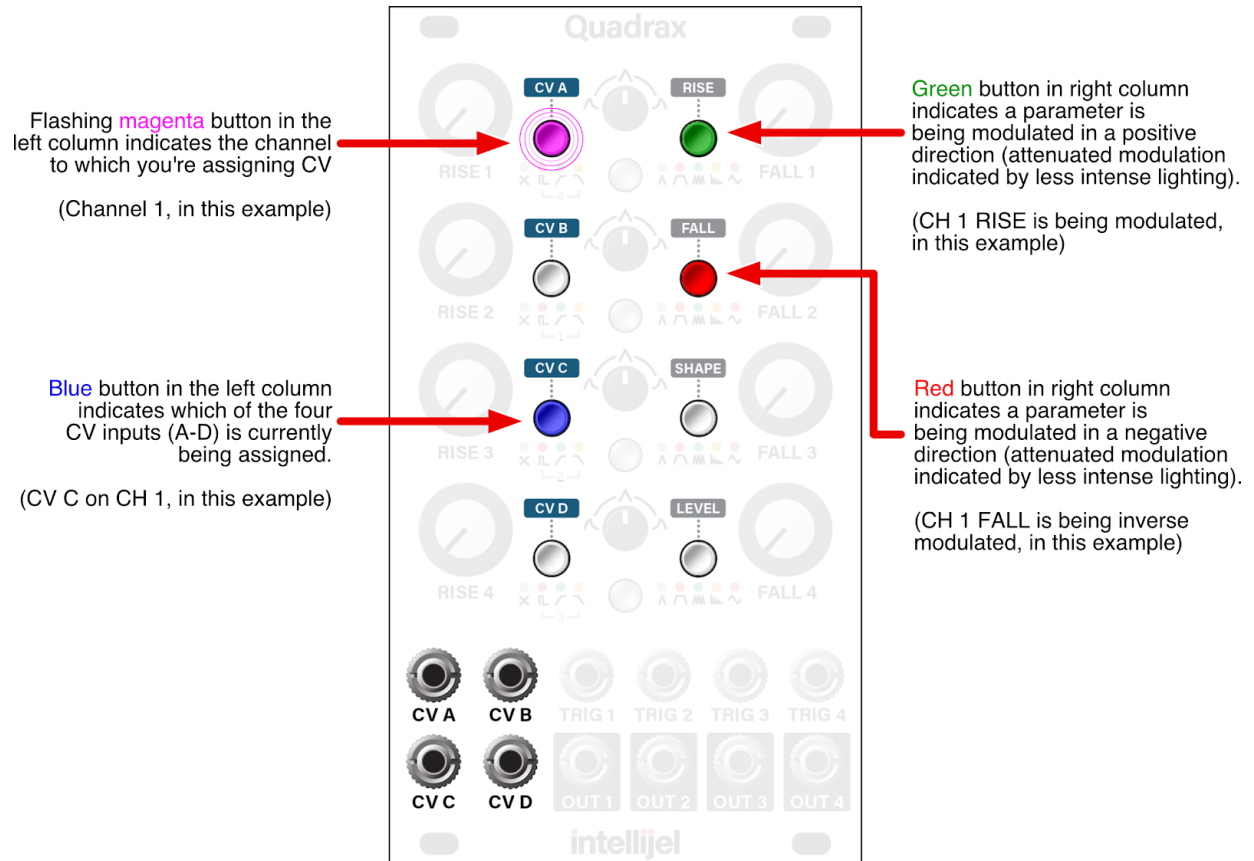

- When you're done making CV assignments for all channels, long-press the LINK/CV button that's currently flashing **magenta**.

Quadrax returns to standard operating mode.

CLEARING CV ASSIGNMENTS

You can clear individual CV assignments (as discussed, above, in [Programming the CV Matrix](#)); all CV assignments for a single channel; or all CV assignments for all channels. Specifically:

To clear all CV assignments on a single channel:

1. Make sure Quadrax is in CV Assignment mode (as discussed in [Enter/Exit CV Assignment Mode](#), earlier in this manual).
2. For the channel whose CV assignments you wish to clear, long-press (>1 second) the channel's LINK/CV and MODE/DESTINATION buttons simultaneously.

The channel's LINK/CV button will flash blue along with all four DESTINATION buttons, and all CV assignments will be cleared on that channel.

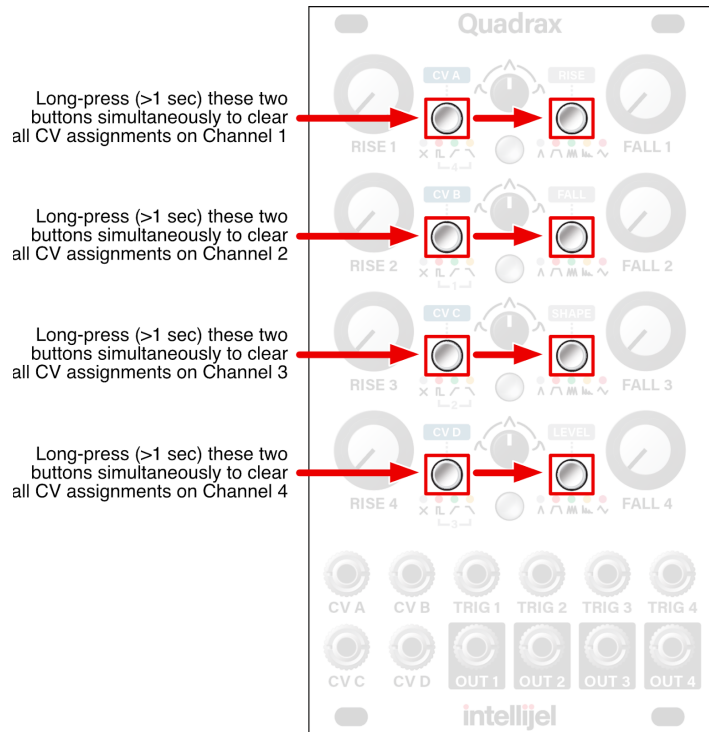

To clear all CV assignments on all channels:

1. Make sure Quadrax is in CV Assignment mode (as discussed in [Enter/Exit CV Assignment Mode](#), earlier in this manual).
2. Long-press (>1 second) the **CV A** (top left) and the **LEVEL** (bottom-right) buttons simultaneously.

All eight buttons will flash blue, indicating that all CV assignments have been cleared on all four channels.

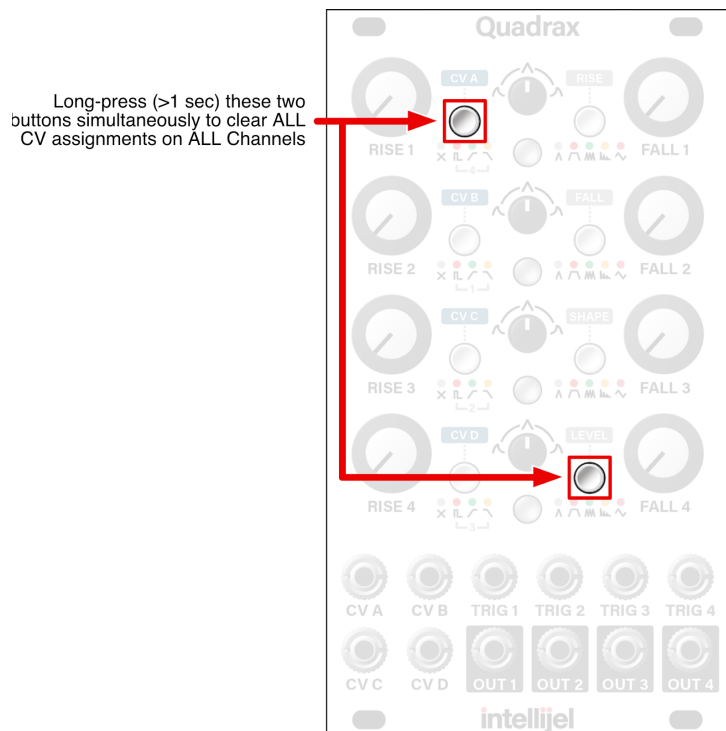

USING THE OPTIONAL QX MODULE

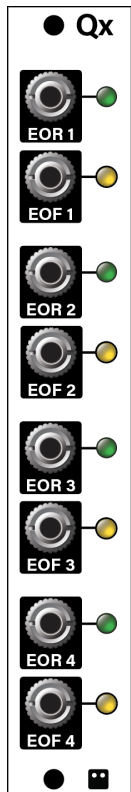

The Qx expander adds an EOR (**End Of Rise**) and an EOF (**End Of Fall**) output to each of Quadrax's four channels, enabling Quadrax's envelopes, cycles, bursts and LFOs to trigger external modules.

The definition of EOR and EOF varies depending on which mode is assigned to the corresponding Quadrax channel.

NOTE: You can also use an Intellijel Gx module in place of a Qx. It functions identically, only the Gx has generic output labels (1-8), rather than the Quadrax-specific EOR/EOF output labels.

The following sections discuss exactly what triggers the Qx module's EOR and EOF outputs for each of Quadrax's five modes.

EOR/EOF for AD Mode

If a channel is set to AD mode, then the EOR and EOF outputs perform as follows:

- **EOR:** End of Rise: Goes high when the Attack portion of the envelope reaches its maximum value, and stays high until the envelope completes its decay phase.
- **EOF:** End of Fall: Goes low (0V) when the Attack portion of the envelope reaches its maximum value, and stays low until the envelope completes its decay cycle, at which point the EOF goes high.

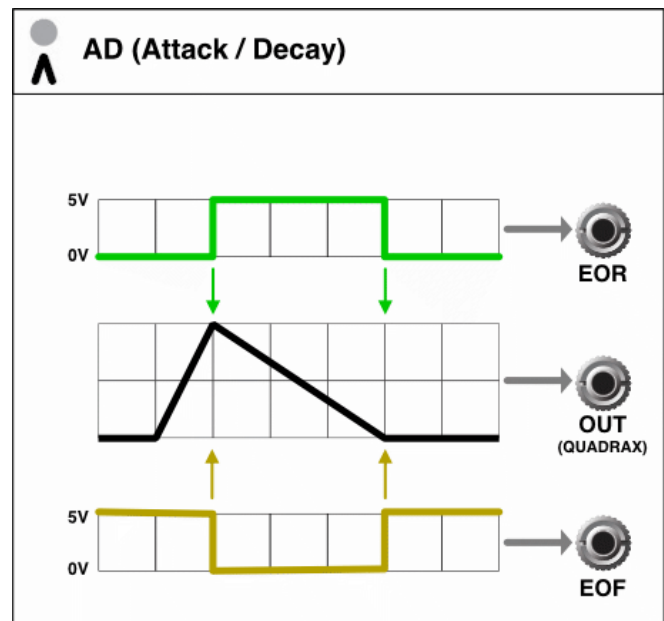

EOR/EOF for AHR Mode

If a channel is set to AHR mode, then the EOR and EOF outputs perform as follows:

- **EOR**: End of Rise: Goes high when the Attack portion of the envelope reaches its maximum value, and stays high until the end of the release phase.
- **EOF**: End of Fall: Goes low (0V) at the start of the Release phase of the envelope (immediately after completing the Hold phase), and stays low until the envelope completes its release cycle, at which point the EOF goes high.

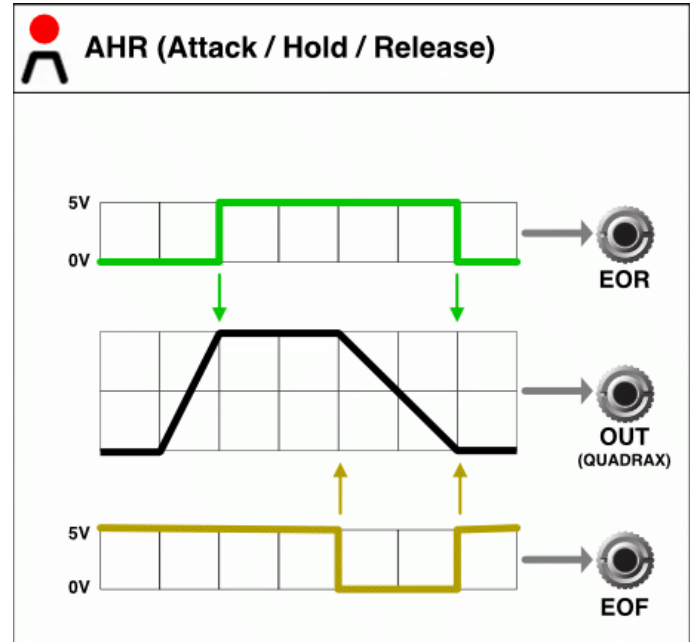

EOR/EOF for CYCLE Mode

If a channel is set to CYCLE mode, then the EOR and EOF outputs perform as follows:

- **EOR**: End of Rise: Goes high when the Attack half of the cycle reaches its maximum value, and stays high until the cycle completes its decay phase, at which point the EOR goes low (0V).
- **EOF**: End of Fall: Goes low (0V) when the Attack half of the cycle reaches its maximum value, and stays low until the cycle completes its decay phase, at which point the EOF goes high.

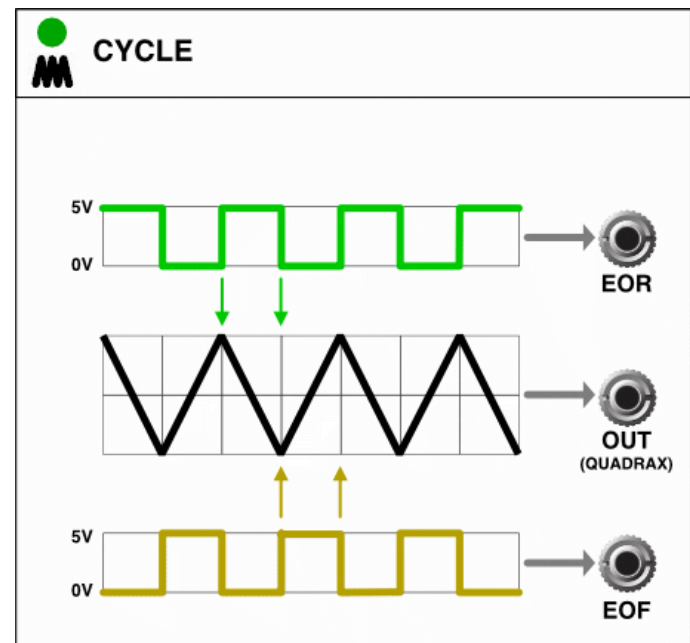

EOR/EOF for BURST Mode

If a channel is set to BURST mode, then the EOR and EOF outputs perform as follows:

- **EOR:** Goes high at the beginning of each individual pulse within a burst, and stays high for the first half of the pulse phase. This lets you trigger events in time with each individual pulse.
- **EOF:** Stays at 0V for the entire length of the pulse burst (set with the FALL knob on Quadrax), then goes high at the end of the overall burst, where it stays until the next burst is triggered. This lets you trigger events in time with the start and/or stop of the burst length.

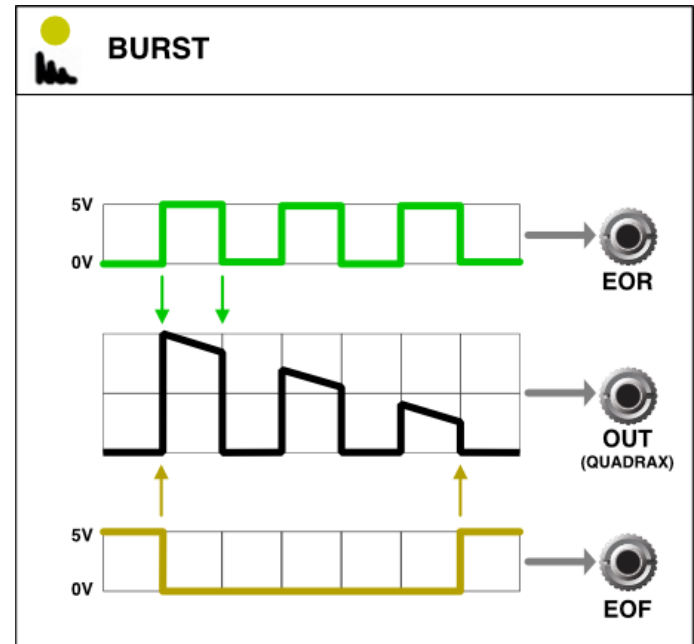

EOR/EOF for LFO Mode

If a channel is set to LFO mode, then the EOR and EOF outputs perform differently depending on whether you're using the STANDARD LFO or the ALTERNATE LFO:

For the **STANDARD** LFO:

- **EOR**: The EOR output goes high half-way through the cycle, and remains high until dropping to 0V when the cycle resets.
- **EOF**: The EOF output is high for the first half of an LFO cycle, and low (0V) for the second half.

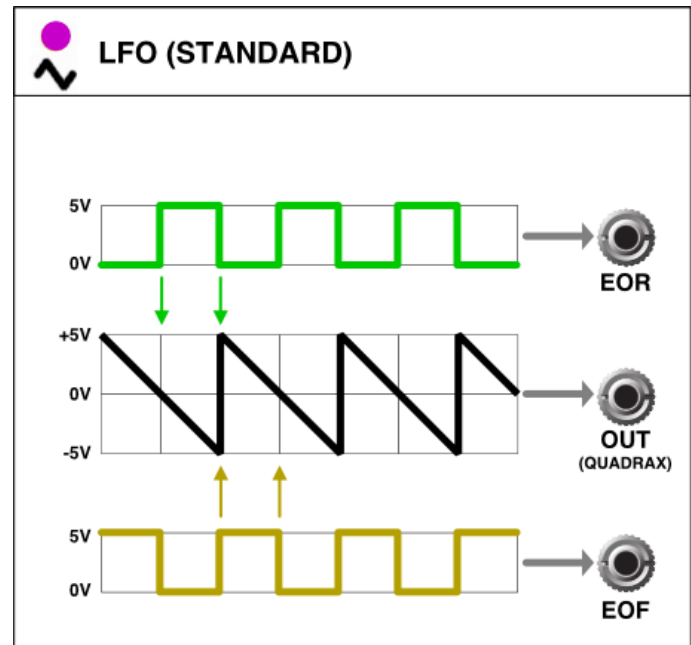

For the **ALTERNATE** LFO:

- **EOR**: The EOR output is high whenever the voltage moves in a negative direction.
- **EOF**: The EOF output is high whenever the voltage moves in a positive direction.

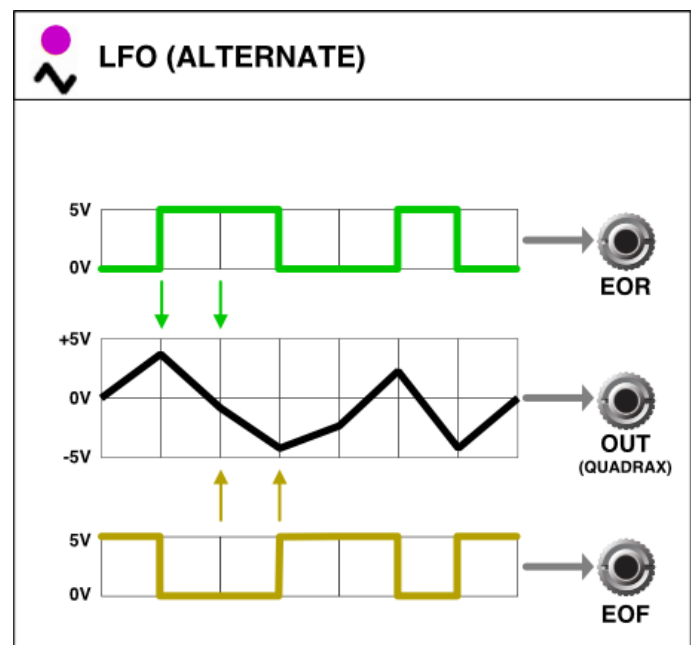

UTILITY MODE

Utility Mode is a special mode, which enables you to manually triggering each channel, and to set the desired maximum output voltage for each channel.

To enter/exit Utility Mode:

1. Hold down the **RISE** and **LEVEL** buttons for 1 second to toggle Utility Mode on/off.

In Utility Mode, the left column of buttons are all **pink**, and the right column of buttons may be varying intensities of either **orange** or **teal**.

In general, when in Utility Mode:

- Press any of the left buttons to manually trigger the corresponding channel (honoring the [Channel Link options](#) set prior to entering Utility mode).
- Long-press (>1 sec) any of the right buttons to toggle the channel's maximum output voltage between 10V and 5V. This sets the maximum voltage output of **AD**, **AHR**, **CYCLE** and **BURST** modes. When set to 10V, the button is **teal**. When set to 5V, the button is **orange**.

NOTE: The output of a channel assigned to LFO Mode is always a maximum of ±5V (bipolar), so you cannot put an LFO channel into 10V mode (meaning the button will always be orange).

- Press (<1 sec) any of the right buttons to attenuate the output voltage of the corresponding channel. Each press attenuates the output voltage by 20%, then wraps back to full voltage on the fifth press. This makes Quadrax particularly adept at modulating other modules that lack built-in attenuators. Specifically:
 - If the channel is set to 5V mode (**orange** button), then pressing the button repeatedly will cycle from 5V > 4V > 3V > 2V > 1V > 5V, etc.
 - If the channel is set to 10V mode (**teal** button), then pressing the button repeatedly will cycle from 10V > 8V > 6V > 4V > 2V > 10V, etc.

Long-press a button to toggle between 10V (TEAL) and 5V (ORANGE) maximum output.

Press a PINK button to manually trigger the corresponding channel

Press to attenuate output voltage (20% attenuation per press), indicated by reduced intensity

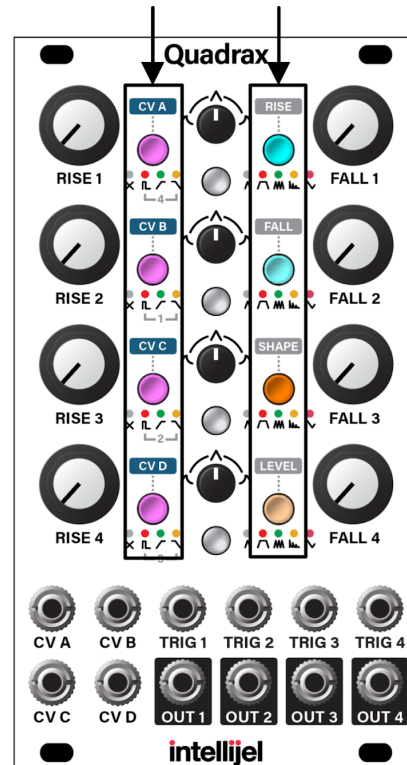

SYSTEM MODE

System Mode is a special boot mode for toggling global module settings on and off.

To enter System Mode:

1. To put Quadrax into System Mode, hold down the **LEVEL** button (Channel 4's **MODE/DESTINATION**) button while you power on the module.

Once in System Mode, you can perform a number of global functions, as discussed in [System Mode Options](#), below.

To exit System Mode:

1. To exit System Mode and save your settings, press the flashing **red** **LEVEL** button.

System Mode Options

Several global options are available in System Mode, as outlined below.

Burst Retriggering Option

1. In System Mode, press the **RISE** button to toggle re-triggering of the **BURST** envelope on/off. See [Burst Mode - In Detail](#) for a detailed description of what this means.

Burst Retrigger OFF: The **RISE** button is **blue** (factory default)

Burst Retrigger ON: The **RISE** button is **green**

Dithering Option

1. In System Mode, long-press the **CV D** button to toggle dithering on and off. Dithering should be turned ON **only** for the handful of first-run modules that use 12-bit DACs. Dithering should be turned OFF for all the modules that use 16-bit DACs.

DITHER ON: The **CV D** button is **pink**.

DITHER OFF: The **CV D** button is **unlit**.

NOTE: There are no sonic differences between a 12-bit module with dithering enabled, and a 16-bit module with dithering disabled. To see which version you own, look for the DAC on the back of the Quadrax module. Those labeled **2624** are 12-bit (and require that dithering be turned ON). Those labeled **2604** are 16-bit (and require that dithering be turned OFF).

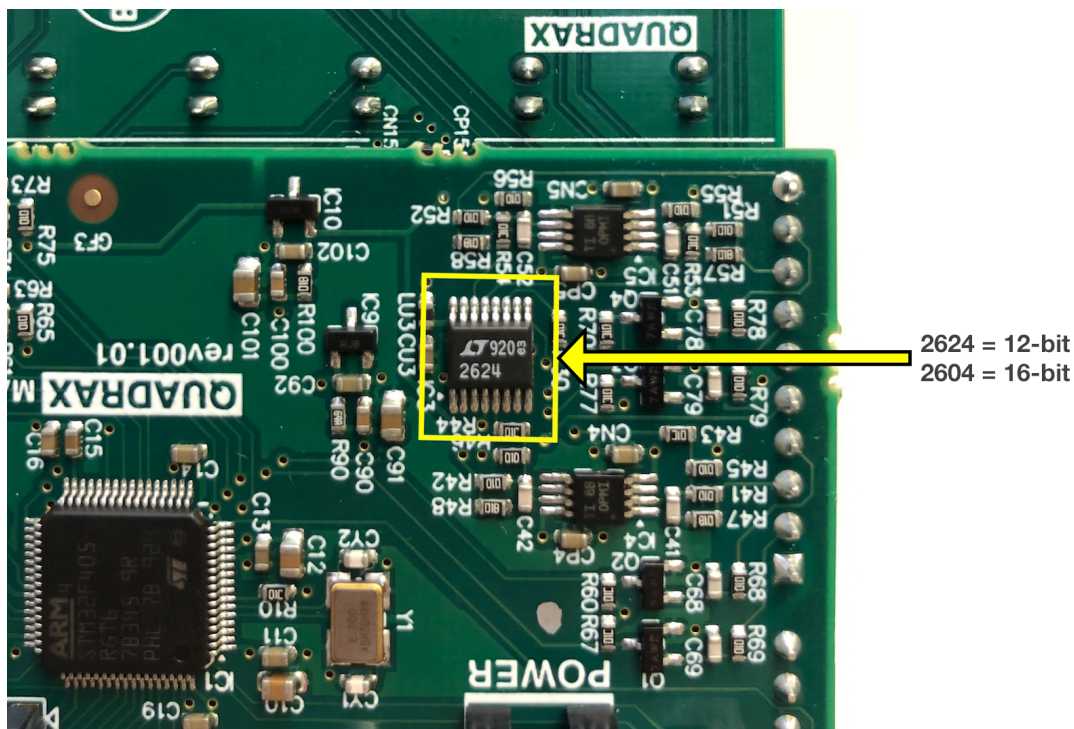

CVD (Color Vision Deficiency) Mode

For those who have difficulty distinguishing between the LED colors in Quadrax' normal mode, there is a special CVD mode which you enable in System Mode. To enable/disable CVD mode:

1. In System Mode, press the **CV A** button to toggle between CVD (**orange**) and standard (**blue**) modes.

When set to CVD mode, modes and features use a different color/flashing scheme than standard mode, as shown below:

2. To exit System Mode and save your settings, press the flashing **LEVEL** button.

Link Options	Standard Mode	CVD Mode
OFF	OFF	OFF
TRIG	RED	DIM BLUE
EOR	GREEN	MED BLUE
EOF	YELLOW	BRIGHT BLUE
IN TRIG	BRIGHT WHITE FLASH	BRIGHT WHITE FLASH

Channel Mode	Standard Mode	CVD Mode
AR	OFF	OFF
AHR	RED	DIM BLUE
AR-CYCLE	GREEN	BRIGHT BLUE
BURST	YELLOW	DIM ORANGE
LFO	PURPLE	ORANGE

Mod Matrix	Standard Mode	CVD Mode
CV INPUT	BLUE	BLUE
CHANNEL	MAGENTA BLINKING	ORANGE BLINKING
OFF	OFF	OFF
POSITIVE	GREEN	BLUE
NEGATIVE	RED	ORANGE

Performance Mode	Standard Mode	CVD Mode
TRIG	PINK	GREY/WHITE
10V	CYAN	BLUE
5V	ORANGE	ORANGE

Reset to Default

1. In System Mode, long-press the **LEVEL** button to reset the module to its default settings.

NOTE: If you have an old 12-bit DAC (as described above), be certain to turn dithering back ON, after resetting your module.



FIRMWARE VERSION DISPLAY

Firmware updates, if available, are contained within the latest **Intellijel Firmware Updater** application, which you can download from the product's page on the Intellijel.com website. The application is available in both Macintosh and Windows formats, and will install firmware into your module over USB. Use the drop-down lists at the top of the application to select the product you wish to update, and the firmware version you want to install. Click the **Instructions** button to read specific instructions for updating your module.

Quadrax's current firmware version is displayed for approximately 2 seconds when you power on the module. It displays the firmware version in binary format using the **1.x.y** format, with the left column displaying the **x** value and the right column displaying the **y** value.

In each column, the top LED is bit 0 and the bottom LED is bit 3.

For example, the illustration on the right indicates firmware version 1.5.2. The Major version (1.x.x) is implied, while the left column (0101) is a "5" and the right column (0010) is a "2":

v1.	5.	2	
	1	0	(bit 0)
	0	1	(bit 1)
	1	0	(bit 2)
	0	0	(bit 3)

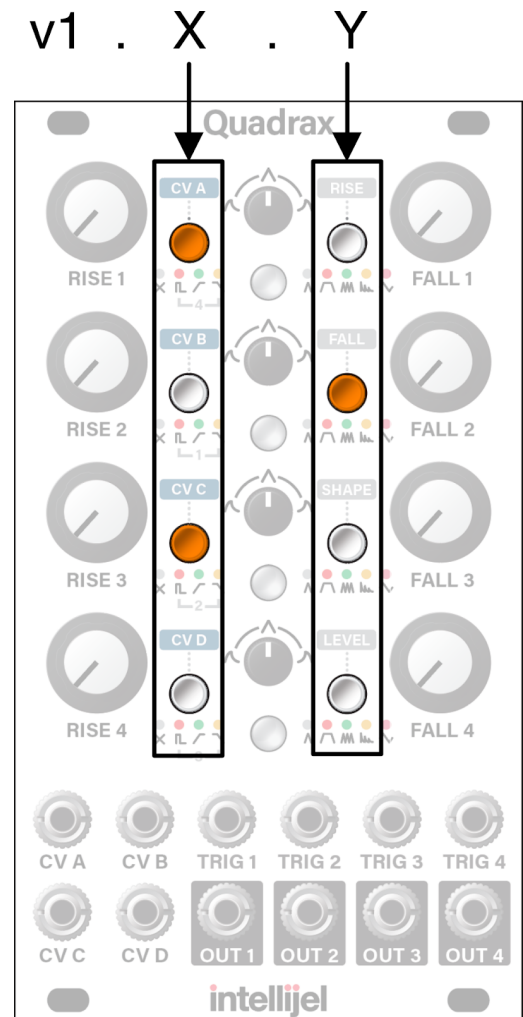

FIRMWARE CHANGE LOG

1.4 (April, 2023)

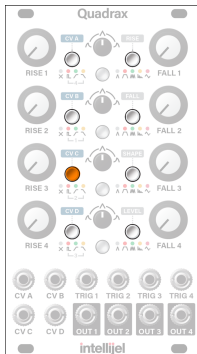

- **NEW** : [CVD Mode](#) — an alternative button coloring scheme for improving Quadrax' usability for those with Color Vision Deficiency.
- **NEW**: in [Utility Mode](#), the sync LEDs now flash with a trigger.

1.3 (September, 2021)

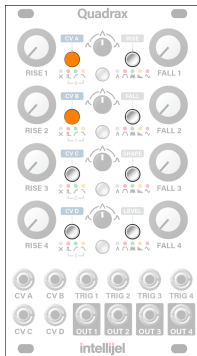

- **NEW**: [Utility Mode](#) for manually triggering each channel, and for setting output voltages for each channel.

Hold down the **RISE** and **LEVEL** buttons for 1 second to toggle Utility Mode on/off. In Utility Mode, the left column of buttons are all **pink**, and the right column of buttons may be varying intensities of either **orange** or **teal**. In general, when in Utility Mode:

- Press any of the left buttons to manually trigger the corresponding channel (honoring the Channel Link options set prior to entering Utility mode).
- Long-press (>1 sec) any of the right buttons to toggle the channel's maximum output voltage between 10V and 5V. This sets the maximum voltage output of **AD**, **AHR**, **CYCLE** and **BURST** modes. When set to 10V, the button is **teal**. When set to 5V, the button is **orange**.
- Press (<1 sec) any of the right buttons to attenuate the output voltage of the corresponding channel. Each press attenuates the output voltage by 20%, then wraps back to full voltage on the fifth press. For example, if the channel is set to 5V mode (orange button), then pressing the button repeatedly will cycle from 5V > 4V > 3V > 2V > 1V > 5V. This makes Quadrax particularly adept at modulating other modules that lack built-in attenuators.
- **CHANGED**: Previously, the 10V/5V output setting was applied globally from the System Mode menu. That option has been removed from the System Menu, since it's now a per-channel option that's configured in Utility Mode. Also, because the 10V/5V option is no longer global, firmware versions are now displayed with orange buttons upon booting.
- **FIXED**: Phase/Clock Sync abnormalities in [LFV Mode](#).

1.2.1 (9 March, 2021)

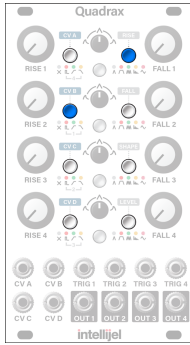

- **MODIFIED:** Reduced size of pot dead zone.
- **FIXED:** Slightly longer minimum attack and decay times. Fixes modulation of some waveform types when at minimum.
- **FIXED:** LFOs not clock syncing in some cases.
- **FIXED:** Channel link is a gate (not a trigger), allowing you to link one AHR to another envelope, and have the hold time respect the gate length of the linked TRIG input.

1.2.0 (19 Nov, 2020)

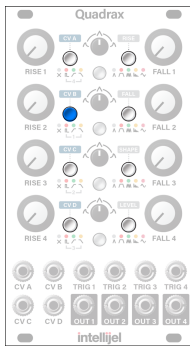

- **NEW:** LFOs are now phase locked to the TRIG input. Linked LFOs are all phase locked to the first LFO's TRIG input. All linked LFOs can be reset by patching a trigger signal into any one of the chained LFO TRIG inputs. This operation is described along with other LFO features in [LFO MODE - IN DETAIL](#).
- **MODIFIED:** Even snappier envelopes. Attack and decay times can now go to virtually zero.
- **MODIFIED:** Remove crossfade at the extreme ends of standard burst mode. Instead the waveform just switches from square to sine and back as you rotate the SHAPE knob.
- **MODIFIED:** Add 5% dead zone at end of pot travel to account for component tolerances.
- **MODIFIED:** Various optimizations, reduced latency.
- **FIXED:** Improved trigger detection.
- **FIXED:** Fix LFO lockup at extreme ends of range.
- **FIXED:** Fix cycle mode getting stuck when rise and fall both set to minimum.
- **FIXED:** Fixed initial phase of one-shot mode square waveformers.
- **FIXED:** Fixed one-shot retrigger.
- **FIXED:** High CPU usage for one-shot mode.
- **FIXED:** High CPU usage for multiple LFOs and dithering enabled.

1.1.3 (3 Mar, 2020)

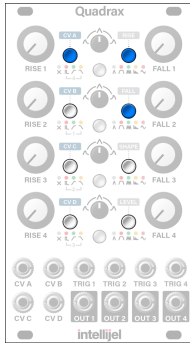

- **FIXED:** Some settings may not have carried over correctly when the firmware was upgraded from 1.0.2 or earlier.

1.1.2 (25 Feb, 2020)

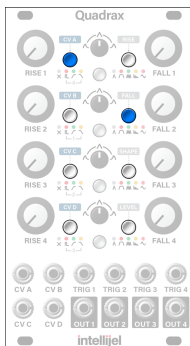

- **NEW:** Long-press the **LEVEL** button when in System Mode to reset the module to its default settings.
- **FIXED:** Edge case where CV assignments were not being applied.

1.1 (6 Feb, 2020)

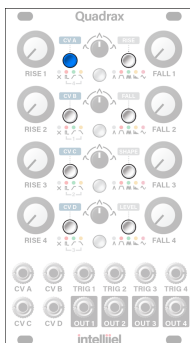

- **NEW:** Expanded and redesigned Burst Mode replaces previous version entirely. Specifically:

The RISE knob now sets the rate of pulse repetition, while the FALL knob sets the overall length of the pulse burst envelope. With the SHAPE knob in the counterclockwise position, individual pulse amplitudes decrease over the entire burst length. With the SHAPE knob in the clockwise position, individual pulse amplitudes rise over the entire burst length. At the noon position, maximum pulse amplitude occurs at the midpoint of the burst envelope. In-between positions skew the envelope (and, thus, the attack and decay times of the burst) accordingly.

Rotating the SHAPE knob morphs the pulse shape from square to sine and back to square as you sweep its arc. Using the new Alternate Mode (discussed below), you can change the pulse shape to a tilting saw shape, that begins as a saw (when the SHAPE knob is fully counterclockwise; tilts into a triangle at the noon position, then further tilts into a ramp wave when fully clockwise.

See [Burst Mode - In Detail](#), earlier in the manual for a complete description of the new Burst Mode.

- **NEW:** Alternate modes

Each Mode now features both STANDARD and ALTERNATE functionality. Specifically:

- [AD](#), [AHR](#), [CYCLE](#) modes: ALTERNATE version features mirrored attack and decay(release) curves. That is, a logarithmic RISE is paired with an exponential FALL (creating a gradual, bell-like curve), while an exponential RISE is paired with a logarithmic fall (creating a sharp, needle-like curve).
- [BURST](#): Instead of using a square/sine pulse shape, the ALTERNATE version uses a tilting Saw shape (that morphs into a triangle at noon, and a ramp when fully clockwise).
- [LFO](#): The ALTERNATE LFO outputs a non-repetitive, vacillating voltage source with control over the cycle-to-cycle variance and the amount it's slewed.

Toggle each Mode's ALTERNATE operation on/off by first selecting the mode you wish to use, then long-pressing (>1 sec) the **MODE/DESTINATION [6]** button. When the ALTERNATE mode is enabled, the button will pulse slightly.

- **NEW:** System Mode for toggling global module settings. See [System Mode](#) to learn how it works.
- **MODIFIED:** More extreme log/expo curves
- **MODIFIED:** 10V is the new default
- **FIXED:** Distorted expo/log curves fixed.

1.0.2 (19 Dec, 2019)

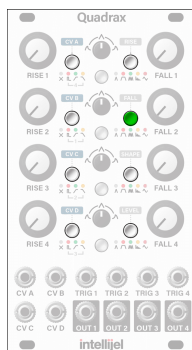

- **FIXED:** Modified dithering algorithm to remove "quantize error noise" discovered when processing certain low frequency signals. Hold SHAPE on boot to toggle dithering. LEDs will all blink Magenta after displaying the version number on boot when dithering enabled.

1.0.1 (Nov, 2019)

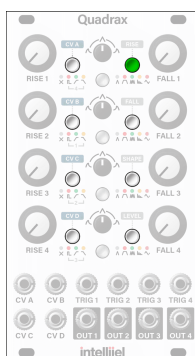

- Initial Release

TECHNICAL SPECIFICATIONS

QUADRAX	
Width	14 hp
Maximum Depth	38 mm
Current Draw	106 mA @ +12V 9 mA @ -12V

Qx EXPANDER	
Width	4 hp
Maximum Depth	22 mm
Current Draw	8 mA @ +12V 0 mA @ -12V