

Tête + Tetrapad

Recordable, Syncable, Multi-Dimensional Performance Touch Controller

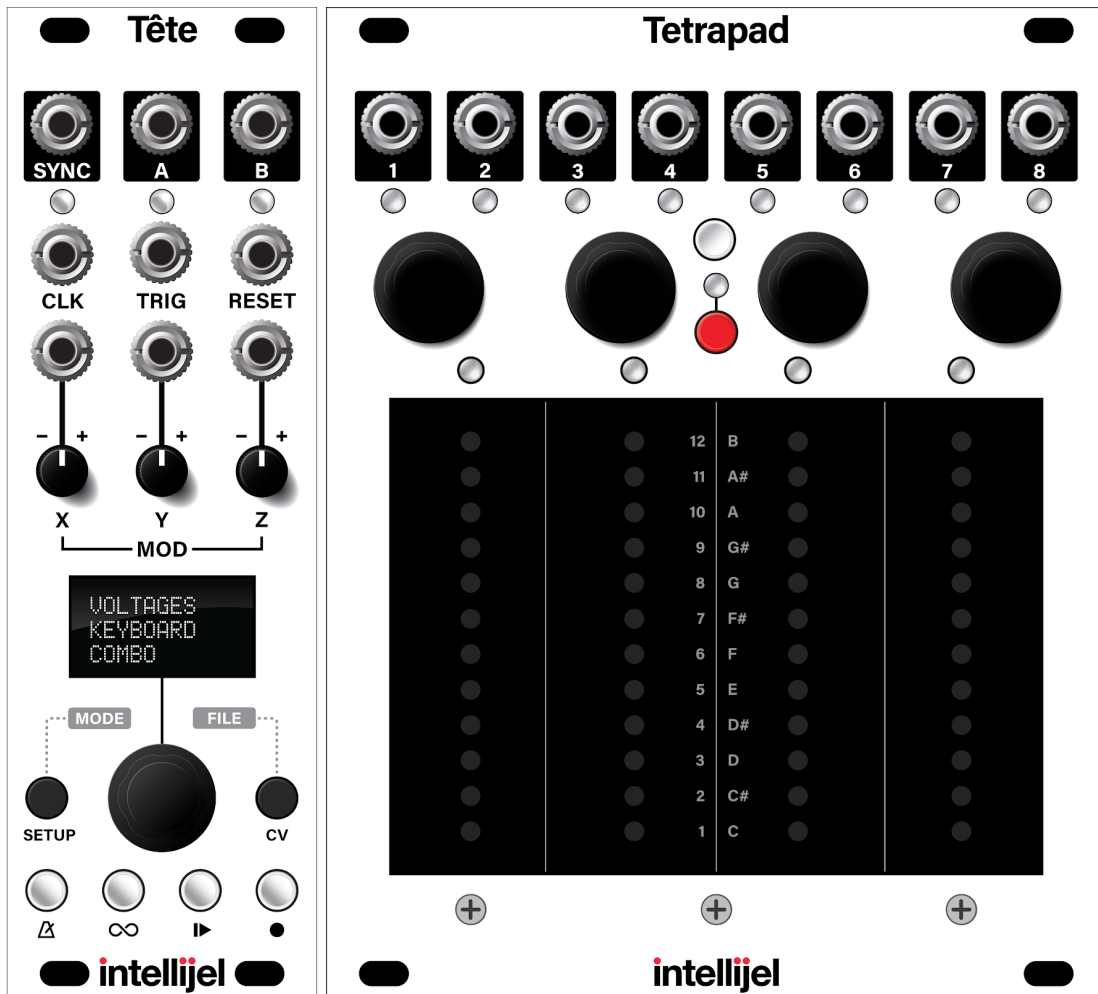

IMPORTANT!

This manual discusses Tête and Tetrapad when the two are used together. Tetrapad, when used without Tête, operates significantly differently and has its own dedicated manual.

TABLE OF CONTENTS

COMPLIANCE	7
PART ONE: INSTALLATION	8
INSTALLATION	9
Installing Your Modules	9
Connecting Tête to Tetrapad	11
Setting Tetrapad's DIP Switches	11
The microSD Card	12
PART TWO: OVERVIEW	13
OVERVIEW	14
TETRAPAD PANEL OVERVIEW	16
Tête PANEL OVERVIEW	19
Outputs	19
Inputs & Attenuverters	20
Controls	25
MODE OVERVIEW	28
PART THREE: COMBO MODE	29
COMBO MODE	30
Entering Combo Mode	32
Assigning a Function to a Pad	32
Main Screen & Menus in Combo Mode	34
Combo Mode: Unipolar Fader	35
Assigning Unipolar Fader Functionality To A Pad	36
Using Unipolar Faders	37

Slew Between Fader Settings	38
Quantizing Fader Values	38
Combo Mode: Bipolar Fader	39
Assigning Bipolar Fader Functionality To A Pad	40
Using Bipolar Faders	41
Slew Between Fader Settings	42
Quantizing Fader Values	42
Combo Mode: Crossfader	43
Assigning Crossfader Functionality To A Pad	44
Selecting a Crossfader Type	45
Using Crossfaders	47
Slew Between Fader Settings	48
Combo Mode: Euclidean	49
Assigning Euclidean Functionality To A Pad	50
Using Euclidean Pads	51
Creating & Rotating Syncopated Patterns	53
Using Euclidean Pads as Simple Drum Pads	54
Slew Between Vertical Output Voltages	55
Quantizing Vertical Output Voltages	55
Combo Mode: Switches	56
Assigning Switch Functionality To A Pad	57
Using Switches	58
Combo Mode: LFO	59
Assigning LFO Functionality To A Pad	60
Using an LFO (Overview)	61
LFO Basics	61
Locking the LFO Rate	62
Attenuating the LFO Output	62
Unipolar, Bipolar and Quantized LFOs	63

Combo Mode: Voltage Banks	64
Assigning Voltage Bank Functionality To A Pad	65
Using Voltage Banks	66
Sending Voltages	66
Setting Voltages Manually	67
Setting Voltages Randomly	67
Slewing Between Voltages	67
Quantizing Voltages	67
PART FOUR: NOTES MODE	69
NOTES MODE	70
Entering Notes Mode	72
Setting the Number of Virtual Keys	73
Tuning Mode	74
Choosing a Note Assignment Method	74
Set Notes by Scale	75
Assigning Notes to the Tetrapad 'Keyboard' w/Scale	77
Playing the Keyboard	78
Slew Between Notes	80
Set Notes by Chord	81
Assigning Notes to the Tetrapad 'Keyboard' w/Chord	83
Playing Chords	84
Slew Between Chords	85
Copying & Pasting Chords	86
Set Notes Manually	87
Assigning Notes to the Tetrapad 'Keyboard' Manually	89
Playing the Keyboard	90
Slew Between Notes	90
Rotating and Inverting	90
Copying & Pasting Notes	91
Edit View for Notes Mode	92

PART FIVE: VOLTAGES MODE	93
VOLTAGES MODE	94
Entering Voltages Mode	95
Setting the Number of Voltage Banks	96
Assigning Voltage Values	96
Manual Voltage Assignment	96
Random Voltage Assignment	98
Reset a Voltage	99
Slew Between Voltages	99
Quantizing Voltage Values	99
Edit View for Voltages Mode	100
Copying & Pasting Voltage Banks	101
PART SIX: MENUS	102
MENU OVERVIEW	103
MODE Select Menu	104
Mode SETUP Menu	104
Combo Mode SETUP Menu	105
Notes Mode SETUP Menu	109
Voltages Mode SETUP Menu	112
Global Setup Menu	115
System Mode	116
CV Setup Menu	117
CV Setup: SYNC Output	118
CV Setup: Output A	119
CV Setup: Output B	120
CV Setup: TRIG and RESET Inputs	120
CV Setup: RESET Input	121
CV Setup: Input X, Y and Z (Notes Mode)	122

CV Setup: Input X, Y and Z (Voltages Mode)	126
CV Setup: Input X, Y and Z (Combo Mode)	133
Reset CV	138
FILE Menu	139
TEMPO Menu	142
PART SEVEN: LOOPING & SEQUENCING	143
THE LOOPER	144
Combo Mode Looping	145
Record & Play with Touch Sync	146
Record & Play with Looper Sync	148
Record & Play Unsynced	150
Overdubbing	151
The Encoder Bar (In Looper)	152
Combo Mode Encoder Bar (Looper)	152
Notes Mode Encoder Bar (Looper)	152
Voltages Mode Encoder Bar (Looper)	153
Save, Load, Rename and Delete Loops	154
THE SEQUENCER	155
Record & Play A Note Sequence	155
Recording a Note Sequence	156
Playing Back a Note Sequence	157
Record & Play A Voltage Sequence	158
Recording a Voltage Sequence	159
Playing Back a Voltage Sequence	160
Editing Sequences	161
Appending Sequences	161
Overwriting Sequences	162
Inserting Into Sequences	162
Overdubbing Sequences	163
Save, Load, Rename and Delete Sequences	164

LOOPY	164
Loopy with Sequences	165
Loopy Length with Sequences	166
Loopy Shift with Sequences	166
Position Sync with Sequences	167
Loopy with Loops	169
Loopy Shift with Loops	170
Position Sync with Loops	171
PART EIGHT: MISCELLANEOUS	172
CALIBRATION	173
Calibrating Tête	173
Calibrating Tetrapad	175
FIRMWARE UPDATES	178
Displaying Tetrapad Firmware Version on Tête	178
Displaying Tetrapad Firmware Version on Tetrapad	178
Version 3 Firmware Display Method	179
Version 1 & 2 Firmware Display Method	180
Firmware Change Log	181
TECHNICAL SPECIFICATIONS	183

COMPLIANCE



This device complies with Part 15 of the FCC Rules. Operation is subject to the following two conditions: (1) this device may not cause harmful interference, and (2) this device must accept any interference received, including interference that may cause undesired operation.

Changes or modifications not expressly approved by Intellijel Designs, Inc. could void the user's authority to operate the equipment.

Any digital equipment has been tested and found to comply with the limits for a Class A digital device, pursuant to part 15 of the FCC Rules. These limits are designed to provide reasonable protection against harmful interference when the equipment is operated in a commercial environment. This equipment generates, uses, and can radiate radio frequency energy and, if not installed and used in accordance with the instruction manual, may cause harmful interference to radio communications.



This device meets the requirements of the following standards and directives:

EMC: 2014/30/EU

EN55032:2015 ; EN55103-2:2009 (EN55024) ; EN61000-3-2 ; EN61000-3-3

Low Voltage: 2014/35/EU

EN 60065:2002+A1:2006+A11:2008+A2:2010+A12:2011

RoHS2: 2011/65/EU

WEEE: 2012/19/EU

PART ONE:
INSTALLATION

INSTALLATION

Intellijel Eurorack modules are designed to be used with a Eurorack-compatible case and power supply. We recommend you use Intellijel cases and power supplies.

Before installing these modules in your case, you must ensure your power supply has a free power header and sufficient available capacity to power the modules:

- Sum up the specified +12V current draw for all modules, including the new ones. Do the same for the -12 V and +5V current draw. The current draw will be specified in the manufacturer's technical specifications for each module.
- Compare each of the sums to specifications for your case's power supply.
- Only proceed with installation if none of the values exceeds the power supply's specifications. Otherwise you must remove modules to free up capacity or upgrade your power supply.

You will also need to ensure your case has enough free space (hp) to fit the new modules. To prevent screws or other debris from falling into the case and shorting any electrical contacts, do not leave gaps between adjacent modules, and cover all unused areas with blank panels. Similarly, do not use open frames or any other enclosure that exposes the backside of any module or the power distribution board.

You can use a tool like [ModularGrid](#) to assist in your planning. Failure to adequately power your modules may result in damage to your modules or power supply. If you are unsure, please [contact us](#) before proceeding.

Installing Your Modules

When installing or removing modules from your case always turn off the power to the case and disconnect the power cable. Failure to do so may result in serious injury or equipment damage.

Ensure the 10-pin connector on the power cable is connected correctly to each module before proceeding. The red stripe on the cable must line up with the -12V pins on the module's power connector. Different modules use different ways to indicate the -12V pins. Some may be labelled with "-12V;" a white stripe next to the -12V pins; the words "red stripe;" or some combination of these. Additionally, some modules may have shrouded headers, thus preventing backward connections.

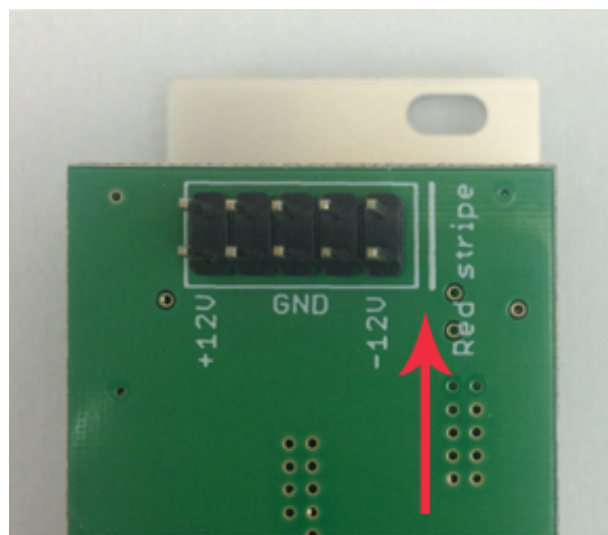

Most modules will come with the cable already connected but it is good to double check the orientation. Be aware that some modules may have headers that serve other purposes so ensure the power cable is connected to the right one.

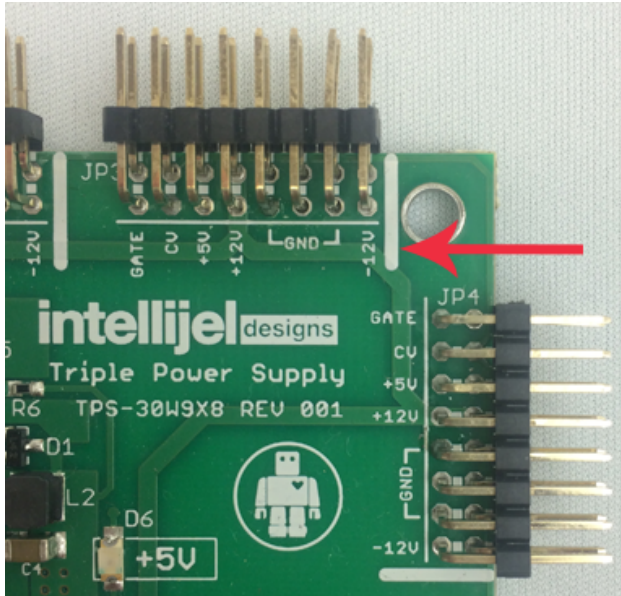

The other end of the cable, with a 16-pin connector, connects to the power bus board of your Eurorack case. Ensure the red stripe on the cable lines up with the -12V pins on the bus board. On Intellijel power supplies the pins are labelled with the label “-12V” and a thick white stripe:

If you are using another manufacturer’s power supply, check their documentation for instructions.

Once connected, the cabling between each module and power supply should resemble the picture below:

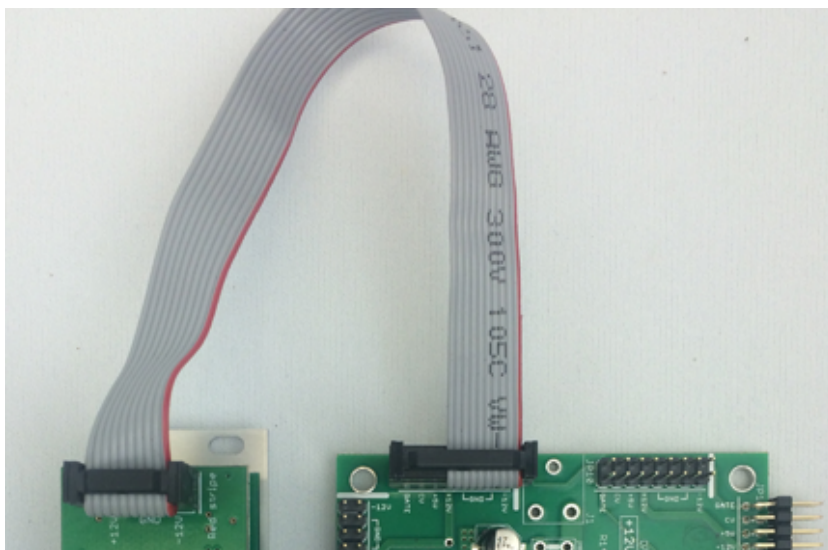

Before reconnecting power and turning on your modular system, double check that the ribbon cable is fully seated on both ends and that all the pins are correctly aligned. If the pins are misaligned in any direction or the ribbon is backwards you can cause damage to your module, power supply, or other modules.

After you have confirmed all the connections, you can reconnect the power cable and turn on your modular system. You should

immediately check that all your modules have powered on and are functioning correctly. If you notice any anomalies, turn your system off right away and check your cabling again for mistakes.

Connecting Tête to Tetrapad

IMPORTANT: Tetrapad must be running version 3.0.0.1 firmware or higher. See [Firmware Version Display](#).

You need to connect Tête and Tetrapad to each other. This is done using the included, small 6-wire i2C cable. **IMPORTANT!** : Always power down the modules before connecting or disconnecting an I2C cable!

1. Connect one end of the cable to either of the two i2C 6-pin connectors on the back panel of your Tetrapad, being sure to orient the red line with the white stripe on the circuit board. It doesn't matter which of Tetrapad's two i2C connectors you use.
2. Connect the other end of the cable to either of the two shrouded i2C 6-pin connectors on the back panel of your Tête. The connector is designed in such a way that it can only connect one way. It doesn't matter which of Tête's two i2C connectors you use.

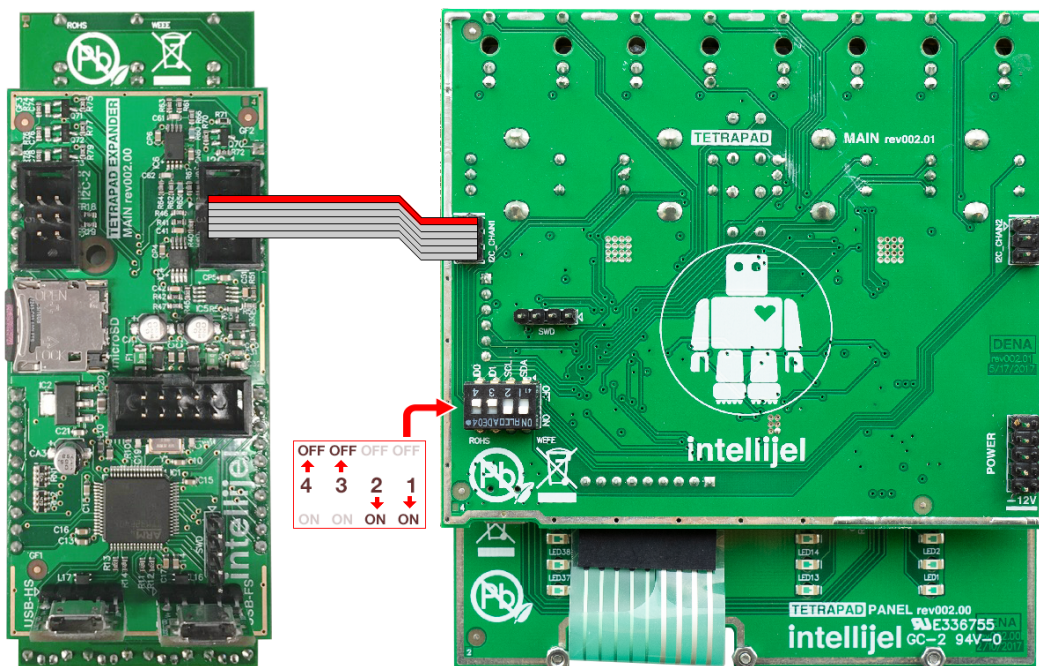

Setting Tetrapad's DIP Switches

As shown in the illustration above, you will also need to configure some DIP switches on the back of your Tetrapad in order for it to work with Tête. Specifically:

- Make sure DIP switches 1 (SDA) and 2 (SCL) are set to the ON position.
- Make sure DIP switches 3 (ID1) and 4 (ID0) are set to the OFF position.

The microSD Card

Tête ships with a 16GB Class 10, FAT32 microSD card pre-installed on the rear circuit board, which is used for storing patches, loops, sequences and various settings.

This card has been verified and tested by Intellijel, and is the only officially supported card, though it's possible others might work. One important caveat is that larger cards often have slower read times, so proceed with caution — particularly if using a larger microSD card.

If you choose to install a different card and Tête is unable to read it, then Tête will automatically format it to FAT32, and place all related files within a Tête folder on the root of the card.

2. Unlock the door by sliding it toward the edge of the board.



4. Slide the microSD card out of the door.

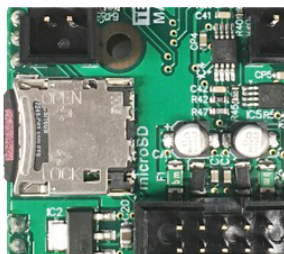

1: The SD card is mounted to the back of the Tête in a small metal door.

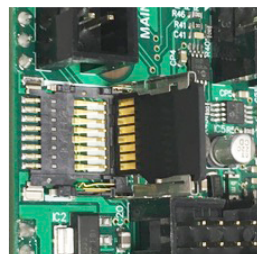
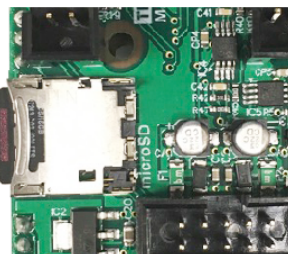

3. The door will flip open, hinged on the side away from the edge

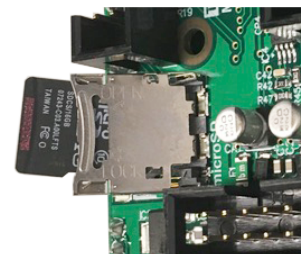

5. When dropping a card back into the door, be careful to insert it so that both edges of the card are securely in place. Close the door, and slide it back away from the edge (toward the hinge) to lock it..

PART TWO:
OVERVIEW

OVERVIEW

Tetrapad is a versatile, multi-dimensional, touch-sensitive control surface for Eurorack. Each of its four pads use force sensing resistors to respond to both the vertical position of your finger and its pressure. Four push encoders and a shift function give you even more tactile control over your modular system.

Tête connects directly to the Intellijel Tetrapad module — enhancing and expanding upon its capabilities; adding additional inputs, outputs, CV control, clocking, sequencing, looping, and many more features and modes.

IMPORTANT!

When Tête and Tetrapad are connected, they function as a single entity, controlled and configured by Tête. Tetrapad becomes a control surface and Tête provides all the “smarts.” None of the modes or configuration techniques discussed in the standalone Tetrapad manual apply when a Tête is connected, since Tête controls all Tetrapad functionality.

Tête requires a Tetrapad with firmware version 3.0.0.1 or higher. See [Firmware Version Display](#) to see how to check its firmware. Should any updates be needed, you can download them (along with update instructions) from the Intellijel.com website.

If you are using Tetrapad without Tête, please read the dedicated standalone Tetrapad manual instead.

Tête takes control of Tetrapad’s mode selection and operating functions, allowing Tetrapad to do what it does best — act as a control surface, which it does both for controlling external modules and for interfacing with the advanced processing power within Tête.

Tête + Tetrapad operates in one of three different modes:

- **Combo:** In this mode, you may assign each of Tetrapad’s four pads to its own independent function, such as: a fader; a bi-polar fader; a crossfader; LFO; a dual switch; voltage bank, or a finger drumming/euclidean rhythm pad. The chosen function determines the type of signal (CV, note, trigger, gate, etc.) sent from each of Tetrapad’s eight independent outputs, while its multitude of multi-colored LEDs keep you informed of exactly what’s happening within each mode.
- **Notes:** This mode divides Tetrapad’s four pads into 4, 8, 12, or 16 zones. Each zone is like a key on a keyboard, and can be user-configured (manually, by scale, or by chord) to output different notes to four different outputs.
- **Voltages:** This mode divides Tetrapad’s four pads into 8, 12, or 16 zones. Each zone is a voltage storage bank, which sends 8 different memorized voltages to Tetrapad’s eight outputs.

Besides taking control of (and expanding) Tetrapad's Mode assignment features, Tête offers the following additional capabilities:

- Step-recording (Sequencing) Tetrapad performances of up to 256 steps.
- Real-time recording (Looping) of Tetrapad performances. Although technically limited only by the size of the microSD card, Tête's interface is optimized for dealing with recordings less than 5 minutes.
- Loopy performance mode in both the Looper and Sequencer, for repetitive stutter effects or even granular-level looping.
- Dedicated transport controls.
- External voltage control of Tête/Tetrapad with three user-assignable CV inputs (each with dedicated attenuversion), two user-assignable gate/trig inputs, and a dedicated clock input.
- Clockable either internally or to an external clock, with full clock division and multiplication capability.
- Three additional user-assignable CV outputs.
- Visual representation of Tetrapad functions via its built-in screen
- Ability to split pads into 2, 3 or 4 zones, enabling up to 16 possible voltage banks or a 16 note virtual "keyboard."
- 99 User-presets for each Mode (Combo, Notes, and Voltages), each of which stores all the Mode Setup parameters; Tête's CV Assignments, and an associated Sequence or Loop.

Tête automatically remembers how you last configured it, and retains these settings when powered off. By default, Tête automatically and instantly saves its state whenever you make a change. This makes Tête + Tetrapad ideal for live performance, since you know it will always power up with your configurations intact. There is only one exception: if the looper or sequencer is currently playing, then Tête waits for playback to stop before saving its state, so that maximum attention is given to the timing and playback of your loop or sequence.

TETRAPAD PANEL OVERVIEW

Below is a general overview of Tetrapad's front panel. Each of these features will be discussed in detail later in the manual.

1. Pads 1-4

Four identical touch strips, each of which is sensitive to both vertical position and finger pressure. Depending on the current mode, these pads can transmit trigger signals, gate signals, quantized note values or real-time control voltages.

2. Level LEDs

Embedded beneath the surface of each pad is a 12 LED ladder. This ladder displays different parameter values in different modes. When operating as a basic fader, the LEDs represent the fader's level; when operating as note triggers, they represent the note assignment; when selecting modes, they display Combo Mode animations.

3. Push Encoders 1-4

Each of the four pads has its own associated push encoder, which functions differently depending on the current mode. For example, if Tête + Tetrapad is in Notes Mode, the encoders assign note values for each output. In Voltages Mode, the encoders assign voltage values to an output. Similarly, pressing the encoder has different functions depending on the mode. For example, if you've assigned a fader to a pad in Combo Mode, pressing an encoder latches that fader's value.

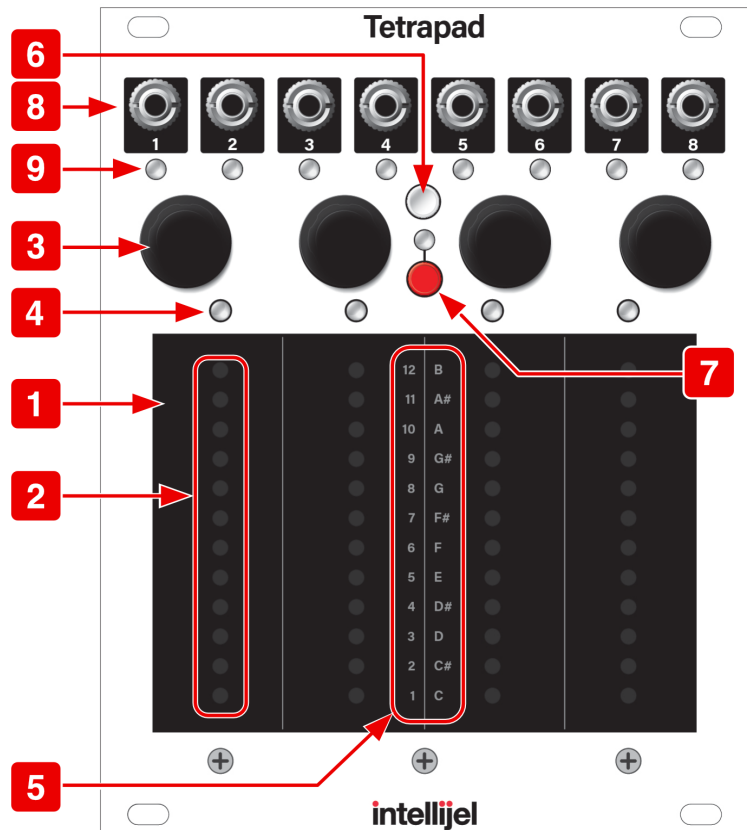

4. Pad Status LEDs 1-4

Some modes use these LEDs to indicate a pad's status. For example, they may indicate whether or not a pad's fader level is latched; or the octave to which a note is assigned.

5. Level Labels

This vertical column of text provides meaningful labels to each of the 12 vertically stacked Level LEDs. On the right are note names, which indicate pitch when appropriate to the selected mode. On the left are numbers 1-12 for indicating numerical values.

6. EDIT Button

This button has various functions depending on which mode is active.

In [Combo Mode](#), it enables you to assign different functions to different pads on Tetrapad.

In [Notes Mode](#), it's employed by various copy & paste operations, and in [Voltages Mode](#), it randomizes and resets all output voltages (when used in combination with the SHIFT button).

NOTE: The button has other functions when Tetrapad operates as a standalone module.

7. SHIFT Button & LED

Some modes offer additional features and parameters, accessible by pressing the SHIFT button. Depending on the chosen mode, the SHIFT button may be used for setting slew rates, assigning output voltage ranges, or quantizing the CV output of a pad. See the individual mode discussions to learn whether or not the SHIFT button is used, and what functions it serves. The LED immediately above the SHIFT button glows red whenever a shift feature is engaged.

8. Outputs 1-8

Outputs CV, pitch, gate or trigger signals depending on the active mode. See the detailed Modes sections to learn the function of each jack in each mode.

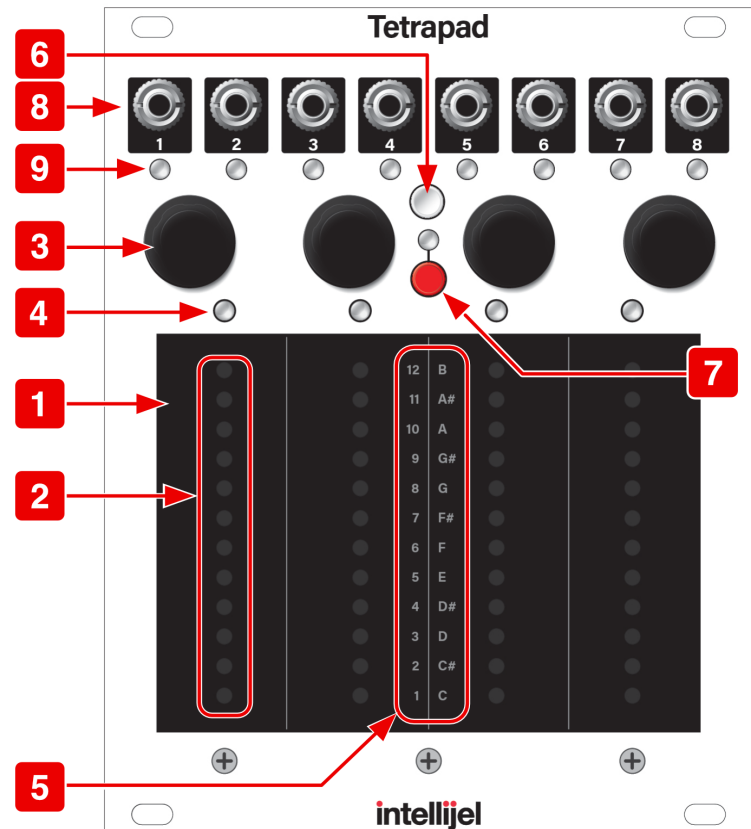



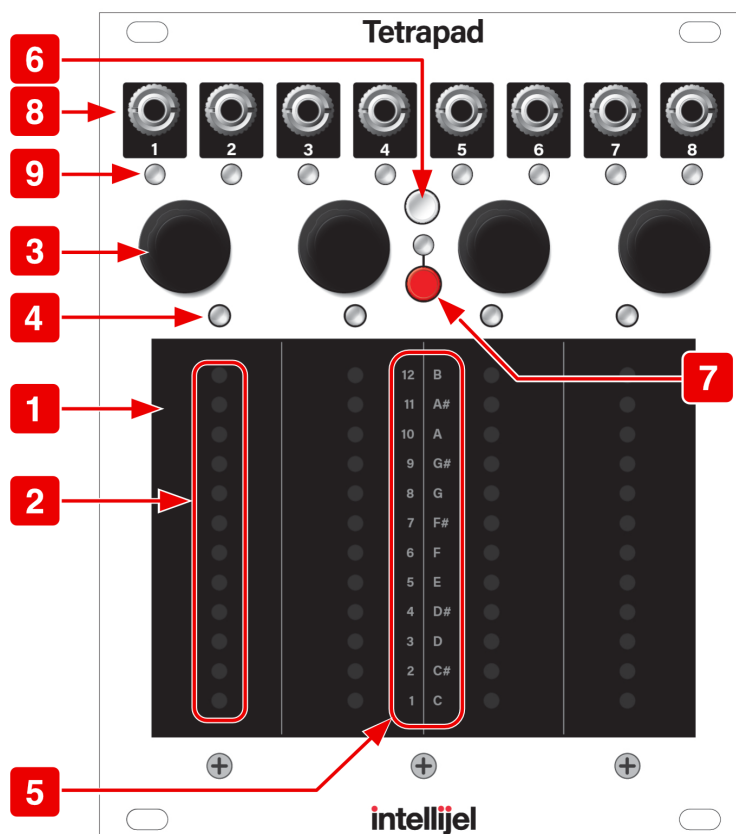

9. Output Status LEDs

In general, the color of these LEDs glow solid and indicate the type of signal appearing at the output jack for the active mode. See the table below.

When using Tetrapad, an Output Status LED's brightness (as well as its color) can provide useful status information. For example, a green (vertical position) LED gets brighter when your finger is higher up the pad; a cyan (pressure) LED gets brighter the harder you press a pad; Other modes make additional use of these status LEDs, and will be discussed in the corresponding sections.



	Blue	Pitch CV
	Magenta	Gate/Trigger
	Green	Positive Voltage (May indicate vertical position or LFO level)
	Red	Negative Voltage (May indicate vertical position or LFO level)
	Cyan	Pressure

Tête PANEL OVERVIEW

Below is a general overview of Tête’s front panel. Many of these features will be discussed in greater detail in the appropriate sections of the manual.

Outputs

1. SYNC OUT

By default the **SYNC OUT** jack is assigned to the “Clock” function (for all modes).

However, you can override the default output function for each mode using the [CV Setup Menu](#), accessed by pressing the **CV FILE** button **[D]**.

Numerous assignments are possible, including: EOL/EOS; SOL/SOS, Touch, Run, Clock, etc. See [CV Setup: SYNC Output](#) for a description of all the possible options.

2. A OUT

By default the **A OUT** jack is assigned to the “Loop Position” function (for all modes), which outputs a voltage that rises steadily from 0V (at the beginning of a loop or sequence) to +5V at the very end of the currently playing loop/sequence.

However, you can override the default output function for each mode using the [CV Setup Menu](#), accessed by pressing the **CV FILE** button **[D]**.

Numerous assignments are possible, including: Clock, Run Clock, Touch Clock, Play, Stop, Run, EOL/EOS, SOL/SOS, Touch and Loop Position. See [CV Setup: Output A](#) for a description of all the possible options.

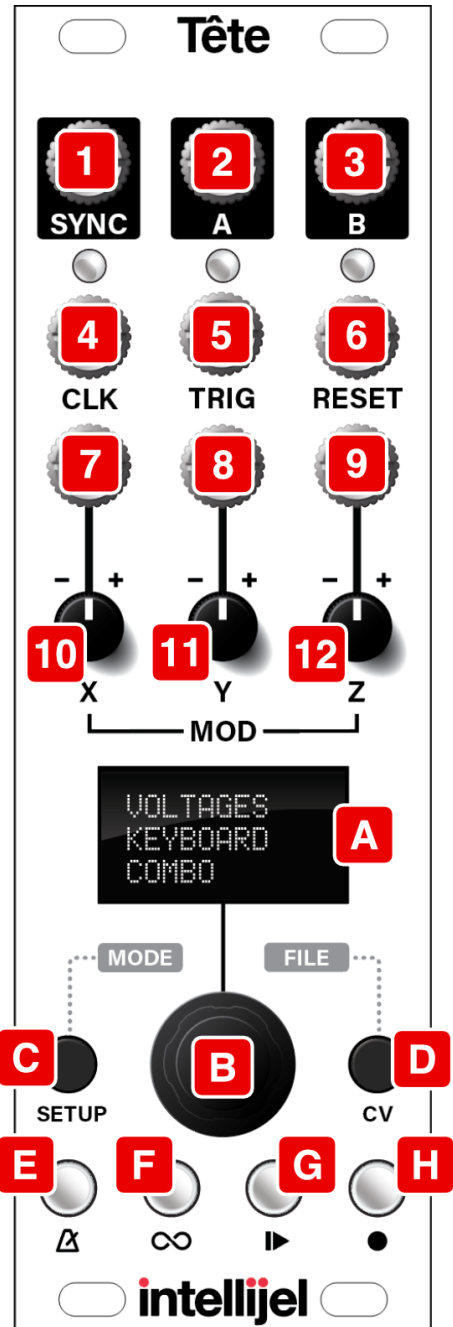

3. B OUT

By default the **B OUT** jack is assigned to the “EOL/EOS” function (for all modes), which outputs a +5V trigger at the end of the currently playing loop or sequence.

However, you can override the default output function for each mode using the [CV Setup Menu](#), accessed by pressing the **CV FILE** button **[D]**.

The list of available assignment options is the same as for the **A OUT** jack **[2]**, and is discussed in [CV Setup: Output A](#).

Inputs & Attenuverters

4. CLK IN

Connect an external clock (or any other trigger source) to this input to drive Tête’s tempo/clock based features with an external clock. Unlike the **TRIG** **[5]** and **RESET** **[6]** inputs, which can be user-assigned to perform different functions, the **CLK IN** **[4]** is always assigned to the clock.

Each time the CLK input voltage goes high, then any step-based features (such as Tête’s built-in Sequencer or a pad’s Euclidean pattern) will advance one step.

Similarly, the time between CLK triggers is used to calculate an overall tempo, which can drive Tête’s real-time looping function or its beat-synchronized LFOs.

Any clock derived from this CLK input can be multiplied or divided when using the sequencer by the clock divider feature found in Tête’s [Mode SETUP Menu](#).

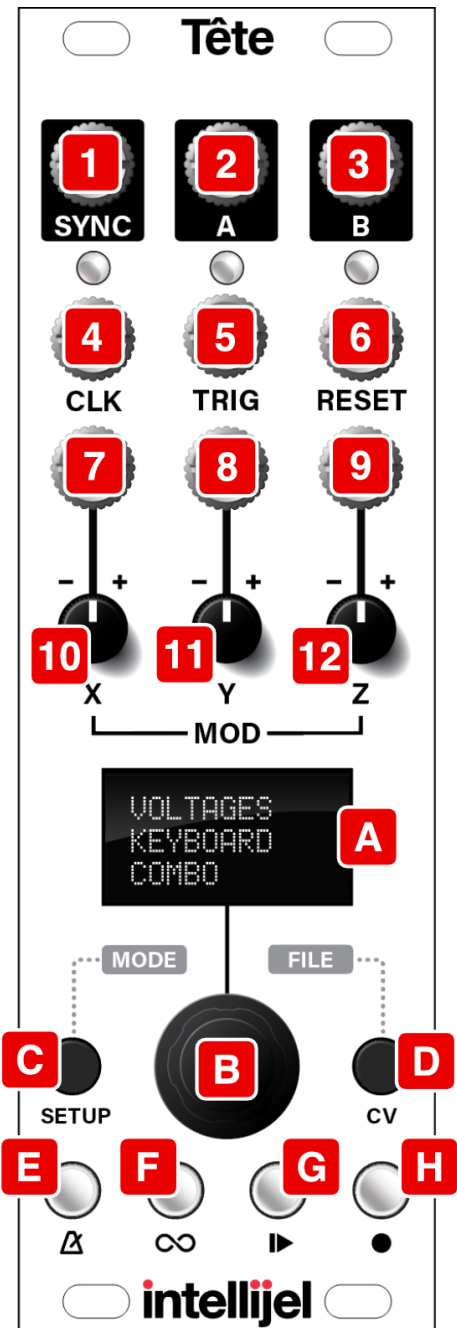

5. TRIG IN

Connect an external trigger or gate to this input, and assign that trigger/gate to control any one of a number of global functions using the [CV Setup Menu](#), accessed by pressing the **CV FILE** button **[D]**.

By default, the TRIG input is assigned to the “Bank Rand” function for Voltages Mode, meaning an input trigger selects a random bank of stored voltages. For Combo and Notes Modes, the TRIG input is unassigned by default.

You can override the default function for each mode using the [CV Setup Menu](#), accessed by pressing the **CV FILE** button **[D]**. Numerous assignments are possible, including: Reset, Run, Looper, Tggl Loopy and Gate Loopy. See [CV Setup: TRIG Input](#) for a list of all the possible destinations for this input.

6. RESET IN

Connect an external trigger or gate to this input, and assign that trigger/gate to control any one of a number of global functions using the [CV Setup Menu](#), accessed by pressing the **CV FILE** button **[D]**.

By default, the RESET input is assigned to the “Reset” function for all modes, but numerous options are available, including: Reset, Run, Looper, Tggl Loopy and Gate Loopy. See [CV Setup: RESET Input](#) for a list of all the possible input assignments.

7. X IN

Connect an external control voltage to this input, and assign that voltage to control any one of a number of global functions using the [CV Setup Menu](#), accessed by pressing the **CV FILE** button **[D]**.

By default, the X input is assigned to the “Octave” function for Notes Mode, meaning CV input controls the octave range of Tetrapad’s virtual keyboard. Each +1V signal raises the pitch of all Tetrapad notes by 1 octave. Negative voltages lower the current octave in 1V increments.

For Voltages Mode, the X input’s default assignment is the “Bank X CV” function, meaning a control voltage input selects between voltage banks along the current X-axis. To understand

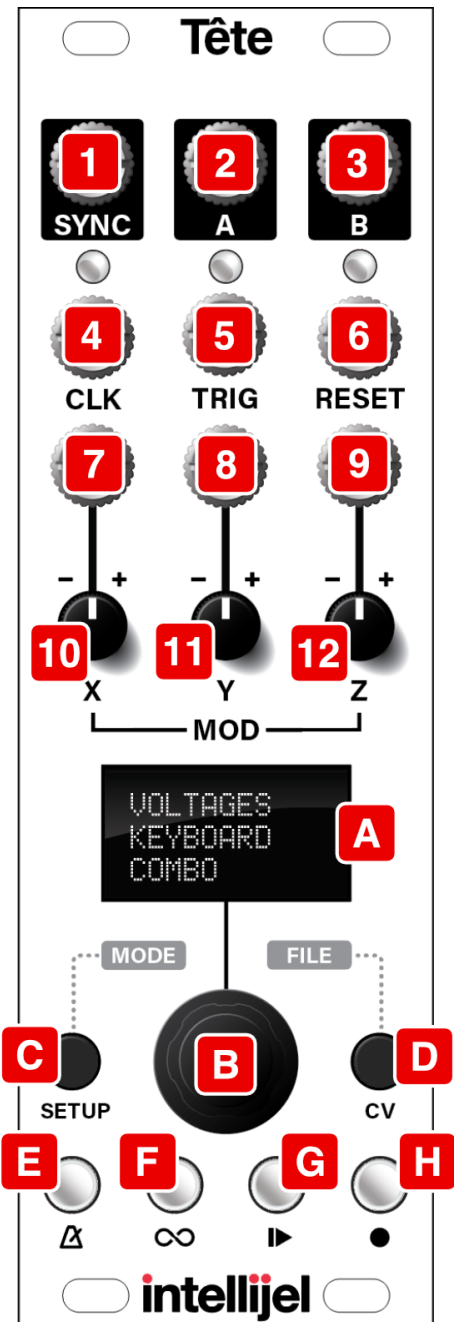

precisely what this means, see the [CV Setup: Input X, Y and Z \(Voltage Mode\)](#) discussion, later in this manual.

For Combo Mode, the X input is unassigned by default.

Numerous alternative assignments are available for each mode, including: Reset and Run options; Loopy control options, Slew control; Notes Mode assignment modifications; Voltages Mode bank changes; Combo Mode’s Euclidean and LFO features, and many more.

All the Notes Mode CV Assignment possibilities for Inputs X, Y and Z are discussed in [CV Setup: Input X, Y and Z \(Notes Mode\)](#). X, Y, and Z input options for [Voltages Mode](#) and [Combo Mode](#) are each discussed in their own sections, as well.

Voltages appearing at the X input are applied after any voltages generated by the Tetrapad itself, or by Tête’s Sequencer or Looper. In addition they can be attenuverted with the dedicated **X Attenuverter** [10].

CV inputs will read sources of up to ±10V, but only ±5V is needed to sweep the full range of the input. Use the built-in attenuverter to scale (and/or invert) voltages that exceed ±5V. Note that attenuverters are ignored for any CV assignments that read 1 V/oct.

8. Y IN

As with **X IN** [7], any voltage sent to the Y input can be assigned to control any one of a number of global functions using the [CV Setup Menu](#), accessed by pressing the **CV FILE** button [D].

By default, the Y input is assigned to the “Inversion” function for Notes Mode, meaning each 1.25V of CV input inverts the four note outputs (as if they played a chord). This function is described in detail in [CV Setup: Input X, Y and Z \(Notes Mode\)](#).

For Voltages Mode, the Y input’s default assignment is the “Bank Y CV” function, meaning a control voltage input selects between voltage banks along the current Y-axis. To understand precisely what this means, see the [CV Setup: Input X, Y and Z \(Voltage Mode\)](#) discussion, later in this manual.

For Combo Mode, the Y input is unassigned by default.

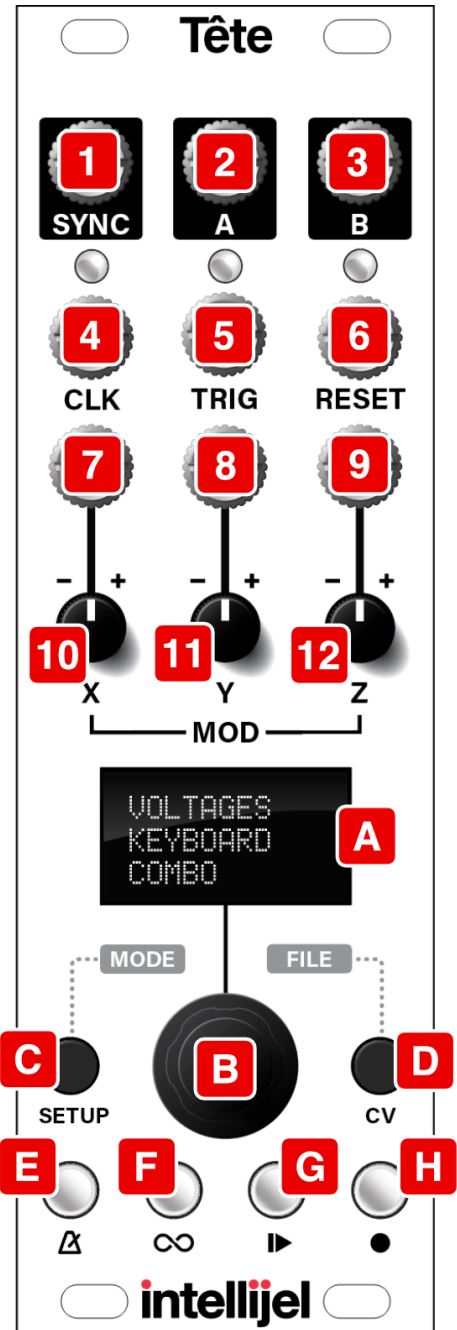

Numerous alternative assignments are available for each mode, including: Reset and Run options; Loopy control options, Slew control; Notes Mode assignment modifications; Voltages Mode bank changes; Combo Mode's Euclidean and LFO features, and many more.

All the Notes Mode CV Assignment possibilities for Inputs X, Y and Z are discussed in [CV Setup: Input X, Y and Z \(Notes Mode\)](#). X, Y, and Z input options for [Voltages Mode](#) and [Combo Mode](#) are each discussed in their own sections, as well.

Voltages appearing at the Y input are applied after any voltages generated by the Tetrapad itself, or by Tête's Sequencer or Looper. In addition they can be attenuverted with the dedicated **Y Attenuverter** [11].

CV inputs will read sources of up to $\pm 10V$, but only $\pm 5V$ is needed to sweep the full range of the input. Use the built-in attenuverter to scale (and/or invert) voltages that exceed $\pm 5V$. Note that attenuverters are ignored for any CV assignments that read 1 V/oct.

9. Z IN

As with **X IN** [7], any voltage sent to the Z input can be assigned to control any one of a number of global functions using the [CV Setup Menu](#), accessed by pressing the **CV FILE** button [D].

By default, the Z input is assigned to the "Slew" function for all modes, meaning a control voltage at the Z input controls the mode's Slew rate. Positive voltages increase the slew from the amount currently defined by the mode. Negative voltages decrease it. Note that you cannot set slew rates less than 'instantaneous' nor can you set slew rates longer than those available on Tetrapad itself.

All the Notes Mode CV Assignment possibilities for Inputs X, Y and Z are discussed in [CV Setup: Input X, Y and Z \(Notes Mode\)](#). X, Y, and Z input options for [Voltages Mode](#) and [Combo Mode](#) are each discussed in their own sections, as well.

Voltages appearing at the Z input are applied after any voltages generated by the Tetrapad itself, or by Tête's Sequencer or Looper. In addition they can be attenuverted with the dedicated **Z Attenuverter** [12].

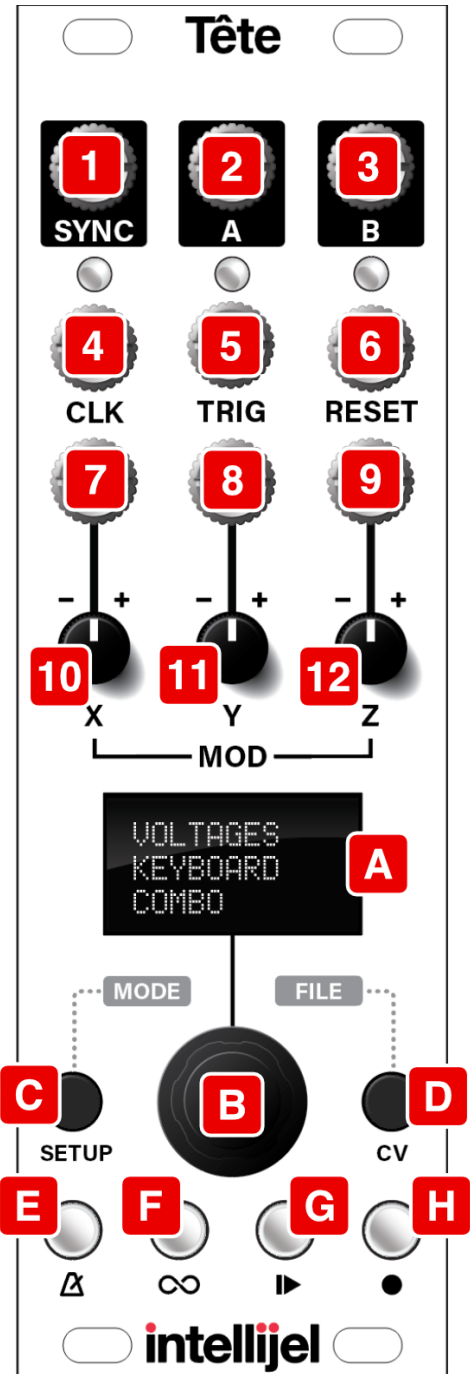

CV inputs will read sources of up to $\pm 10V$, but only $\pm 5V$ is needed to sweep the full range of the input. Use the built-in attenuverter to scale (and/or invert) voltages that exceed $\pm 5V$. Note that attenuverters are ignored for any CV assignments that read 1 V/oct.

10. X Attenuverter

Adjusts the attenuation and inversion of the voltage appearing at **X IN [7]**.

At the 12:00 o'clock position, the X input voltage is fully attenuated, and no inversion occurs.

Clockwise rotations decrease the attenuation, thus increasing the amount of X input voltage that passes through and modulates the parameter to which it's assigned. At maximum, the full value of the X input voltage is used.

Counterclockwise rotations also increase the amount that X's input voltage modulates the parameter, but it also inverts that voltage. Fully counterclockwise, the full (but inverted) value of the X input voltage is used.

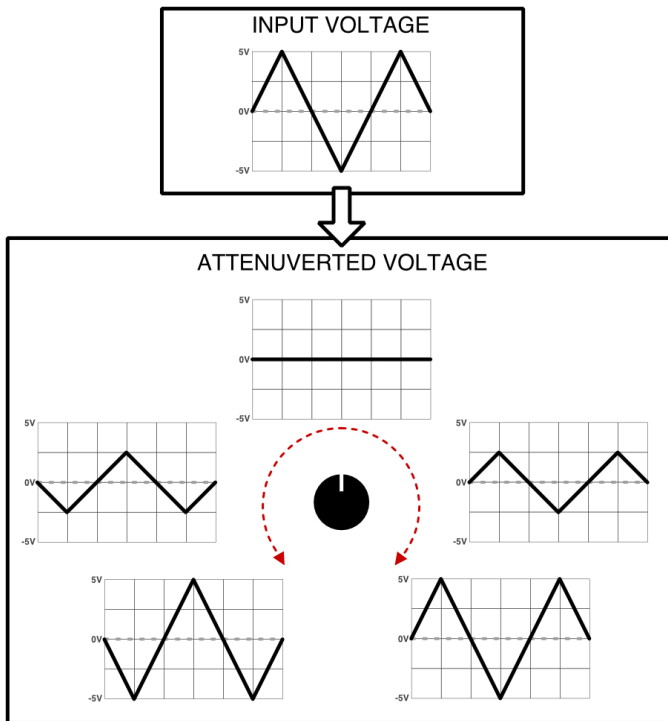

NOTE: Attenuverters are ignored for any CV assignments that read 1 V/oct.

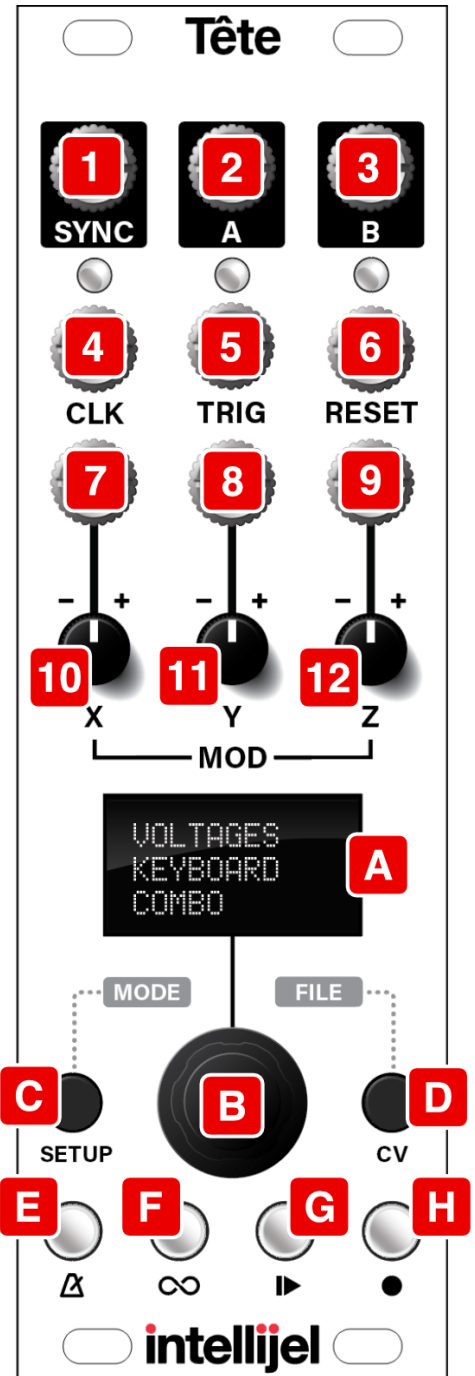

11. Y Attenuverter

Adjusts the attenuation and inversion of the voltage appearing at **Y IN [8]**, as above.

12. Z Attenuverter

Adjusts the attenuation and inversion of the voltage appearing at **Z IN [9]**, as above.

Controls

A. SCREEN

The screen provides a visual overview of everything happening on Tête, including menu selection, parameter settings, and sequencer/looper feedback.

B. SCREEN Encoder

This is a push encoder, which is used to select menus, set parameters and control screen operations. When using the [Looper](#) and [Sequencer](#) functions, the encoder's function is displayed in a dedicated "Encoder Bar" section of the display.

C. SETUP **MODE** Button

This button has two different functions:

- **SETUP**: If you press the button, it opens the Mode SETUP Menu for the current mode. This menu contains all the various configuration options for the chosen mode, as described in [Mode SETUP Menu](#).
- **MODE**: If you long-press (>1 second) the button, it launches the MODE Select Menu, where you choose the desired operating mode (Combo, Notes, or Voltages), as described in [Mode Overview](#).

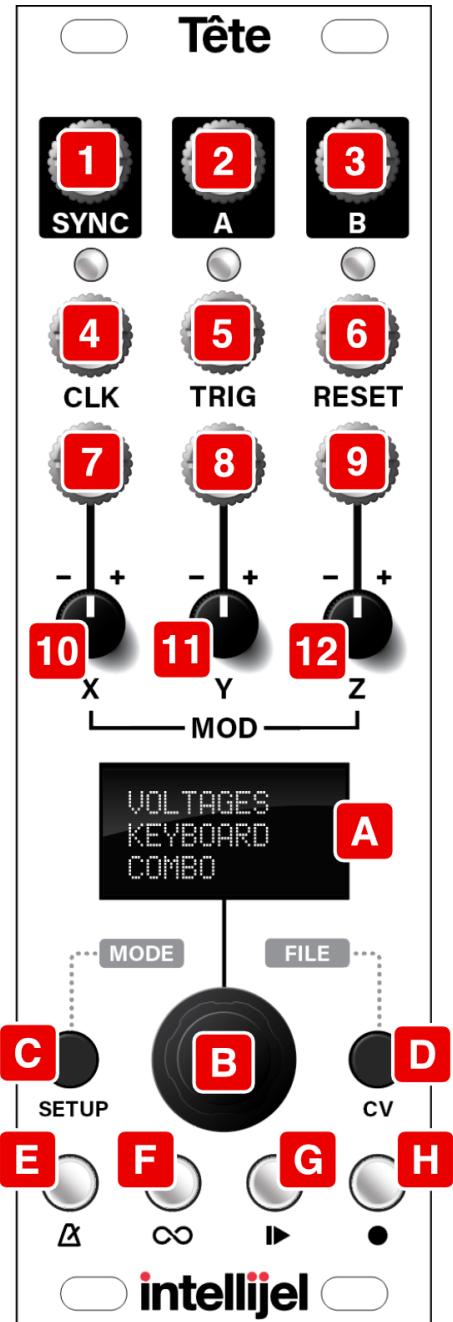

D. CV **FILE** Button

This button has two different functions:

- **CV**: If you press the button, it opens the CV Setup menu, in which you customize the CV/Gate/Trigger assignments for Tête's various input and output jacks. For more information, see [CV Setup Menu](#), later in this manual.
- **FILE**: If you long-press (>1 second) the button, it launches the FILE menu, in which you load, save, delete and rename Tête presets, as discussed later in this manual's [FILE Menu](#) section.

E. TEMPO (⏮) Button

This button controls and displays Tête's tempo, and flashes in time with it. Long-press (>1 sec) the button to display Tête's TEMPO menu, in which you can choose whether the tempo is set externally or internally. Internal tempos can be set directly in the TEMPO menu, or by tapping the TEMPO button repeatedly at the desired beat. For more information, see [TEMPO Menu](#).

F. LOOPY (∞) Button

This button turns the Loopy function on and off. Alternately, if you press-and-hold the button as a recording plays, it will temporarily engage the Loopy function for as long as the button is pressed.

Loopy is a special performance feature, which lets you play back short, looping sections taken from within a longer Sequence or Loop. It is described in detail in the [Loopy](#) section of this manual.

The button has additional utility when editing Sequences, as discussed in [The Sequencer](#).

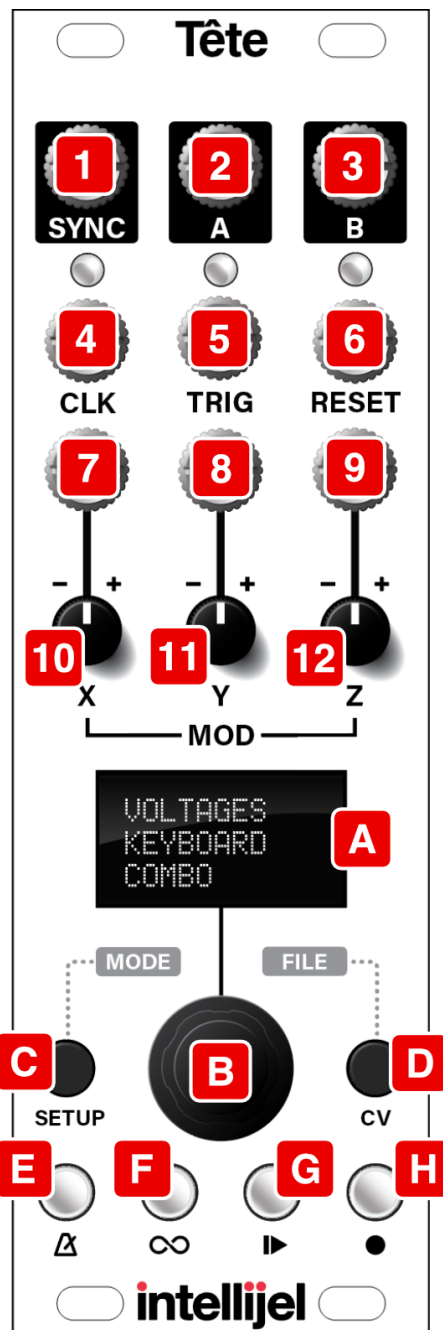

G. PLAY/PAUSE (▶) Button

Press this button to play back the active sequence or loop. Press a second time to pause playback at the current position in the sequence (the button will flash to indicate that playback is paused).

Long-press (>1 sec) this button to pause playback and reset the playhead back to the beginning of the loop or sequence.

For more information about [looping](#) and [sequencing](#), see their respective sections in this manual.

H. RECORD (●) Button

Press this button to enable recording. Press it a second time to stop recording.

Long-press (>1 sec) this button to erase the active recording.

Note that recording sometimes begins and ends immediately upon pressing this button, and sometimes it only “arms” the module while waiting for some external event to actually begin or stop the recording. For more information about [looping](#) and [sequencing](#), see their respective sections in this manual.

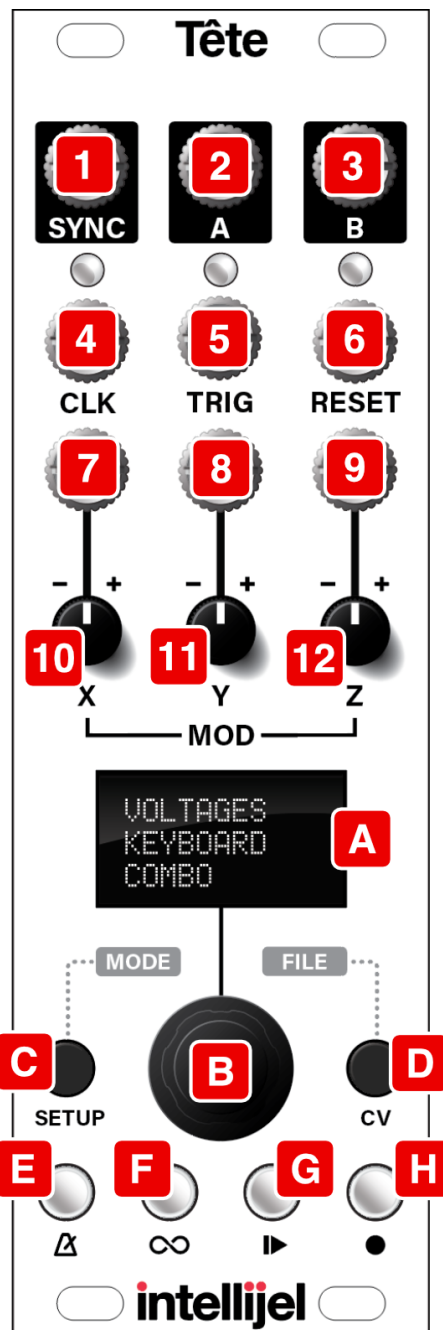

MODE OVERVIEW

Tetrapad, when controlled by Tête, offers three entirely unique modes of operation. They are:

- **COMBO MODE:** In this mode, each of Tetrapad's four pads can be assigned a function independent of the other three pads, such as: a fader; a bi-polar fader; a crossfader; an LFO; a dual switch; a voltage bank; or a finger drumming/euclidean rhythm pad. The chosen mode determines what type of signal (CV, note, trigger, gate, etc.) is sent from each of Tetrapad's eight independent outputs, while its multitude of multi-colored LEDs keep you informed of exactly what's happening within each mode. Combo Mode is discussed in [Combo Mode](#), below.

- **NOTES MODE:** This mode divides each of the four pads into either 1, 2, 3 or 4 separate zones ('keys'), which turns Tetrapad into a 4, 8, 12, or 16-key keyboard — with each 'key' capable of sending up to four different notes to four different outputs. Touching a 'key' sends different notes to Outputs 1-4, plus trigger and gate signals to Outputs 7 and 8. Vertical position and pressure are converted to CV and sent to Outputs 5 and 6, respectively.

There are three ways to assign note values to individual keys and outputs: by scale; by chord; or manually. You can set a slew time (portamento) between notes, and you can vary this time using one of Tête's CV inputs. Notes Mode is discussed in [Notes Mode](#).

Tête can also record and play back notes in real-time (using its built-in Looper) or in step-time (using its built-in Sequencer), as discussed later in [The Looper](#) and [The Sequencer](#).

- **VOLTAGES MODE:** This mode divides Tetrapad's four pads into 8, 12, or 16 zones. Each zone is a voltage storage bank, which sends 8 different memorized voltages to Tetrapad eight outputs when touched.

You can record and play back voltage changes using Tête's built-in step Sequencer or real-time Looper. The addition of Tête's CV input allows further motion sequencing by shifting zones vertically and horizontally, and you can slew between voltages, and vary the slew amount via another Tête CV input.

Voltages Mode is discussed in [Voltages Mode](#). Sequencer and Looper modes are discussed later in [The Looper](#) and [The Sequencer](#).

In addition, you can record and play back all your gestures using Tête's real-time Looper mode, as discussed in [The Looper](#).

To select modes, long-press (>1 sec) Tête's **SETUP MODE** button to display the MODE Select Menu; rotate the screen encoder to highlight the desired mode; then press the encoder to select it.

Mode operations are further refined and enhanced by setting options in the Mode SETUP Menu, as discussed in [Mode SETUP Menu](#).

PART THREE:
COMBO MODE

COMBO MODE

Combo Mode enables you to assign a unique function to each of Tetrapad's four pads and its two associated outputs. In Combo Mode, different pads can perform different functions (i.e. one pad might be an LFO; one might be a pair of switches; and two more might be assigned as faders).

Available functions in Combo Mode are:

- **Unipolar Fader**

A [Unipolar Fader](#) configures the pad as a pressure and position sensitive fader.

Slide your finger up and down the pad to operate it as a virtual fader, with the bottom position sending 0V to the pad's left output and the top position sending it maximum voltage. You can slew faders, latch them, scale the pad's output from +5V down to +1V in single volt increments, and quantize the voltage to a selected scale.

Pressure sends an additional control voltage to the pad's right output.

- **Bipolar Fader**

A [Bipolar Fader](#) configures the pad as a pressure and position sensitive fader (much like the unipolar fader), only its null (0V) position is in the center of the pad.

Bipolar faders thus act somewhat like a traditional pitch bend wheel, transmitting positive voltages to the pad's left output when your finger is above the midpoint, and negative voltages when you finger is below the midpoint.

You can slew faders, latch them, set the pad's output between +1V and +5V, and quantize the voltage to a selected scale.

Pressure sends an additional control voltage to the pad's right output.

- **Crossfader**

A [Crossfader](#) sends a pair of related voltages to the pad's two associated outputs, with the voltages changing proportionally to your finger's vertical position.

By default, the pad works as a linear crossfader, where sliding your finger up the pad increases the voltage being sent out the right jack while decreasing the voltage sent out the left jack.

Other crossfade shapes are possible, including constant power, fade, and DJ cut types. You can also latch a Crossfader, slew it, and scale the pad's output from +5V down to +1V in single volt increments.

- **Euclidean**

A [Euclidean pad](#) generates a euclidean gate pattern at the pad's left output jack, with full user control over both the number of gates and the total number of steps.

Tête must be clocked (either internally or externally) in order for the euclidean pattern to play. Euclidean rhythms can be modified in real-time, and they respect whatever swing setting is set in the Mode Menu.

The pad's right jack provides an additional source of continuous position-based modulation, which can be used to modulate another module, or quantized and sent to the pitch input of an oscillator.

Setting the euclidean sequence length to zero allows you to use a pad as simple drum trigger, in which a gate signal is sent to the pad's left output when the pad is touched, and a second CV (based on the vertical position of your finger) is sent to the pad's right output. Since each pad generates a gate no matter where you tap it, this function is ideal for finger drumming, but with the possibility of additional expression via the positional output CV.

- **Switch**

When assigned as a [Switch](#), a single pad becomes two independent switches — one on the top half of the pad (whose value appears at the pad's left output); and one on the bottom half of the pad (whose value appears at the pad's right output).

The two switches can be configured to act either as latched toggle switches or as momentary switches.

- **LFO**

When assigned as an [LFO](#), a single pad becomes a controller for a Low Frequency Oscillator (LFO), which appears at the pad's left output.

Using a combination of the pad itself, plus the SHIFT button and encoders, you can set the LFO rate, waveshape, polarity and other LFO attributes and control them in real time.

In addition, the pad responds to pressure, which (when latched) affects the LFO speed.

- **Voltage Bank**

When assigned as a [Voltage Bank](#), a single pad stores four banks of dual voltages (one each for the pad's left and right outputs). You can set voltages manually or randomize them, and one or both voltage outputs can be quantized to a chosen scale. In addition you can set a rate at which one voltage slews into another.

Entering Combo Mode

To enter Combo Mode:

1. Long-press (>1 sec) the **SETUP MODE** button to display the MODE Select Menu.
 2. Rotate the screen encoder to highlight **Combo**, then press the encoder to select it.
- The Combo Mode screen appears and Tetrapad switches to Combo Mode.

Assigning a Function to a Pad

1. Look to see if Tête is displaying the main screen. It should look something like this (depending on which functions are currently assigned to which pads):

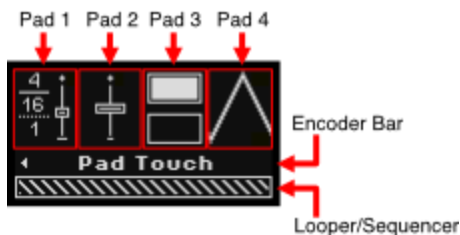

2. If Tête is currently displaying any screen other than the main screen, short-press (<1 sec) Tête's **SETUP MODE** button to display the main screen.
3. Press the white EDIT button on Tetrapad.

This puts Tetrapad/Tête into Pad Assignment Mode, which enables you to assign any of the various pad functions (discussed above) to each of the four pads.

Once in Pad Assignment Mode, Tête's main screen inverts (white background) to indicate that you are in Pad Assignment Mode, as shown below:

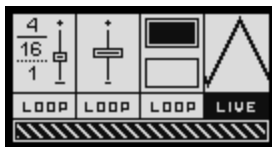

Similarly, the LEDs beneath each of Tetrapad's four pads will play an animation that's indicative of the function currently assigned to that pad (and which are discussed later).

NOTE: Also visible here is the LOOP/LIVE option (toggled by pressing the corresponding pad encoder), which determines whether or not a pad will be recorded and/or played back as part of a loop. Looper functionality is discussed in detail in [THE LOOPER](#), later in this manual.

4. Rotate Tetrapad **Encoder 1** to change the function assigned to **Pad 1**.

As you rotate the encoder, you'll see two things happen: 1) Pad 1's function icon on Tête's main screen will change as you rotate through the various functions, and 2) the Tetrapad pad animation will change to reflect the selected function.

Combo Mode's available functions are: Unipolar Fader; Bipolar Fader; Crossfader; Euclidean/Drum; Switch; LFO; and Voltage Bank.

5. Rotate Encoders 2, 3 and 4 to assign the desired function to each of the remaining three pads, and take note of the icons used in Tête's main screen, as well as the animation that plays on Tetrapad.
6. Press the white EDIT button on Tetrapad to exit Pad Assignment Mode.

Tetrapad and Tête are now ready to use.

NOTE: *Each of Combo Mode's individual Pad functions is discussed in detail in the following sections.*

Main Screen & Menus in Combo Mode

In Combo Mode, Tête's main screen offers a wealth of options and visual feedback.

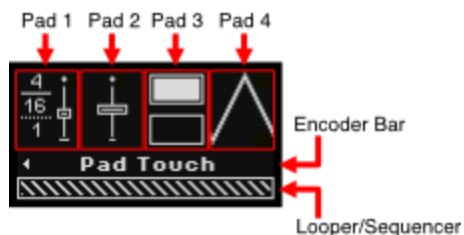

Specifically:

- **Pad (n)**

An icon is displayed for each of the four pads on Tetrapad, with the icon representing the function to which the pad is assigned. In addition, depending on the function, the icons may indicate other details, such as the pad's output voltage, latched/unlatched fader and current position, LFO waveshape/frequency, Euclidean parameters, switch states, etc. See each of the individual Combo Mode function descriptions for more information.

- **Encoder Bar**

The Encoder Bar displays recording or performance characteristics, which are set using Tête's Screen Encoder. Rotate the Screen Encoder to scroll through the various settings. A left-pointing arrow means there are more choices available by turning the Encoder counter-clockwise. A right-pointing arrow means there are more features available by turning the encoder clockwise. Since Encoder Bar functionality mostly affects recording and playback, it is discussed in [The Looper](#), later in this manual.

- **Looper/Sequencer**

This section displays relevant information when recording or playing back loops, as discussed in [The Looper](#). Note that, In Combo Mode, the step-recorder (Sequencer) is unavailable, and only the real-time recorder (Looper) is used.

Additional Combo Mode functionality is accessible through the [CV Setup Menu](#) and [Combo Mode SETUP Menu](#) as discussed later.

Combo Mode: Unipolar Fader

CLK INPUT
Clock input for syncing Tête's sequencer, looper and other clock based functions to an external clock.

TRIG / RESET INPUTS
These inputs are assignable in the CV Setup menu, which is accessed by pressing the CV button.

X / Y / Z INPUTS
The destination for each input is assignable in the CV Setup menu, which is accessed by pressing the CV button.
Use the built-in attenuverters to scale the incoming CV as needed.

SCREEN
Displays relevant parameters and menus for operating Tête and Tetrapad in Combo Mode.

BUTTONS

- SETUP**: Press to toggle between the Mode SETUP Menu on & off. Long-press to view the MODE Select Menu.
- CV**: Press to assign CV to Tête's inputs & outputs. Long-press to save, load and manage presets.

ENCODER
Sets various parameter values (see documentation)

TEMPO
Long-press to set clock options. Tap to set an internal tempo (determined by time between taps).

LOOPY
Press to toggle Loopy Mode on and off. Hold for momentary Loopy Mode.

PLAY
Press to play/pause. Long-press resets to beginning.

REC
Press to start/stop recording. Press to overdub (punch). Long-press erases recording.

COMBO MODE (UNI-POLAR FADER)

Visual indication of output voltage:

- Fader Position Level (Un-quantized)
- Fader Position Level (Quantized)
- Pressure Level

Brightness = a higher positive voltage.

WHITE: Press to enter/exit Pad Assignment Mode.

RED (SHIFT): Press to toggle Shift Mode

- NORMAL View**: Press Encoder to toggle Fader Latching
- SHIFT View**: Press Encoder to toggle Quantization (as set in the Mode Menu). Turn Encoder to scale fader level (1V - 5V). Hold the SHIFT button and turn Encoder to set the fader's slew rate.

While holding red SHIFT button:

- Turn to set a slew rate for the fader. This is the rate at which fader values change from one level to the next. Clockwise rotation increases the slew, allowing for gradual changes. Counterclockwise rotation decreases the slew, ultimately enabling instantaneous changes between fader levels (or tight tracking of finger movements on the fader).

In Normal (unshifted) view:

- Toggles Latch Mode On/Off
- Fader Is Latched
- Fader Is Not Latched
- ● Slew Rate (if unlatched) RED = more slew
- ● Slew Rate (if latched) PURPLE = more slew

Pad Assignment Indicator:
A Unipolar Fader displays a single dimly lit LED at the pad's bottom.

In Use:

- Level LEDs show fader value: 0V at bottom.
- Unlatched faders return to the bottom (zero) when you lift your finger.
- Latched faders remain at the touched level when you lift your finger.

Values slew (i.e. ramp up/down) between touched levels at a rate set by holding the red SHIFT button and turning the encoder.

Animation when assigning a Unipolar Fader

A unipolar fader converts a pad into a pressure and position sensitive fader. Slide your finger up and down the pad to operate it as a virtual fader — with the bottom position sending 0V to the pad's left output, and the top position sending 5V. You can choose whether the fader is latched or unlatched, and you can slew between fader levels. Finger pressure sends an additional control voltage to the pad's right output.

Assigning Unipolar Fader Functionality To A Pad

To assign unipolar fader functionality to one of Tetrapad's four pads:

1. Put Tête into Combo Mode, as described in [Entering Combo Mode](#), earlier.
2. Press the white EDIT button on Tetrapad to enable pad assignment.

Tête's screen will invert, and the Level LEDs embedded beneath each pad will play an animation, indicating the function currently assigned to each pad.

3. Decide which of the four pads you want to make a unipolar fader, and rotate its encoder until the unipolar fader graphic is displayed.

On Tête, the graphic for a unipolar fader looks like this:



On Tetrapad, the pad animation for a unipolar fader looks like this:

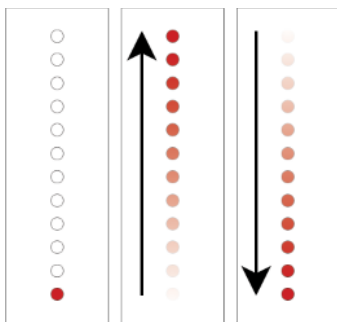

4. Press Tetrapad's white EDIT button to exit pad assignment, and the assigned pad now works as a unipolar fader.

The bottom LED is lit on the assigned pad, indicating that it will now function as a unipolar fader.

Using Unipolar Faders

1. Slide a finger up and down a pad, just as if you were moving an actual fader.

Alternately, you can simply tap a pad anywhere along its vertical scale and the fader will jump to that level directly (using a slew rate you define, as discussed shortly). Faders return to their null values when you lift your finger (unless you latch the fader by pressing the pad's encoder).

Tetrapad sends a fader's vertical position CV to its left (odd numbered) output. The Output Status LED lights green to represent the presence of a CV signal, while the brightness of the LED indicates its absolute value.

2. Press down on a pad to send an additional pressure-sensitive CV to the pad's right (even numbered) output.

The Output Status LED lights cyan to represent the presence of a pressure CV signal, while the brightness of the LED indicates its absolute value, from 0 to +5V.

3. If you want the fader to latch, press the pad's encoder.

Tête displays latched faders by putting a small line inside the thumb graphic.

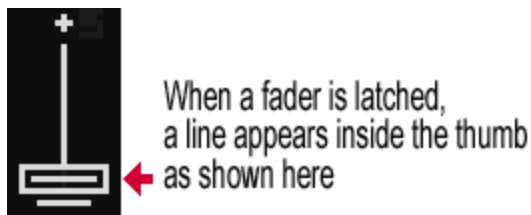

Latched faders are indicated on Tetrapad by a blue Pad Status LED. If a fader is slewed (discussed below), then the Pad Status LED turns purple instead.

When a fader is latched, it remains at the last level touched — much like a real fader on an analog mixing console. When a fader is unlatched, it snaps back to its null value when you release it — much like the spring-loaded modulation wheel used by some synths.

4. To set a fader pad's output voltage, press Tetrapad's red SHIFT button (lighting the red SHIFT LED), then rotate the pad's encoder to cycle between 1V, 2V, 3V, 4V and 5V.

Tête's screen indicates the maximum voltage value as you set it.

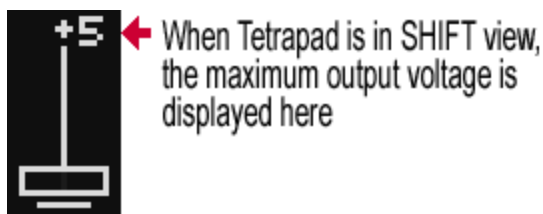

Slew Between Fader Settings

If you prefer to tap a fader (rather than drag it) or if you choose to latch a fader, you'll appreciate the ability to set the rate at which fader values move from one touched level to the next.

1. Hold down the red SHIFT button and rotate the pad's encoder to set its slew rate.

Clockwise turns increase the time it takes to move from one fader value to another (up to a maximum of about a minute to move between min/max levels). Counterclockwise turns decrease the amount of time it takes to move from one fader value to another (down to "instantaneous").

Slew times are indicated by a red Pad Status LED above the fader — with an LED glowing increasingly brighter as the slew gets longer. Since latched faders cause the Pad Status LED to turn blue, slew rates applied to a latched fader cause increasing amounts of red to mix with the blue LED, ultimately resulting in a purple LED at maximum slew rate.

Additionally, when a fader is slewed and Tête is in SHIFT view (SHIFT LED is red), then a small "S" appears to the right of the fader icon on Tête's display.

NOTE: Unlike Notes Mode or Voltages Mode, any slew applied to a pad in Combo Mode gets added before any CV-able Offsets/Level changes or voltage quantization.

Quantizing Fader Values

Fader values can be quantized to output voltages that conform to a chosen scale. To do so:

1. Press Tetrapad's red SHIFT button to display Shift View.

The red Shift View LED will light.

2. Press a pad's encoder to toggle fader quantization on/off.

When a fader is quantized, its left Output Status LED turns blue, indicating the jack contains pitched voltages. In addition, a small "Q" appears to the right of the fader icon in Tête's display.

3. On Tête, press the **SETUP MODE** button to display the Mode SETUP Menu.

4. Turn Tête's encoder to select the **Scale** and **Scale Root** options, and set them to the desired values as discussed in [Combo Mode SETUP Menu](#).

5. Press the **SETUP MODE** button again to exit the Mode SETUP Menu and return Tête to its default display.

6. Drag your finger up/down the fader and the left jack will now output pitched values conforming to the selected Scale and Root.

NOTE: Unlike Notes Mode or Voltages Mode, any quantization applied to a pad in Combo Mode happens after any CV-able Offsets/Level changes or slewing.

Combo Mode: Bipolar Fader

CLK INPUT
Clock input for syncing Tête's sequencer, looper and other clock based functions to an external clock.

TRIG / RESET INPUTS
These inputs are assignable in the CV Setup menu, which is accessed by pressing the CV button.

X / Y / Z INPUTS
The destination for each input is assignable in the CV Setup menu, which is accessed by pressing the CV button.
Use the built-in attenuverters to scale the incoming CV as needed.

SCREEN
Displays relevant parameters and menus for operating Tête and Tetrapad in Combo Mode.

BUTTONS

- SETUP** Press to toggle between the Mode SETUP Menu on & off.
Long-press to view the MODE Select Menu.
- CV** Press to assign CV to Tête's inputs & outputs.
Long-press to save, load and manage presets.

ENCODER
Sets various parameter values (see documentation)

TEMPO
Long-press to set clock options. Tap to set an internal tempo (determined by time between taps).

LOOPY
Press to toggle Loopy Mode on and off. Hold for momentary Loopy Mode.

PLAY
Press to play/pause. Long-press resets to beginning.

REC
Press to start/stop recording. Press to overdub (punch). Long-press erases recording.

COMBO MODE (BI-POLAR FADER)

Visual indication of output voltage:

- Positive Fader Position Level
- Negative Fader Position Level
- Fader Position Level (Quantized)
- Pressure Level

Brightness of LED = higher absolute voltage.

WHITE: Press to enter/exit Pad Assignment Mode.

RED (SHIFT): Press to toggle Shift View

- NORMAL View**
Press Encoder to toggle Fader Latching
- SHIFT View**
Press Encoder to toggle Quantization (as set in the Mode Menu).
Turn Encoder to scale fader level (1V - 5V)
Hold the SHIFT button and turn Encoder to set the fader's slew rate.

While holding red SHIFT button:

- Turn to set a slew rate for the fader. This is the rate at which fader values change from one level to the next.
Clockwise rotation increases the slew, allowing for gradual changes.
Counterclockwise rotation decreases the slew, ultimately enabling instantaneous changes between fader levels (or tight tracking of finger movements on the fader).

In Normal (unshifted) view:
Toggles Latch Mode On/Off

- Fader Is Latched
- Fader Is Not Latched
- Slew Rate (if unlatched) RED = more slew
- Slew Rate (if latched) PURPLE = more slew

Pad Assignment Indicator:
A Bipolar Fader displays two dimly lit LEDs in the pad's center.

In Use:

- Level LEDs show fader value: 0V at bottom.
- Unlatched faders return to the bottom (zero) when you lift your finger.
- Latched faders remain at the touched level when you lift your finger.

Values slew (i.e. ramp up/down) between touched levels at a rate set by holding the red SHIFT button and turning the encoder.

Animation when assigning a Bipolar Fader

A bipolar fader converts a pad into a pressure and position sensitive fader (much like a unipolar fader), but with its null (0V) position in the *center* of the pad. This means it transmits positive voltages to the pad's left output when touched above the midpoint, and negative voltages when touched below the midpoint. You can choose whether the fader is latched or unlatched, and you can slew between fader levels. In addition, pressing down on a fader sends an additional control voltage to the pad's right output.

Assigning Bipolar Fader Functionality To A Pad

To assign bipolar fader functionality to one of Tetrapad's four pads:

1. Put Tête into Combo Mode, as described in [Entering Combo Mode](#), earlier.
2. Press the white EDIT button on Tetrapad to enable pad assignment.
Tête's screen will invert, and the Level LEDs embedded beneath each pad will play an animation, indicating the function currently assigned to each pad.
3. Decide which of the four pads you want to make a bipolar fader, and rotate its encoder until the bipolar graphic is displayed.

On Tête, the graphic for a bipolar fader looks like this:



On Tetrapad, the pad animation for a bipolar fader looks like this:

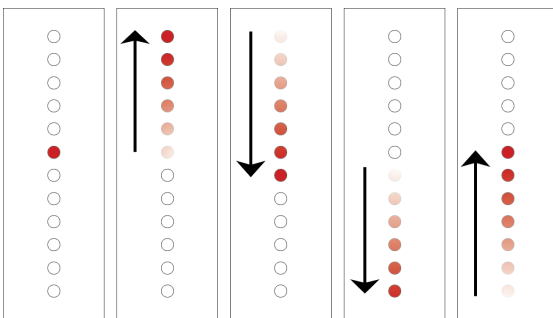

4. Press Tetrapad's white EDIT button to exit pad assignment, and the assigned pad now works as a bipolar fader.

The middle two LEDs are lit on the assigned pad, indicating that it will now function as a bipolar fader.

Using Bipolar Faders

1. Slide a finger up and down a pad, just as if you were moving an actual fader.

Alternately, you can simply tap a pad anywhere along its vertical scale and the fader will jump to that level directly (using a slew rate you define, as discussed shortly). Faders return to their null values when you lift your finger (unless you latch the fader by pressing the pad's encoder).

Tetrapad sends a fader's vertical position CV to its left (odd numbered) output. If you touch the pad above center, the Output Status LED lights green (indicating a positive voltage). If you touch the pad below center, the Output Status LED lights red (indicating a negative voltage). The brightness of the LED indicates the absolute value of the voltage.

2. Press down on a pad to send an additional pressure-sensitive CV to the pad's right (even numbered) output.

The Output Status LED lights cyan to indicate the presence of a pressure CV signal, while the brightness of the LED indicates its absolute value, from 0 to +5V.

3. If you want to latch the fader, press the pad's encoder.

Tête displays latched faders by putting a small line inside the thumb graphic.

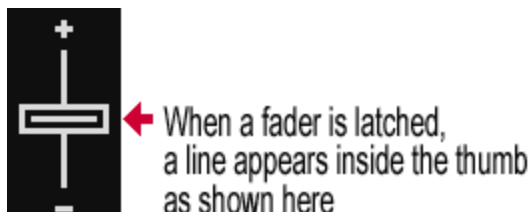

Latched faders are indicated on Tetrapad by a blue Pad Status LED. If a fader is slewed (discussed below), then the Pad Status LED turns purple instead.

When a fader is latched, it remains at the last level touched. When a fader is unlatched, it snaps back to its central value when you release it, much like a pitch-bend wheel on a MIDI keyboard.

5. To set a fader pad's output voltage, press Tetrapad's red SHIFT button (lighting the red SHIFT LED), then rotate the pad's encoder to cycle between 1V, 2V, 3V, 4V and 5V.

Tête's screen indicates the maximum voltage value as you set it.

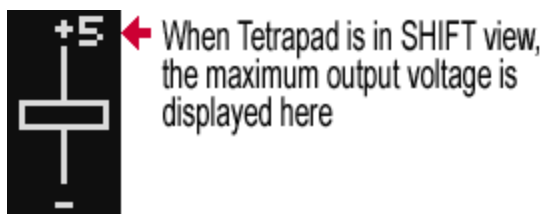

Slew Between Fader Settings

If you prefer to tap a fader (rather than drag it) or if you choose to latch a fader, you'll appreciate the ability to set the rate at which fader values move from one touched level to the next.

1. Hold down the red SHIFT button and rotate the pad's encoder to set its slew rate.

Clockwise turns increase the time it takes to move from one fader value to another (up to a maximum of about a minute to move between min/max levels). Counterclockwise turns decrease the amount of time it takes to move from one fader value to another (down to "instantaneous").

Slew times are indicated by a red Pad Status LED above the fader — with an LED glowing increasingly brighter as the slew gets longer. Since latched faders cause the Pad Status LED to turn blue, slew rates applied to a latched fader cause increasing amounts of red to mix with the blue LED, ultimately resulting in a purple LED at maximum slew rate.

Additionally, when a fader is slewed and Tête is in SHIFT view (SHIFT LED is red), then a small "S" appears to the right of the fader icon on Tête's display (though it may be obscured by a centered fader 'thumb').

NOTE: Unlike Notes Mode or Voltages Mode, any slew applied to a pad in Combo Mode gets added before any CV-able Offsets/Level changes or voltage quantization.

Quantizing Fader Values

Fader values can be quantized to output voltages that conform to a chosen scale. To do so:

1. Press Tetrapad's red SHIFT button to display Shift View.
The red Shift View LED will light.
2. Press a pad's encoder to toggle fader quantization on/off.
When a fader is quantized, its left Output Status LED turns blue, indicating the jack contains pitched voltages. In addition, a small "Q" appears to the right of the fader icon in Tête's display.
3. On Tête, press the **SETUP MODE** button to display the Mode SETUP Menu.
4. Turn Tête's encoder to select the **Scale** and **Scale Root** options, and set them to the desired values as discussed in [Combo Mode SETUP Menu](#).
5. Press the **SETUP MODE** button again to exit the Mode SETUP Menu and return Tête to its default display.
6. Drag your finger up/down the fader and the left jack will now output pitched values conforming to the selected Scale and Root.

NOTE: Unlike Notes Mode or Voltages Mode, any quantization applied to a pad in Combo Mode happens after any CV-able Offsets/Level changes or slewing.

Combo Mode: Crossfader

CLK INPUT
Clock input for syncing Tête's sequencer, looper and other clock based functions to an external clock.

TRIG / RESET INPUTS
These inputs are assignable in the CV Setup menu, which is accessed by pressing the CV button.

X / Y / Z INPUTS
The destination for each input is assignable in the CV Setup menu, which is accessed by pressing the CV button.
Use the built-in attenuverters to scale the incoming CV as needed.

SCREEN
Displays relevant parameters and menus for operating Tête and Tetrapad in Combo Mode.

BUTTONS

- SETUP** Press to toggle between the Mode SETUP Menu on & off.
Long-press to view the MODE Select Menu.
- CV** Press to assign CV to Tête's inputs & outputs.
Long-press to save, load and manage presets.

ENCODER
Sets various parameter values (see documentation)

TEMPO
Long-press to set clock options. Tap to set an internal tempo (determined by time between taps).

LOOPY
Press to toggle Loopy Mode on and off.
Hold for momentary Loopy Mode.

PLAY
Press to play/pause.
Long-press resets to beginning.

REC
Press to start/stop recording
Press to overdub (punch).
Long-press erases recording.

COMBO MODE (CROSSFADER)

Visual indication of output voltage:

- **Crossfader Position Level**
Brightness = a higher positive voltage.

WHITE: Press to enter/exit Pad Assignment Mode.

RED (SHIFT): Press to toggle Shift View

- NORMAL View**
Turn Encoder to select the crossfade type.
Press Encoder to toggle fader latching.
- SHIFT View**
Turn Encoder to scale fader level (1V - 5V)
Hold the SHIFT button and turn the Encoder to set the crossfader's slew rate.

- NORMAL view** - nudges crossfade value of a latched crossfader when the Looper isn't playing.
- Hold SHIFT button and turn encoder to set the crossfader's slew rate.
- SHIFT View** - Scales output level of crossfader (from 1V to 5V).
- NORMAL view** - Toggles Latch Mode On/Off
- SHIFT View** - Cycles through Crossfade types: Linear > Constant Power > Fade > DJ Cut

- Fader Is Latched**
- Fader Is Not Latched**
- Slew Rate (if unlatched)**
RED = more slew
- Slew Rate (if latched)**
PURPLE = more slew

Pad Assignment Indicator:
A Crossfader displays four LEDs in the center of the pad, with the middle two dimmed.

-
-
-
-

In Use:
Drag finger up/down to fade up/down voltage values sent to left and right output jacks using a crossfade type set by turning the pad's encoder.
Unlatched crossfaders return to center when you lift your finger.
Latched faders remain at the touched level when you lift your finger.

Values slew (i.e. ramp up/down) between touched levels at a rate set by holding the red SHIFT button and turning the encoder.

Animation when assigning a Crossfader

A Crossfader sends a pair of related voltages to the pad's two associated outputs, with the voltages changing proportionally to your finger's vertical position.

By default, the pad works as a *linear crossfader*: touching the bottom of a pad sends +5V to the pad's left jack and 0V to the right jack. As your finger slides up the pad, the voltage sent to the left jack decreases, while the voltage sent to the right jack increases. At the midpoint, 2.5V is sent out each of the two jacks. Sliding your finger toward the top results in more voltage at the right jack than the left until, at the very top, 0V is sent out the left jack and +5V is sent out the right.

Other crossfade shapes are possible, including constant power, fade, and DJ cut. You can latch a crossfader, nudge it, slew it, and scale the pad's output from +5V down to +1V in single volt increments.

Assigning Crossfader Functionality To A Pad

To assign crossfader functionality to one of Tetrapad's four pads:

1. Put Tête into Combo Mode, as described in [Entering Combo Mode](#), earlier.
2. Press the white EDIT button on Tetrapad to enable pad assignment.
Tête's screen will invert, and the Level LEDs embedded beneath each pad will play an animation, indicating the function currently assigned to each pad.
3. Decide which of the four pads you want to make a crossfader, and rotate its encoder until the crossfader graphic is displayed.

On Tête, the graphic for a crossfader looks like this:

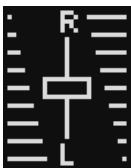

On Tetrapad, the pad animation for a crossfader looks like this:

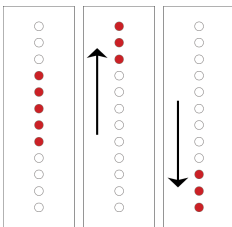

4. Press Tetrapad's white EDIT button to exit pad assignment, and the assigned pad now works as a crossfader.

The four center LEDs are lit on the assigned pad (the middle two being dimmed) to indicate that it will now function as a crossfader.

Selecting a Crossfader Type

In general, a crossfader sends a pair of related voltages to the pad's two associated outputs, with the voltages changing proportionally to your finger's vertical position. The exact relationship between these two voltages is determined by the selected crossfader type.

You can select one of four crossfader types by pressing Tetrapad's red SHIFT button (making the LED glow red), then pressing the pad's encoder to step through the available shapes. The crossfader icon on Tête changes to illustrate which type of crossfader you select. Specifically:

Constant Voltage (Linear):

Putting your finger on the bottom of a pad sends 0V to the pad's right jack and 100% of the maximum voltage to the left jack. As you drag your finger up the pad, more voltage is sent to the right jack and less to the left until, at the midpoint, 50% of the maximum voltage is sent out each jack. Sliding your finger further up the pad continues to increase the right jack voltage and decrease the left until, at the very top, 100% of the maximum voltage is being sent to the right jack and 0V to the left.

NOTE: In Shift view, you can turn an encoder to set a crossfader's maximum voltage to either 1V, 2V, 3V, 4V or 5V, with 5V being the default value (as discussed in [Using Crossfaders](#), below).

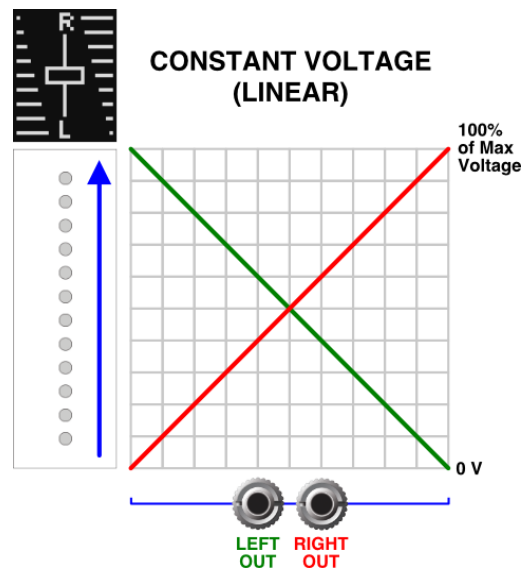

Constant Power:

Constant power is similar to linear mode, except the crossfade shape is curved, rather than linear. Constant Power is particularly useful when used to control audio, since the curved response creates a perception of constant loudness across the entire fade length. For this reason, at the midpoint of the pad, 70.7% of the maximum voltage is sent to each output, rather than 50%.

NOTE: In Shift view, you can turn an encoder to set a crossfader's maximum voltage to either 1V, 2V, 3V, 4V or 5V, with 5V being the default value (as discussed in [Using Crossfaders](#), below).

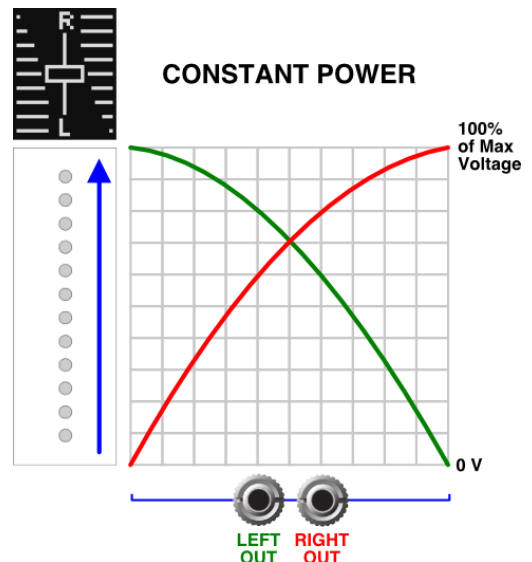

Fade:

This type of crossfader sends 100% of the maximum voltage to both the left and right jacks when your finger is in the middle of the pad.

Sliding your finger up the pad (from center) decreases the voltage being sent to the left output until, at the top of the pad, 0V is sent to the left jack.

Sliding your finger down the pad (from center) decreases the voltage being sent to the right output until, at the very bottom of the pad, 0V is sent to the right jack.

NOTE: In Shift view, you can turn an encoder to set a crossfader's maximum voltage to either 1V, 2V, 3V, 4V or 5V, with 5V being the default value (as discussed in [Using Crossfaders](#), below).

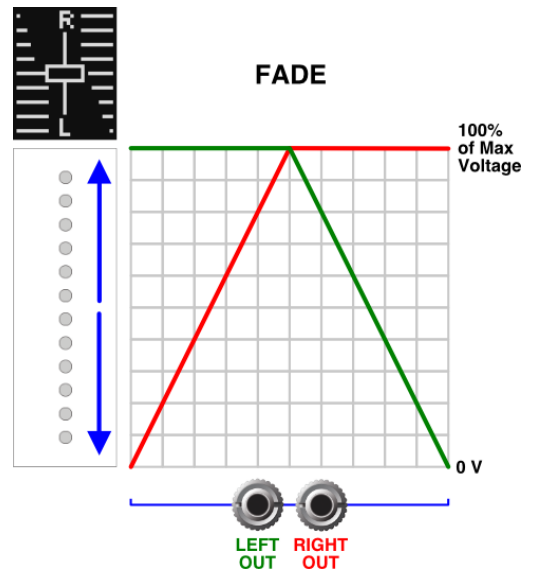

DJ Cut:

This type of crossfader is similar to the Fade type (above), except that the left output fades away only in the top 20% of the pad (rather than the top half of the pad), while the right output fades away only in the bottom 20% of the pad.

Maximum voltage is therefore sent out both jacks for a wide swath throughout the middle range of the pad.

NOTE: In Shift view, you can turn an encoder to set a crossfader's maximum voltage to either 1V, 2V, 3V, 4V or 5V, with 5V being the default value (as discussed in [Using Crossfaders](#), below).

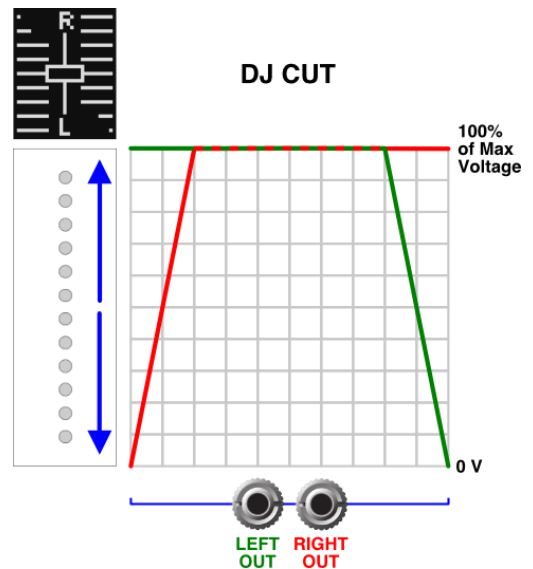

Using Crossfaders

1. Slide a finger up and down a pad, just as if you were moving an actual crossfader.

Alternately, you can simply tap a pad anywhere along its vertical scale and the crossfader will jump to that level directly (using a slew rate you define, as discussed below). Crossfaders return to their null values when you lift your finger (unless you latch them by pressing the pad's encoder).

Tetrapad uses the crossfader's vertical position to determine how much voltage to send to the pad's left and right output jacks, in accordance with the crossfade type (discussed above). The intensity of each Output Status LED indicates the amount of voltage being sent to the corresponding output jack. The LED lights at maximum intensity when the jack is outputting its maximum voltage level.

2. If you want the crossfader to latch, press the pad's encoder.

Latched crossfaders are indicated by a blue Pad Status LED. When a crossfader is latched, it remains at the last level touched. When a crossfader is unlatched (the Status LED is off), it snaps back to its center value when you release it.

3. If you want to nudge a latched crossfader toward one output or the other, rotate the pad's encoder when Tetrapad is not in Shift mode (red SHIFT LED is off).

You can only nudge latched Crossfaders when the Looper isn't playing.

4. To set a crossfader pad's output voltage, press Tetrapad's red SHIFT button (lighting the red SHIFT LED), then rotate the pad's encoder to cycle between 1V, 2V, 3V, 4V and 5V.

Tête's screen indicates the maximum voltage value as you set it.



← When Tetrapad is in SHIFT view,
the maximum output voltage is
displayed here

Slew Between Fader Settings

If you prefer to tap a crossfader (rather than drag it) or if you use latch mode, you'll appreciate the ability to set the rate at which crossfade values move from one touched level to the next.

1. Hold down the red SHIFT button and rotate the pad's encoder to set its slew rate.

Clockwise turns increase the time it takes to move from one crossfader value to another (up to a maximum of about a minute to move between min/max levels). Counterclockwise turns decrease the amount of time it takes to move from one fader value to another (down to "instantaneous").

Slew times are indicated by a red Pad Status LED above the crossfader — with an LED glowing increasingly brighter as the slew gets longer. Since latched crossfaders cause the Pad Status LED to turn blue, slew rates applied to a latched crossfader result in increasing amounts of red mixed with the blue LED, ultimately resulting in a purple LED at maximum slew rate.

Additionally, when a crossfader is slewed and Tête is in SHIFT view (SHIFT LED is red), then a small "S" appears to the right of the fader icon on Tête's display.

Combo Mode: Euclidean

CLK INPUT
Clock input for syncing Tête's sequencer, looper and other clock based functions to an external clock.

TRIG / RESET INPUTS
These inputs are assignable in the CV Setup menu, which is accessed by pressing the CV button.

X / Y / Z INPUTS
The destination for each input is assignable in the CV Setup menu, which is accessed by pressing the CV button.
Use the built-in attenuverters to scale the incoming CV as needed.

SCREEN
Displays relevant parameters and menus for operating Tête and Tetrapad in Combo Mode.

BUTTONS

- SETUP**
Press to toggle between the Mode SETUP Menu on & off.
Long-press to view the MODE Select Menu.
- CV**
Press to assign CV to Tête's inputs & outputs.
Long-press to save, load and manage presets.

ENCODER
Sets various parameter values (see documentation)

TEMPO
Long-press to set clock options. Tap to set an internal tempo (determined by time between taps).

LOOPY
Press to toggle Loopy Mode on and off. Hold for momentary Loopy Mode.

PLAY
Press to play/pause. Long-press resets to beginning.

REC
Press to start/stop recording. Press to overdub (punch). Long-press erases recording.

COMBO MODE (EUCLIDEAN)

Gate Signal (Pattern)
Lit = gate high. Unlit = gate low.

Vertical Position Level *

Quantized (Note) Signal *

* Brightness = a higher positive voltage (touching higher up the pad).

WHITE: Press to enter/exit Pad Assignment Mode.

RED (SHIFT): Press to toggle Shift View

NORMAL View
Press Encoder to toggle Fader Latching

SHIFT View
Press Encoder to toggle Vertical Quantization (as set in the Mode Menu).
Turn Encoder to scale output level (1V - 5V)
Hold the SHIFT button and turn Encoder to set the vertical position slew rate.

NORMAL View: Sets number of pulses (numerator) in the euclidean pattern.

Hold SHIFT button and turn encoder to set the vertical position slew rate.

SHIFT View: Scales output level of vertical position (from 1V to 5V).

NORMAL View: Push-rotate to set the euclidean pattern length (denominator).
Setting length to zero creates single hits, enabling pad to function like a drum pad.

NORMAL View: Push to latch pattern playback. Pattern can be modified while latched.

SHIFT View: Push to toggle output quantization for vertical position.

Pattern is Latched

Pattern is Not Latched

Position Slew Rate (if unlatched)
RED = more slew

Position Slew Rate (if latched)
PURPLE = more slew

Pad Assignment Indicator:
A Euclidean Pad lightly dims the top and bottom LEDs on a pad.

In Use:

The entire pad triggers a euclidean pattern (selected with the pad encoder), sending gates to the pad's left output when touched.

The pattern runs for as long as your finger is on the pad (but can be locked on with a press of the encoder).

The pad also responds to your finger's vertical positioning — the higher your finger sits on the pad, the higher the control voltage sent out the pad's right jack. Vertical changes can be slewed and/or quantized.

Animation when assigning a drum pad

A Euclidean pad generates a euclidean gate pattern at the pad's left output jack. The pad's right output provides an additional source of continuous position-based modulation, which can be used to modulate another module, or quantized and sent to the pitch input of an oscillator.

Tête must be clocked (either internally or externally) in order for the euclidean pattern to play. Euclidean rhythms can be modified in real-time, and they respect whatever swing setting is set in the Mode Menu.

Assigning Euclidean Functionality To A Pad

To assign Euclidean functionality to one of Tetrapad's four pads:

1. Put Tête into Combo Mode, as described in [Entering Combo Mode](#), earlier.
2. Press the white EDIT button on Tetrapad to enable pad assignment.
Tête's screen will invert, and the Level LEDs embedded beneath each pad will play an animation, indicating the function currently assigned to each pad.
3. Decide which of the four pads you want to make a euclidean pad, and rotate its encoder until the euclidean pad graphic is displayed.

On Tête, the graphic for a euclidean pad looks like this:

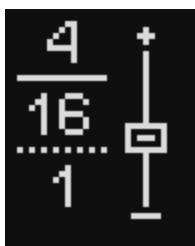

On Tetrapad, the pad animation for a euclidean pad looks like this:

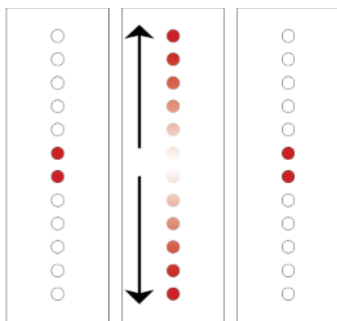

4. Press Tetrapad's white EDIT button to exit pad assignment, and the assigned pad now works as a euclidean/drum pad.

The top and bottom LEDs are lit on the assigned pad, indicating that it will now function as a euclidean/drum pad.

Using Euclidean Pads

When you assign the Euclidean function to a pad, many of its parameters are indicated by the pad graphic on Tête's screen.

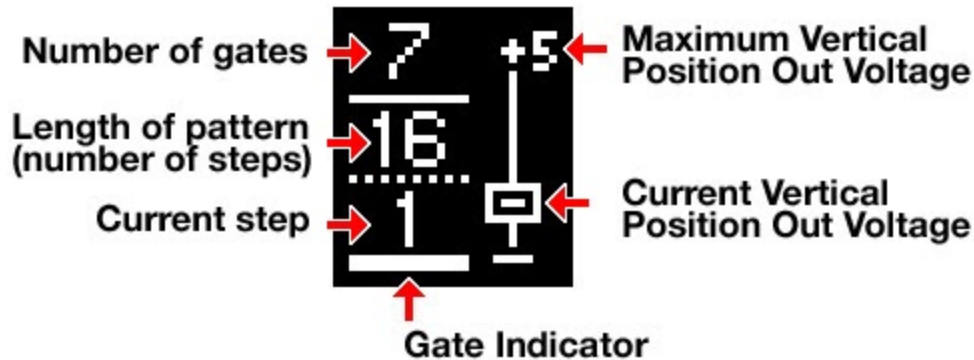

- Length of Pattern:** Displays the overall length of the euclidean pattern in number of steps. Adjust by press-turning encoder (in Normal, unshifted mode).
 This parameter can be put under CV control by assigning the “Euclidean Steps” destination to the X, Y, or Z CV inputs (as discussed in [CV Setup: Input X, Y and Z \(Combo Mode\)](#)). Press Tetrapad’s red SHIFT button to display the post-CV value using inverted text.
- Number of Gates:** Sets the number of gates (pulses), which are spread as evenly as possible across the overall length. Adjust by turning the encoder (in Normal, unshifted mode).
 This parameter can be put under CV control by assigning the “Euclidean Pulses” destination to the X, Y, or Z CV inputs (as discussed in [CV Setup: Input X, Y and Z \(Combo Mode\)](#)). In normal view, the pre-CV value is displayed. To view the post-CV value, press Tetrapad’s red SHIFT button, which inverts the text and displays the post-CV value.
- Current Step:** Shows the current step number as the pattern plays.
- Gate Indicator:** Visually indicates each gate as the pattern plays.
- Current Vertical Position Out Voltage:** Visual indication of the vertical pad position, which varies the voltage sent out the pad’s right output. Output voltage can be quantized to a scale (selected in the Mode Menu) by going into Shift Mode (Red button on Tetrapad), then pressing the encoder. When the position output is quantized, positional changes will be quantized to the pulses that are output, this avoids shaky pitch changes.
- Maximum Vertical Position Out Voltage:** Shows the voltage sent when the pad is touched at the very top. Can be scaled from +1V (max) to +5V (max) by holding the red SHIFT button and turning the encoder. This limits the overall voltage range of the pad, and can be particularly useful when the output is quantized and used to play notes.

To program a basic euclidean rhythm:

1. Set a tempo in Tête, using either its internal clock or an external clock plugged into the **CLK** input (as discussed in [Tempo Menu](#)).
2. Push-turn the pad's encoder to set the desired pattern length (number of steps).
3. Turn the pad's encoder to set the number of gates (pulses) you wish to spread as evenly as possible across the overall length (this is the euclidean rhythm).
4. Press the pad to begin playing the rhythm out the pad's left jack.

In the following example, we can see that Pad 2 has been assigned to the Euclidean function, and that it's 16 beats long with 5 euclidean gates assigned to it.

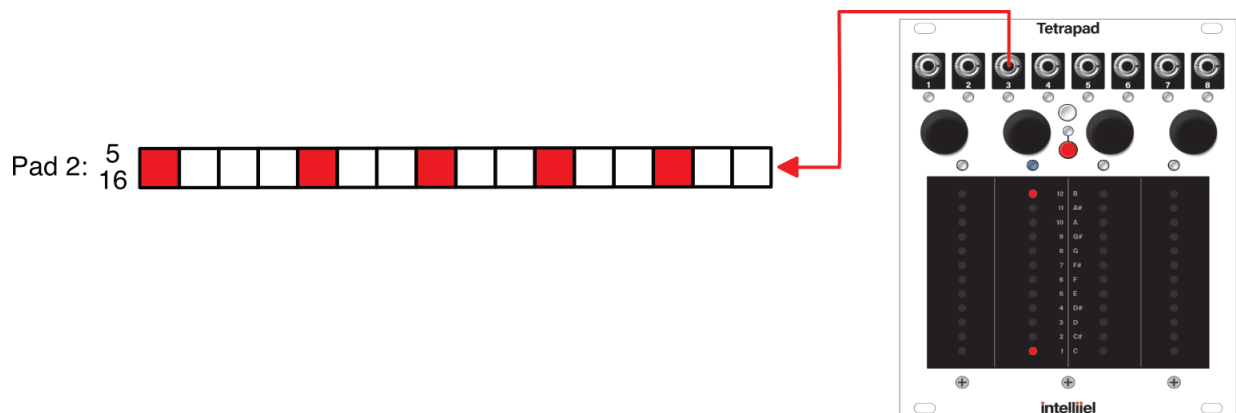

The rhythm will play for as long as you keep your finger on the pad.

5. If you wish to latch the rhythm so that it plays continuously, press the Pad's encoder.
6. As the rhythm plays, rotate the encoder to change the number of gates (or press-rotate the encoder to change the pattern length).

Your changes occur in real time, altering the euclidean rhythm and creating movement in your rhythms.

NOTE: You can control the euclidean parameters remotely by assigning Tête's X, Y or Z CV inputs to the number of euclidean pulses (gates), steps (length) or rotation as discussed in [CV Setup: Input X, Y and Z \(Combo Mode\)](#). To view the post-CV values, press Tetrapad's red SHIFT button to enter Shift View. In Shift View, all externally modulated euclidean parameters display inverted text and show the post-CV value (as opposed to the normal, unshifted view, which always displays the pre-CV value).

Creating & Rotating Syncopated Patterns

Assigning two or more pads to the Euclidean function and patching them to different sound sources results in interesting musically syncopated patterns.

In the following example, we've set Pad 1 to a 4/16 (four on the floor) pattern and Pad 2 to a syncopated 5/16 pattern (five gates spaced as evenly as possible across the 16 steps). Combined, they create the syncopated pattern shown on the bottom.

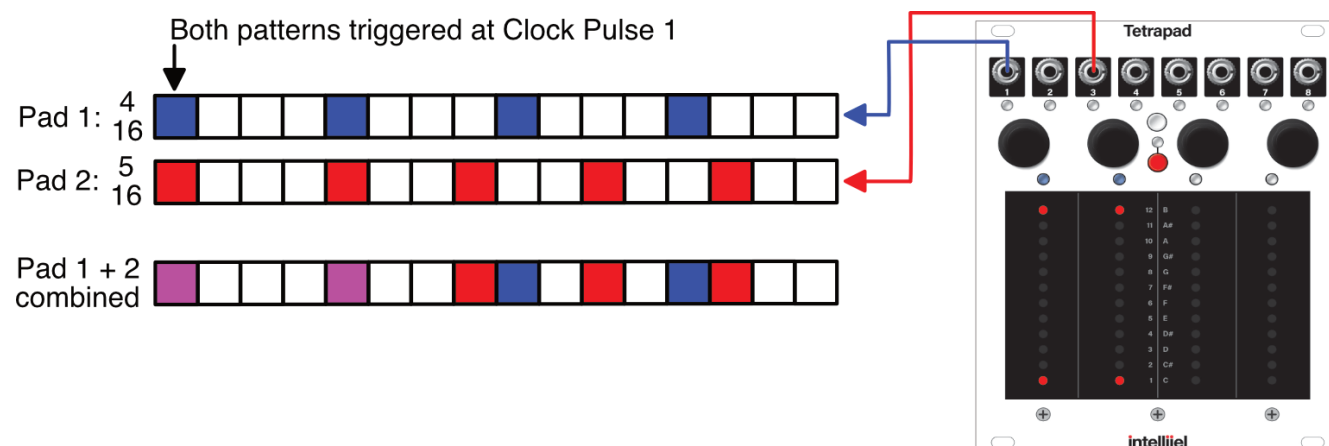

Without changing any of the actual euclidean parameters, you can then “rotate” one of the patterns, so that the two patterns are offset. This is done simply by tapping one of the pads to reset it. In the following example, we've tapped Pad 2 exactly one step after Pad 1, resulting in a syncopated pattern with an entirely different feel than the one in which both patterns started on Beat 1:

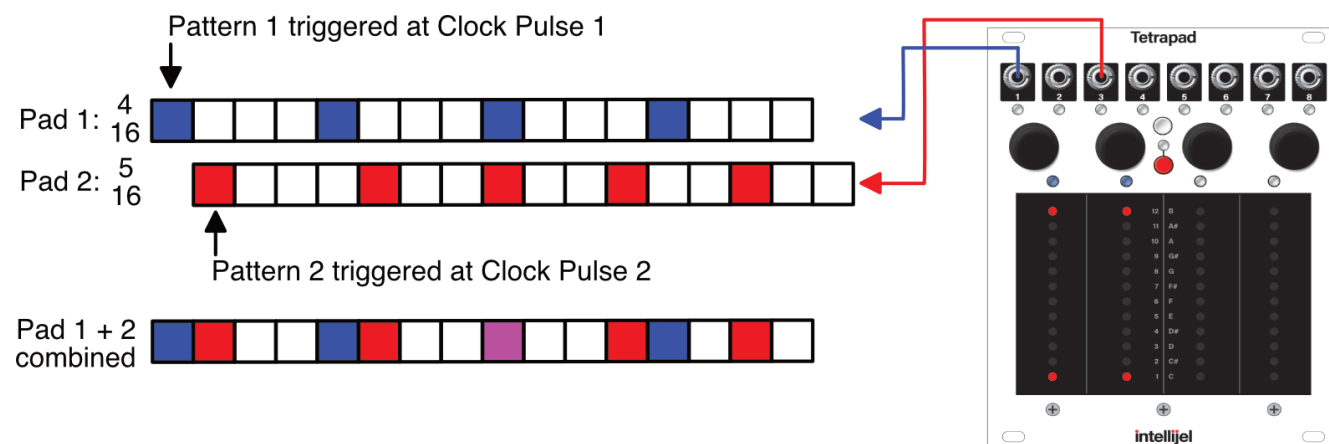

Using Euclidean Pads as Simple Drum Pads

If you'd prefer to use a pad as a simple 1-shot drum trigger (rather than triggering a euclidean sequence), you can do this by setting the euclidean sequence length to zero. Specifically:

1. Press & Rotate (counterclockwise) a Euclidean Pad's encoder to set the pattern length (denominator) to zero. The pad icon changes to show a single drum pad, rather than a set of euclidean parameters.

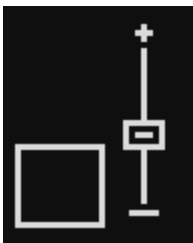

2. Tap a pad to generate a single gate from the pad's left output jack.

The gate remains high for as long as your finger is on the pad.

3. Move a finger up and down the pad to generate an additional position-sensitive voltage from the pad's right (even numbered) output.

The output's Status LED glows green to represent the presence of a position-based CV signal, while the brightness of the LED indicates its absolute value.

The vertical position's CV voltage can be scaled and/or quantized as discussed previously, making it useful for pitch-based control as well as general modulation duties.

If you set multiple pads to the Euclidean function; assign each of them a length of zero beats; and patch each pad's left output to a different drum module, then Tetrapad acts as a four-pad finger drumming surface (with vertical positioning of each pad being sent to control the parameters of your choice).

Slew Between Vertical Output Voltages

When you touch a pad at various heights, the output voltage normally jumps to the touched voltage instantly. However, you can have Tête slew between voltage changes, at a user-determined rate.

1. Hold down the red SHIFT button and rotate the pad's encoder to set its slew rate.

Clockwise turns increase the time it takes to move from one vertical value to another (up to a maximum of about a minute to move between min/max levels). Counterclockwise turns decrease the amount of time it takes to move from one value to another (down to “instantaneous”).

Slew times are indicated by a red Pad Status LED above the fader — with an LED glowing increasingly brighter as the slew gets longer.

Additionally, when a Euclidean pad is slewed and Tête is in SHIFT view (SHIFT LED is red), then a small “S” appears to the right of the Euclidean icon on Tête's display.

NOTE: Unlike Notes Mode or Voltages Mode, any slew applied to a pad in Combo Mode gets added before any CV-able Offsets/Level changes or voltage quantization.

Quantizing Vertical Output Voltages

You can quantize the vertical position voltage to generate note values that conform to the scale chosen in the Mode Setup Menu. This lets you use Euclidean/Drum mode to create melodic sequences that evolve in real-time as you touch the pads at varying heights. To do so:

1. Press Tetrapad's red SHIFT button to display Shift View. The red Shift View LED will light.
2. Press a pad's encoder to toggle vertical output quantization on/off.

When the vertical position output is quantized, its right Output Status LED turns blue, indicating the jack contains pitched voltages. In addition, a small “Q” appears to the right of the Euclidean icon on Tête's display.

3. On Tête, press the **SETUP MODE** button to display the Mode SETUP Menu.
4. Turn Tête's encoder to select the **Scale** and **Scale Root** options, and set them to the desired values as discussed in [Combo Mode SETUP Menu](#).
5. Press the **SETUP MODE** button again to exit the Mode SETUP Menu and return Tête to its default display.

Touching a pad at various heights will not generate note values from the pad's right output that conform to the chosen scale.

NOTE: Unlike Notes Mode or Voltages Mode, any quantization applied to a pad in Combo Mode happens after any CV-able Offsets/Level changes or slewing.

Combo Mode: Switches

CLK INPUT
Clock input for syncing Tête's sequencer, looper and other clock based functions to an external clock.

TRIG / RESET INPUTS
These inputs are assignable in the CV Setup menu, which is accessed by pressing the CV button.

X / Y / Z INPUTS
The destination for each input is assignable in the CV Setup menu, which is accessed by pressing the CV button.

Use the built-in attenuverters to scale the incoming CV as needed.

SCREEN
Displays relevant parameters and menus for operating Tête and Tetrapad in Combo Mode.

BUTTONS

- SETUP**
Press to toggle between the Mode SETUP Menu on & off.
Long-press to view the MODE Select Menu.
- CV**
Press to assign CV to Tête's inputs & outputs.
Long-press to save, load and manage presets.

ENCODER
Sets various parameter values (see documentation)

TEMPO
Long-press to set clock options.
Tap to set an internal tempo (determined by time between taps).

LOOPY
Press to toggle Loopy Mode on and off.
Hold for momentary Loopy Mode.

PLAY
Press to play/pause.
Long-press resets to beginning.

REC
Press to start/stop recording
Press to overdub (punch).
Long-press erases recording.

COMBO MODE (SWITCHES)

Visual indication of output voltage:

- Switch is in the OFF state**
0V is sent from the corresponding out.
- Switch is in the ON state**
+5V is sent from the corresponding out.

WHITE: Press to enter/exit Pad Assignment Mode. In Pad Assignment mode, turn the Encoder to select a Pad Type (as indicated on Tête's screen & the animated Pad display).

RED (SHIFT): Hold while pressing the encoder to set switch type (Momentary vs. Toggle) independently for the two switches.

Turn Latch Mode On/Off for BOTH switches

Changes whether the two switches behave as momentary switches or latched switches.

Turn Latch Mode On/Off for INDIVIDUAL switches

Allows you to assign one switch as a toggle and the other as a momentary. Repeat to switch the assignments.

- Both Switches = Momentary Type**
A switch stays on (5V) only as long as your finger is in contact with the switch.
- Both Switches = Toggle Type**
A switch stays on (5V) until touched again to turn it off (0V).
- One Switch is Momentary**
 One Switch is Toggle

Pad Assignment Indicator:
Two dimly lit four-LED regions show the top & bottom switches.

In Use:
Pad splits into upper and lower switches, indicated by the two dimly lit regions.

Touch top switch to send +5V to pad's left out. Touch the bottom switch to send +5V to pad's right out.

Latched switches stay on when touched, requiring they be touched again to turn off.

Unlatched switches act as momentary switches; staying on only as long as your finger rests on the switch.

Animation when assigning Switches to a Pad

When designated as a switch, a single pad becomes two independent switches — one on the top half of the pad (whose value appears at the pad’s left output); and one on the bottom half of the pad (whose value appears at the pad’s right output). The two switches can be configured to act either as latched toggle switches or as momentary switches.

Assigning Switch Functionality To A Pad

To assign Switch functionality to one of Tetrapad’s four pads:

1. Put Tête into Combo Mode, as described in [Entering Combo Mode](#), earlier.
2. Press the white EDIT button on Tetrapad to enable pad assignment.
Tête’s screen will invert, and the Level LEDs embedded beneath each pad will play an animation, indicating the function currently assigned to each pad.
3. Decide which of the four pads you want to make a switch, and rotate its encoder until the switch graphic is displayed.

On Tête, the graphic for a switch looks like this:

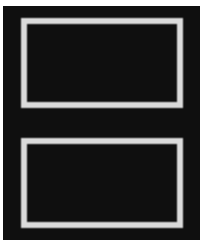

On Tetrapad, the pad animation for a switch looks like this:

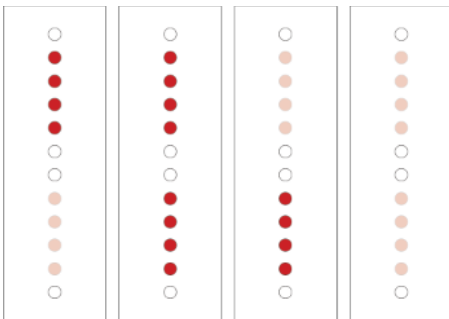

4. Press Tetrapad’s white EDIT button to exit pad assignment, and the assigned pad now works as a pair of switches.

Two four-LED segments are lit on the assigned pad — one segment on the top; and one on the bottom — indicating that it will now function as a pair of switches.

Using Switches

1. Touch a switch to send +5V to the corresponding Out jack.

Each pad is divided into two switches — one assigned to the top half of a pad, and the other assigned to the bottom.

The top switch controls the pad's left (odd numbered) output. The bottom switch controls the pad's right (even numbered) output.

Four LEDs light beneath the surface of the pad indicating which switch is currently active. When a switch is "on," the four switch indicator LEDs light brightly. When off, the indicator LEDs glow dimly. On the Tête screen, switched states appear as follows:

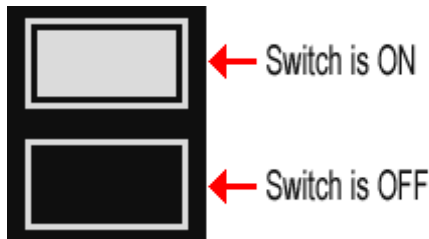

2. Press the pad's encoder to change whether the two switches on the corresponding pad act as momentary switches or toggle switches.
 - **Toggle Switch:** stays on until you press it again to turn it off.
 - **Momentary Switch:** Stays on only as long as your finger is on the switch. Removing your finger automatically turns the switch back off.

In both cases, the Output Status LEDs and Tête screen graphics indicate whether the switch is currently on (+5V = lit) or off (0V = off).

NOTE: You can make one switch momentary and the other a toggle by holding the red SHIFT button while pushing the encoder. Doing this repeatedly changes whether the top or bottom switch is defined as a toggle switch. When the two switch types are different, the Pad Status LED half-lights in blue.



Combo Mode: LFO

CLK INPUT
Clock input for syncing Tête's sequencer, looper and other clock based functions to an external clock.

TRIG / RESET INPUTS
These inputs are assignable in the CV Setup menu, which is accessed by pressing the CV button.

X / Y / Z INPUTS
The destination for each input is assignable in the CV Setup menu, which is accessed by pressing the CV button.

Use the built-in attenuverters to scale the incoming CV as needed.

SCREEN
Displays relevant parameters and menus for operating Tête and Tetrapad in Combo Mode.

BUTTONS

- Press to toggle between the Mode SETUP Menu on & off.
- Press to assign CV to Tête's inputs & outputs. Long-press to save, load and manage presets.

ENCODER
Sets various parameter values (see documentation)

TEMPO
Long-press to set clock options. Tap to set an internal tempo (determined by time between taps).

LOOPY
Press to toggle Loopy Mode on and off. Hold for momentary Loopy Mode.

PLAY
Press to play/pause. Long-press resets to beginning.

REC
Press to start/stop recording. Press to overdub (punch). Long-press erases recording.

COMBO MODE (LFO)

Left Pad = LFO Output
Right Pad = Inverse LFO Output
Both blink in time with LFO:

- Red = negative voltage
- Green = positive voltage
- ● Red+Green = bipolar

Brightness = higher absolute voltage

WHITE: Press to enter/exit Pad Assignment Mode.

RED (SHIFT): Press to toggle Shift View

- NORMAL View**
Rotating encoder selects LFO waveform. Pushing encoder locks rate.
- SHIFT View**
Rotating encoder attenuates LFO output. Pushing encoder cycles through six states: bipolar; unipolar (+); unipolar (-); and then quantized versions of those polarities.

NORMAL view:
 Turn to select LFO waveform, cycling through Sine > Tri > Saw > Ramp > Square > Random.

NORMAL view:
 Push while turning to morph between basic LFO waveforms.

SHIFT view:
 Sets maximum amplitude of LFO pad output (from 1V - 5V in 1V increments).

NORMAL view:
 Push to turn on/off the LFO Rate Lock.

SHIFT view:
 Push to cycle through six LFO states:
Un-Quantized: bipolar; unipolar (+); unipolar (-);
Then Quantized: bipolar; unipolar (+); unipolar (-);

Rate Lock Status:

- Unlocked** - LFO rate (or mult/div if clocked) changes with vertical pad position.
- Locked** - LFO rate is locked, but pressure is used to temporarily increase (upper part of pad) or decrease (lower pad) the LFO rate.

Pad Assignment Indicator:
An LFO initially displays three dimly lit LEDs at the pad's center, but updates to show touched position.

In Use:

-
-
-
-
-
-
-
-
-
-

Vertical position sets LFO rate (or multiplier/divider if clocked). LFO is sent to the left out, and inverted LFO is sent to the right output.

If locked, pressure changes rate. Pressing harder above center progressively increases frequency. Pressing harder below center decreases frequency. The higher or lower you press on the pad, the greater the effect. Stop pressing to return LFO to the locked rate (without resetting its phase).

Animation when assigning LFO to a Pad

When configured as an LFO, a single pad becomes a performance controller for a built-in Low Frequency Oscillator (LFO). The LFO output appears on the pad's left output jack, while an inverted version of the LFO is sent to the right output jack. Using a combination of the pad itself, plus the SHIFT button and encoders, you can set the LFO rate, waveshape, polarity, level, quantization, and other LFO attributes and control them in real time.

Assigning LFO Functionality To A Pad

To assign LFO functionality to one of Tetrapad's four pads:

1. Put Tête into Combo Mode, as described in [Entering Combo Mode](#), earlier.
2. Press the white EDIT button on Tetrapad to enable pad assignment.

Tête's screen will invert, and the Level LEDs embedded beneath each pad will play an animation, indicating the function currently assigned to each pad.

3. Decide which of the four pads you want to make an LFO, and rotate its encoder until the LFO graphic is displayed.

On Tête, the LFO graphic is dynamic — displaying both waveshape and LFO frequency:



On Tetrapad, the pad animation for an LFO looks like this:

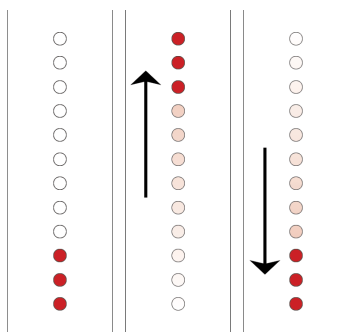

4. Press Tetrapad's white EDIT button to exit pad assignment, and the assigned pad now works as an LFO.

A grouping of three LEDs are lit on the assigned pad, indicating that it will now function as an LFO.

Using an LFO (Overview)

When a pad is designated as an LFO, its left (odd numbered) output transmits an LFO whose shape is set by turning the pad's encoder, and whose rate is determined by the vertical position of your finger on the pad. The pad's Output Status LED pulses in time with the LFO, and also indicates its polarity. Additionally, the pad's graphic on the Tête screen acts as a miniature oscilloscope, graphically showing the actual waveshape, frequency, and voltage range of the LFO. The pad's right (even numbered) output transmits an inverted version of the LFO.

LFO Basics

1. Connect the pad's left and right (odd- and even-numbered) output jacks to any modules you wish to modulate.

The pad's left (odd-numbered) jack outputs an unmodified LFO, while the pad's right (even-numbered) output jack transmits an inverted version of that same LFO.

2. Make sure Tetrapad is not in SHIFT View.

That is, if the Shift Status LED is currently lit red, push the red SHIFT button to turn it off.

3. Turn the pad's encoder to change its **waveshape**.

The pad continuously cycles through Sine > Triangle > Saw > Ramp > Square > Random.

The waveshapes are displayed graphically in the pad graphic on Tête's screen.

4. Push-turn a pad's encoder to **morph between waveshapes**.

If you push down on an encoder while turning it, Tête interpolates between waveshapes — gradually changing one waveshape into the next. There are twenty interpolated shapes between each basic waveshape and these, too, are displayed graphically on Tête's screen.

5. Touch the pad at various vertical positions to change the **LFO rate**.

Touching the pad in the middle produces a 1Hz (1 sec cycle) LFO. Touching at the bottom slows the rate to 16.6667mHz (60 sec Cycle); while touching at the very top outputs a 100 Hz (10ms cycle) LFO. Touching between these extremes scales the rate accordingly.

If you clock the LFO (via Tête's CLK input and with the Mode SETUP Menu's **LFO Sync** parameter turned "on"), then touching the pad in the middle outputs an LFO running at the same speed (1x) as the input clock. Touching the bottom of the pad slows the rate to 1/32 of the clock; while touching the top of the pad increases it to 32x.

The LFO rate is displayed graphically in the pad graphic on Tête's screen, as well as by the flashing Output Status LED.

NOTE: You can produce slower cycles by sending very slow clock pulses to Tête's CLK input. For example, a 5 BPM clock with a 1x multiplier would produce a 12 sec oscillation, but

touching the bottom of the pad would divide that clock by 32, resulting in a cycle nearly 6.5 minutes long. The maximum LFO rate will, however, always top out at 100Hz.

You can also assign Tête's CV inputs to further modify the LFO rate, as discussed in [CV Setup: Input X, Y and Z \(Combo Mode\)](#). Any modulation of LFO rate by CV or Pressure (discussed below) are summed with the existing, pad-determined LFO rate.

Locking the LFO Rate

You can lock a Pad's LFO rate, then use pressure to temporarily increase or decrease the rate — perfect for real time performance control. Specifically:

1. Make sure Tetrapad is not in SHIFT View.

That is, if the Shift Status LED is currently lit red, push the red SHIFT button to turn it off.

2. Touch the pad to set the desired LFO rate.
3. Press the encoder to lock the LFO rate at its current value.

The corresponding Pad Status LED turns blue, indicating the LFO rate is locked.

Lightly sliding your finger up/down the pad will no longer change the LFO rate, however applying pressure will change the rate. Specifically:

4. Touch (with pressure) anywhere above the center of the pad, and the LFO rate will temporarily increase accordingly.

Release your finger and the LFO rate returns to the locked value.

5. Touch (with pressure) anywhere below the center of a pad, and the locked LFO rate will temporarily decrease accordingly.

Release your finger and the LFO rate returns to the locked value.

6. To unlock an LFO, simply press the encoder again, turning off its blue Pad Status LED.

Attenuating the LFO Output

You can attenuate the output of an LFO from a maximum of 5V down to only 1V. To do so:

1. Put Tetrapad into SHIFT View.

That is, if the Shift Status LED is currently unlit, push the red SHIFT button to turn it on.

2. Turn the encoder to scale the output level of the LFO.
3. Turning it counterclockwise decreases the output voltage in 1V increments, down to a maximum absolute output value of 1V. Turning it clockwise increases the output voltage in 1V increments, up to a maximum absolute output value of 5V.

Unipolar, Bipolar and Quantized LFOs

Any LFO can be made bipolar (-5V to +5V, without attenuation); unipolar positive (0V to +5V, without attenuation); or unipolar negative (-5V to 0V, without attenuation). In addition, the LFO can be quantized according to the root and scale set in the [Combo Mode SETUP Menu](#).

To do so:

1. Put Tetrapad into SHIFT View.

That is, if the Shift Status LED is currently unlit, push the red SHIFT button to turn it on.

2. Push the encoder to cycle through the six options, as illustrated here.

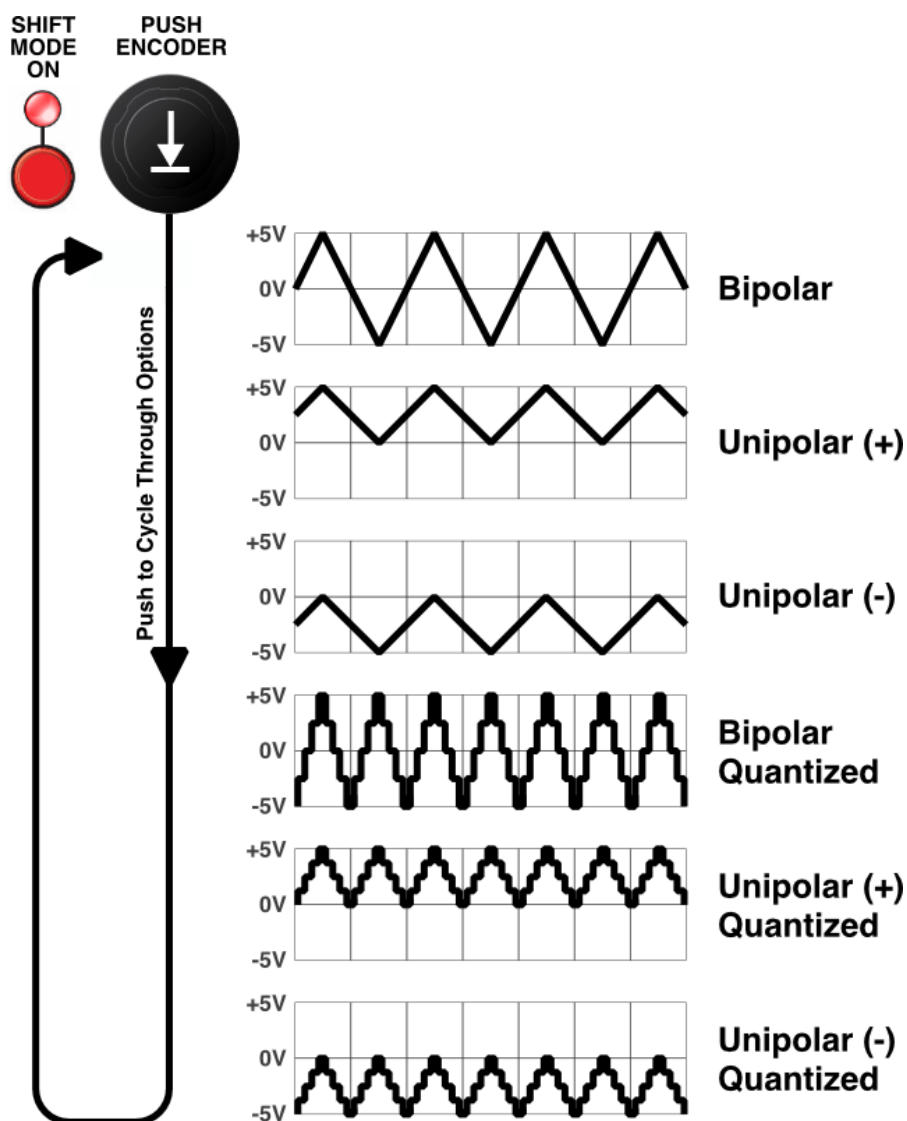

Combo Mode: Voltage Banks

CLK INPUT
Clock input for syncing Tête's sequencer, looper and other clock based functions to an external clock.

TRIG / RESET INPUTS
These inputs are assignable in the CV Setup menu, which is accessed by pressing the CV button.

X / Y / Z INPUTS
The destination for each input is assignable in the CV Setup menu, which is accessed by pressing the CV button.
Use the built-in attenuverters to scale the incoming CV as needed.

SCREEN
Displays relevant parameters and menus for operating Tête and Tetrapad in Combo Mode.

BUTTONS

- SETUP**
Press to toggle between the Mode SETUP Menu on & off.
Long-press to view the MODE Select Menu.
- CV**
Press to assign CV to Tête's inputs & outputs.
Long-press to save, load and manage presets.

ENCODER
Sets various parameter values (see documentation)

COMBO MODE (VOLTAGE BANKS)

SYNC
CV Out (Assignable)

A OUT
CV Out (Assignable)

B OUT
CV Out (Assignable)

Stored Voltage L
CV Out

Stored Voltage R
CV Out

Visual indication of output voltage:

- **Positive (unquantized) Voltage Level**
- **Negative (unquantized) Voltage Level**
- **Quantized Voltage Level**

Brightness of LED = higher absolute voltage.

WHITE: Press to enter/exit Pad Assignment Mode.

RED (SHIFT): Press to toggle Shift View

- **NORMAL View**
Press Encoder to toggle between left or right voltage, and turn to edit. SHIFT-press to randomize all.
- **SHIFT View**
Press Encoder to cycle through quantize options (L, R, LR, OFF).
Hold the SHIFT button and turn encoder to set the fader's slew rate.

In Normal (unshifted) view:

- Press Encoder to **toggle** between editing voltage for Left or Right output
- Turn to **set voltage** for the selected output.
- Hold SHIFT and press encoder to **randomize** all 8 voltages across all four banks.
- Hold SHIFT and turn to set the **slew rate** between voltage changes.

In SHIFT view:

- Cycles through quantized output options: L, R, LR, OFF

Pad Assignment Indicator:
A Voltages pad displays four lit LEDs conforming to the pad's four voltage banks.

In Use:
Each LED indicates one of the four voltage banks assigned to a pad.
Touching a voltage banks sends a pair of stored voltage's out the pad's Left and Right output jacks.

You can slew between voltages by holding the red SHIFT button and turning the encoder to set a slew rate. Or you can quantize voltages by pressing the Encoder in SHIFT view to toggle through the options.

Slew Rate
Brighter = more slew

Animation when assigning a Voltage Bank

Page 64

When configured as a Voltage Bank, a single pad gives you access to four pairs of stored voltages. Touching one of the four lit zones on a pad transmits one stored voltage from the pad's left, odd-numbered output, and a different voltage from its right, even-numbered output.

Assigning Voltage Bank Functionality To A Pad

To assign Voltage Bank functionality to one of Tetrapad's four pads:

1. Put Tête into Combo Mode, as described in [Entering Combo Mode](#), earlier.
2. Press the white EDIT button on Tetrapad to enable pad assignment.
Tête's screen will invert, and the Level LEDs embedded beneath each pad will play an animation, indicating the function currently assigned to each pad.
3. Decide which of the four pads you want to make a Voltage Bank, and rotate its encoder until the Voltage Bank graphic is displayed.

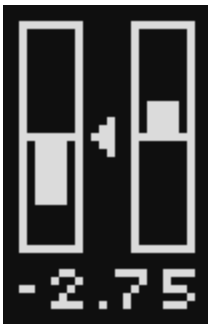

On Tetrapad, the pad animation displays four lit LEDs of rotating brightness.

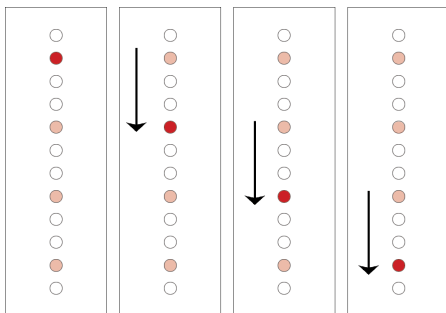

4. Press Tetrapad's white EDIT button to exit pad assignment, and the assigned pad now works as a Voltage Bank.

Four LEDs are lit on the assigned pad, indicating each of the four touchable voltage banks.

When configured as a Voltage Bank, a single pad stores 8 voltages — two for each bank, with one voltage appearing at the pad's Left output and the other at the pad's Right output. Using a combination of the pad itself, plus the SHIFT button and encoders, you can manually set voltage values, randomize them, slew between them or quantize their values to a chosen scale.

Using Voltage Banks

When you assign the Voltage Bank function to a pad, many of its parameters are indicated by the pad graphic on Tête's screen.

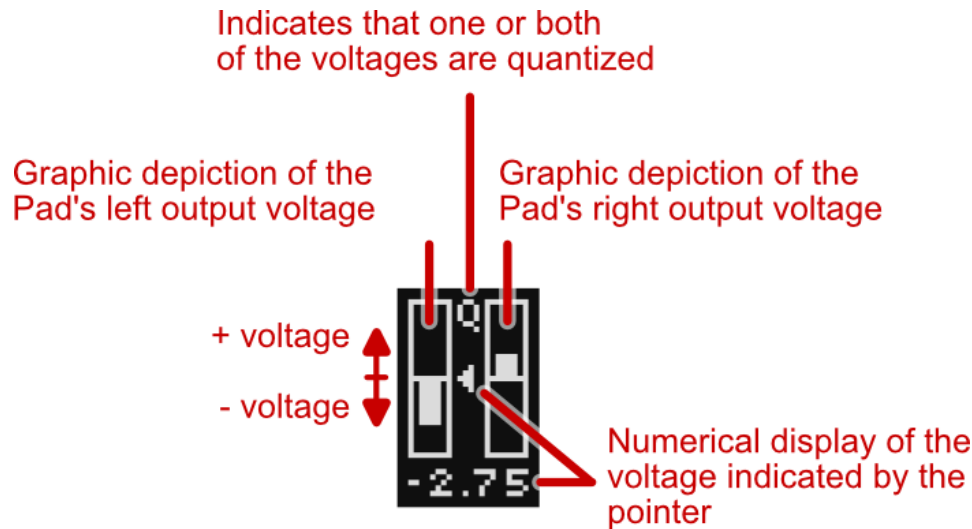

The left column graphically displays the voltage sent to the Pad's left output. Bars extending up from the center indicate positive voltages (with the relative height equalling the relative voltage). Bars extending down from the center indicate negative voltages. 0V is in the center of the column.

The numerical value of one output's voltage is seen beneath the columns. Switch between having it display the left output voltage or the right output voltage by pressing the Encoder — the pointer will point to the column (output) whose voltage is being numerically displayed.

If one or more output voltages are quantized to a note value (see below), then the little Q indicator appears at the top of the display.

Sending Voltages

1. Assign one or more pads to perform as Voltage Banks, as described above.
2. Connect the pad's left and right (odd- and even-numbered) output jacks to any modules you wish to modulate.
3. Press any of the pad's four voltage bank regions (each indicated by a lit LED) to send a pair of memorized, static voltages to the pad's left and right outputs.

Setting Voltages Manually

1. Make sure Tetrapad is not in SHIFT View.
That is, if the Shift Status LED is currently lit red, push the red SHIFT button to turn it off.
2. Press whichever of the pad's four voltage bank regions you wish to define.
3. Press the pad's encoder to toggle between setting the Left and Right output voltage.
The little indicator arrow between the two voltage display columns changes direction to indicate which voltage is being set.
4. Turn the pad's encoder to set the desired voltage level for the indicated output.

Setting Voltages Randomly

1. Hold down the red SHIFT button and press the pad's encoder.
Tête randomizes all eight voltages (4 voltage regions, each with a Left and Right output voltage).

Slewing Between Voltages

1. Hold down the red SHIFT button and rotate the pad's encoder to set its slew rate.
Clockwise turns increase the time it takes to change from one voltage to another (up to a maximum of about a minute to move between min/max changes). Counterclockwise turns decrease the amount of time it takes to move from one voltage to another (down to "instantaneous").
Slew times are indicated by a red Pad Status LED above the pad — with an LED glowing increasingly brighter as the slew gets longer.

NOTE: Unlike Notes Mode or Voltages Mode, any slew applied to a pad in Combo Mode gets added before any CV-able Offsets/Level changes or voltage quantization.

Quantizing Voltages

Voltages can be quantized to values that conform to a chosen scale. To do so:

1. Press Tetrapad's red SHIFT button to display Shift View.
The red Shift View LED will light.
2. Press a pad's encoder to cycle through the following quantization options:
Left output's voltages are quantized > Right output's voltages are quantized > Both outputs' voltages are quantized > Neither outputs' voltages are quantized.

When an output is quantized, its Output Status LED turns blue, indicating the jack contains pitched voltages. In addition, a small “Q” appears between the two voltage columns in Tête’s display if quantization is enabled on either output.

3. On Tête, press the **SETUP MODE** button to display the Mode SETUP Menu.
4. Turn Tête’s encoder to select the **Scale** and **Scale Root** options, and set them to the desired values as discussed in [Combo Mode SETUP Menu](#).
5. Press the **SETUP MODE** button again to exit the Mode SETUP Menu and return Tête to its default display.
6. Touch one of the four voltage banks on a pad, and the voltage on the selected output (left, right or both) will now output pitched values conforming to the selected Scale and Root.

NOTE: Unlike Notes Mode or Voltages Mode, any quantization applied to a pad in Combo Mode happens after any CV-able Offsets/Level changes or slewing.

PART FOUR:
NOTES MODE

NOTES MODE

CLK INPUT
Clock input for syncing Tête's sequencer, looper and other clock based functions to an external clock.

TRIG / RESET INPUTS
These inputs are assignable in the CV Setup menu, which is accessed by pressing the CV button.

**NOTES MODE
(COMMON FEATURES)**

Visual indication of output assignment and voltage:

- Outs 1-4: Indicate Note outputs
- Out 5: Position (any Pad)
(brightness = higher absolute voltage)
- Out 6: Pressure (any Pad)
(brightness = amount)
- Out 7: Trigger (any Pad)
- Out 8: Gate (any Pad)

X / Y / Z INPUTS
The destination for each input is assignable in the CV Setup menu, which is accessed by pressing the CV button. Use the built-in attenuverters to scale the incoming CV as needed.

SCREEN
Displays relevant parameters and menus for operating Tête and Tetrapad in Notes Mode.

BUTTONS

- **SETUP**
Press to toggle between the Mode SETUP Menu on & off.
Long-press to view the MODE Select Menu.
- **CV**
Press to assign CV to Tête's inputs & outputs.
Long-press to save, load and manage presets.

ENCODER
Sets various parameter values (see documentation)

TEMPO
Long-press to set clock options. Tap to set an internal tempo (determined by time between taps).

LOOPY
Press to toggle Loopy Mode on and off. Hold for momentary Loopy Mode.

PLAY
Press to play/pause. Long-press resets to beginning.

REC
Press to start/stop recording. Press to overdub (punch). Long-press erases recording.

PADS:
Notes Mode stores virtual 'keyboards' consisting of 4, 8, 12 or 16 virtual pads. Each virtual pad is like a separate key on a keyboard — each capable of sending different user-assignable note values to Tetrapad Outputs 1-4.

You can assign notes to virtual pads (keys) either manually, by scale, or by chord.

When configured as 8 virtual pads, each real pad is split into an upper zone and a lower zone, resulting in 8 "keys."

When configured as 12 pads, Tetrapad splits each physical pad into three zones, giving you access to twelve different "keys."

When set to 16 pads, Tetrapad splits each physical pad into four zones, resulting in 16 "keys."

The four push encoders and the Shift Button function differently depending on whether you assign notes manually, by scale, or by chord. See the individual discussions in the manual to learn how these encoders work within each of the various Note assignment methods.

Visual indication of octave:

- Higher octaves (brightness = oct height, up to +5 oct)
- Lower octaves (brightness = oct depth, down to -5 oct)

If you hold SHIFT and turn Encoder 1, the LED displays slew rate rather than octave. Brighter LED = longer slew time: ● ○ ● ●

Hold down SHIFT while turning any Encoder to set a global slew time between notes (portamento).

Notes Mode turns Tetrapad into either a 4, 8, 12, or 16-key keyboard, with each “key” capable of sending a different note to Outputs 1-4. This mode divides each of the four pads into one, two, three or four zones (user selectable). Touching any zone also outputs both a trigger and a gate signal, and pads respond to both position and pressure. Tête provides you with three different ways to define which zone sends which notes to which outputs:

- **By Scale:** Use Tetrapad’s encoders to auto-map notes to zones & outputs using the extensive built-in Scale Library (accessed via the Mode SETUP Menu), and assign a root note and starting octave to those scales. Diatonically shifted versions of the root scale appear at each of the four outputs and you can rotate these assignments using another encoder or one of Tête’s CV inputs. Assigning notes by scale enables you to quickly create little 4-, 8-, 12-, or 16-key ‘keyboards’ that conform to a particular scale. For more information, see [Set Notes by Scale](#).
- **By Chord:** Use Tetrapad’s encoders to auto-map notes to zones & outputs using the extensive built-in Chord Library, and assign a root note and starting octave to those chords. Four notes within each chord appear at the four outputs. In addition, you can rotate chords and perform inversions using Tetrapad’s encoders or Tête’s CV inputs. Assigning notes by chord enables you to create 1-finger chord progression across Tetrapad’s 4-, 8-, 12-, or 16-key ‘keyboard’. For more information, see [Set Notes by Chord](#).
- **Manually:** Use Tetrapad’s encoders to manually map each zone to a specific note for each output. Manual note assignment is for people who want direct control over the pitch of every key and output, or who don’t wish to be constrained by traditional scales or chords. For more information, see [Set Notes Manually](#).

You can set a slew time (portamento) between notes, and you can vary this time using one of Tête’s CV inputs.

Tête can also record and play back notes in real-time (using its built-in [Looper](#)) or in step-time (using its built-in [Sequencer](#)).

Entering Notes Mode

To enter Notes Mode:

1. Long-press (>1 sec) the **SETUP MODE** button to display the MODE Select Menu.
2. Rotate the screen encoder to highlight **Notes**, then press the encoder to select it.

The Notes Mode screen appears and Tetrapad switches to Notes Mode.



Generic Notes Mode screen when [assigning notes w/Scale](#).



Generic Notes Mode screen when [assigning notes w/Chord](#).



Generic Notes Mode screen when [assigning notes Manually](#).

Setting the Number of Virtual Keys

One of the first things you'll wish to do in Notes mode is to configure Tetrapad's 'keyboard' to play either 4, 8, 12, or 16 pads, or virtual 'keys'. To do so:

1. Press Tête's **SETUP MODE** button to display the Mode SETUP Menu.
2. Rotate Tête's screen encoder to select the **Pads** option, then press the encoder.
3. Rotate the encoder to select between **4, 8, 12, and 16** pads, then press the encoder to apply your selection.

Tetrapad will divide each pad into either 1, 2, 3 or 4 zones, giving you either a 4, 8, 12 or 16-note 'keyboard.' The LEDs beneath each pad light dimly to show the location of each 'key.'

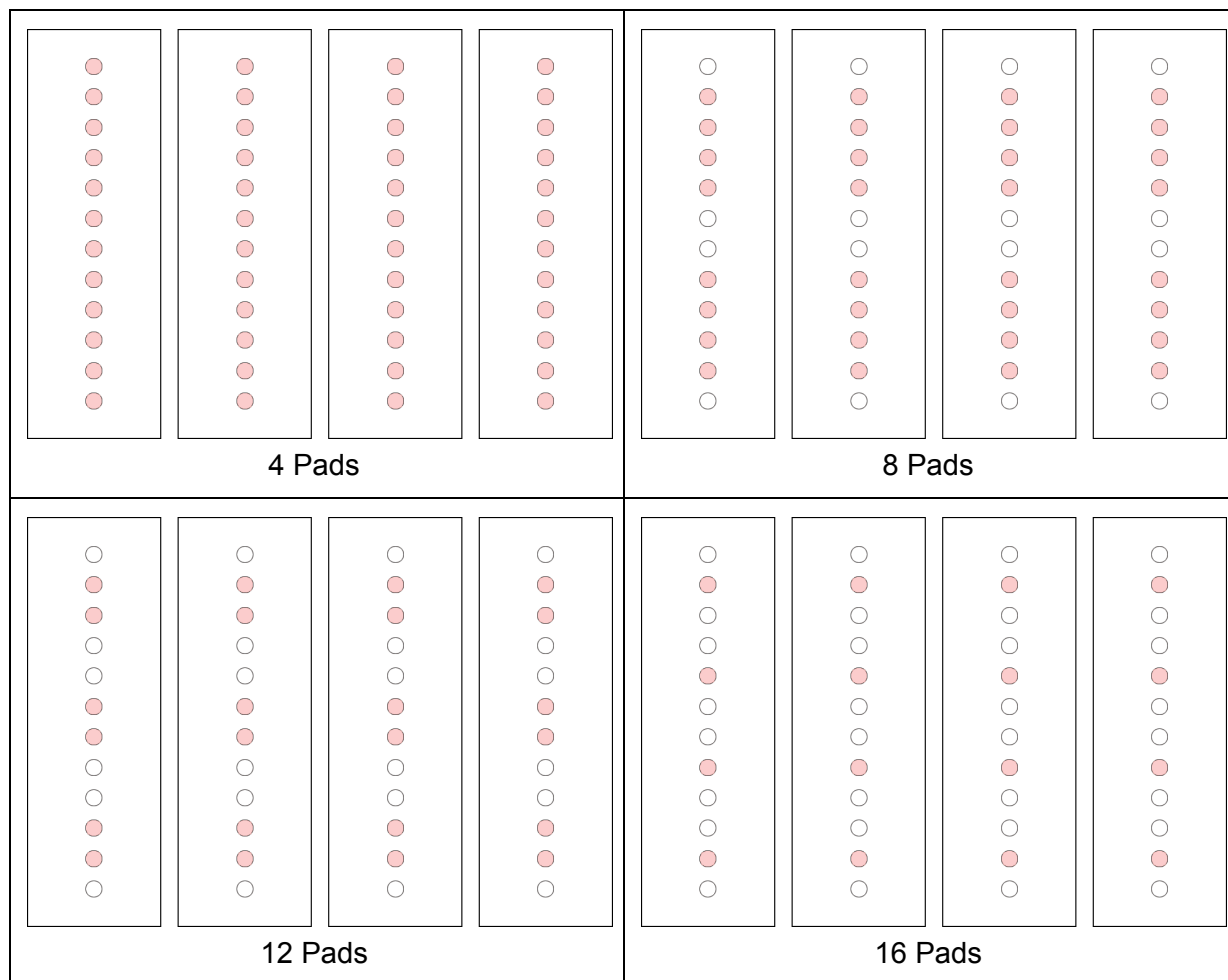

Tuning Mode

Notes Mode features a special Tuning Mode that instantly re-configures all four of Tetrapad's note outputs (1 - 4) to send 0V, and its TRIG and GATE outputs (7 - 8) to send high gate signals. This lets you use Tetrapad as a quick tuning reference for any connected oscillators.

1. Long-press (>1 sec) Tetrapad's white EDIT button.

The center LED turns blue (indicating Tuning Mode) and Tête's screen indicates "Tuning Mode."

In this mode, Tetrapad outputs 1-4 transmit 0V, and outputs 7-8 transmit high gate signals.

2. When you're done tuning your oscillators, repeat the process (i.e. long-press (>1 sec) the white EDIT button).

Tetrapad operation returns to normal.

Choosing a Note Assignment Method

After you tell Tetrapad how many keys you want included on its 'keyboard,' you need to next tell it how you wish to define note values for each 'key.' To do so:

1. If you're not still looking at the Mode SETUP Menu, press the **SETUP MODE** button to display it.
2. Rotate Tête's screen encoder to select the **Assign** option, then press the encoder.
3. Rotate the encoder to select between **w/Scale**, **w/Chords**, and **Manually**.

Tetrapad will then assign note values to each key as discussed on the following pages.

Set Notes by Scale

This mode uses Tetrapad's encoders to auto-map notes to its virtual 'keys' & output jacks using the built-in Scale Library (accessed via the Mode SETUP Menu). You can also assign a root note and starting octave to those scales. Diatonically shifted versions of the root scale appear at each of the four outputs. Specifically, the notes appearing at Out 2 are diatonically shifted +2; the notes appearing at Out 3 are diatonically shifted by +4; and the notes appearing at Out 4 are diatonically shifted by +6. You can rotate these assignments using Encoder #3, or one of Tête's assignable CV inputs.

Assigning notes by scale enables you to quickly create little 4-, 8-, 12-, or 16-key 'keyboards' that conform to a particular scale.

When you tell Tetrapad to assign notes **w/Scale**, Tête's screen shows the following information:

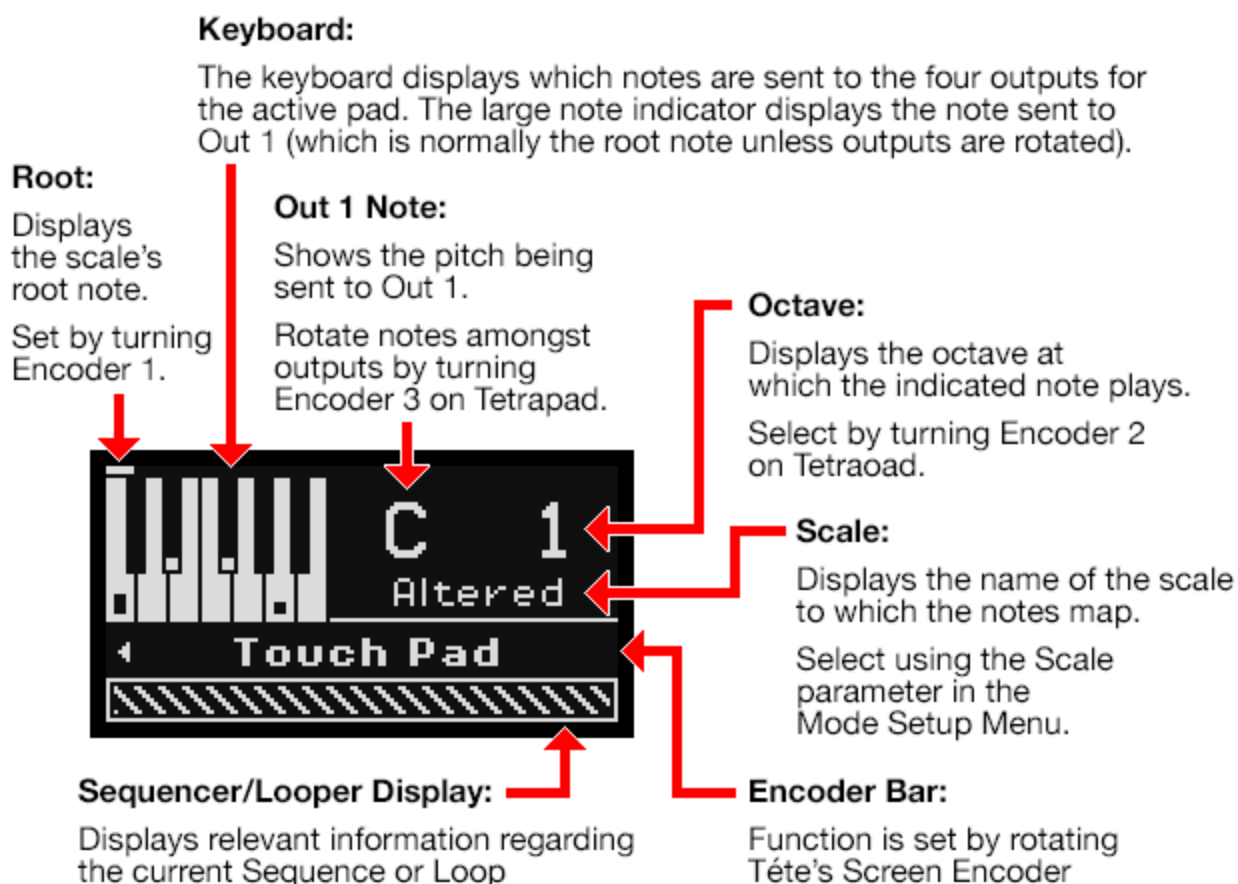

The following illustration shows how Tetrapad's push-encoders, SHIFT button, and Outputs function when assigning notes by Scale. The other functions (common across all Notes Modes) are also shown for convenience.

CLK INPUT
Clock input for syncing Tête's sequencer, looper and other clock based functions to an external clock.

TRIG / RESET INPUTS
These inputs are assignable in the CV Setup menu, which is accessed by pressing the CV button.

X / Y / Z INPUTS
The destination for each input is assignable in the CV Setup menu, which is accessed by pressing the CV button. Use the built-in attenuverters to scale the incoming CV as needed.

SCREEN
Displays relevant parameters and menus for operating Tête and Tetrapad in Notes Mode.

BUTTONS

- SETUP** Press to toggle between the Mode SETUP Menu on & off.
- CV** Long-press to view the MODE Select Menu. Press to assign CV to Tête's inputs & outputs. Long-press to save, load and manage presets.

ENCODER
Sets various parameter values (see documentation)

TEMPO
Long-press to set clock options. Tap to set an internal tempo (determined by time between taps).

LOOPY
Press to toggle Loopy Mode on and off. Hold for momentary Loopy Mode.

PLAY
Press to play/pause. Long-press resets to beginning.

REC
Press to start/stop recording. Press to overdub (punch). Long-press erases recording.

NOTES MODE (SET VIA SCALE)

Visual indication of output assignment and voltage:

- Outs 1-4: Indicate Note outputs
- Out 5: Position (any Pad) (brightness = higher absolute voltage)
- Out 6: Pressure (any Pad) (brightness = amount)
- Out 7: Trigger (any Pad)
- Out 8: Gate (any Pad)

Encoder	Function	Modifier
1	Set Root Note *	
2	Set Octave	
3	Rotate Outputs	
4	Invert Scale	
1	Reset Root to C0	
2	Reset Octave to 0	
3	Reset Rotation	
4	Reset Inversion	
1	Set Octave	
2	Set Octave	
3	Rotate Outputs	
4	Invert Scale	
1	Set Slew for all Pads	(Hold SHIFT & Turn any encoder to set the slew rate for all pads)
2	Set Slew Limits	(Hold SHIFT & Push+Turn any encoder to set minimum (turn CCW) and max (CW) slew limits for CV)

* Scale Type is set in Mode SETUP Menu

Visual indication of octave:

- Higher octaves (brightness = oct height, up to +5 oct)
- Lower octaves (brightness = oct depth, down to -5 oct)

If you hold SHIFT and turn Encoder 1, the LED displays slew rate rather than octave. Brighter LED = longer slew time: ○●●●●●●●

Hold down SHIFT while turning any Encoder to set a global slew time between notes (portamento).

Hold down SHIFT while press-turning any Encoder to limit the range of CV-able slew.

PADS:

Notes Mode stores virtual 'keyboards' consisting of 4, 8, 12 or 16 virtual pads. Each virtual pad is like a separate key on a keyboard — each capable of sending different user-assignable note values to Tetrapad Outputs 1-4. You can assign notes to virtual pads (keys) either manually, by scale, or by chord.

When configured as 8 virtual pads, each real pad is split into an upper zone and a lower zone, resulting in 8 "keys."

When configured as 12 pads, Tetrapad splits each physical pad into three zones, giving you access to twelve different "keys."

When set to 16 pads, Tetrapad splits each physical pad into four zones, resulting in 16 "keys."

Assigning Notes to the Tetrapad ‘Keyboard’ w/Scale

The following steps discuss using the Scale feature to assign note values to Tetrapad “keys” and outputs:

1. Select whether you want Tetrapad split into 4, 8, 12 or 16 virtual ‘keys’ using the Mode SETUP Menu (accessed by short-pressing the **SETUP MODE** button as described in [Setting the Number of Virtual Keys](#)).
2. In the same Mode SETUP Menu, tell Tetrapad to assign notes **w/Scale**, as described in [Choosing a Note Assignment Method](#).
3. With the Mode SETUP Menu still visible, rotate Tête’s Encoder to select the **Scale** option, press it, then turn it to select the desired scale (See [Notes Mode SETUP Menu](#) for a list of available scales).

Selecting a scale automatically assigns the notes within that scale to different “keys” on Tetrapad.

Furthermore, selecting a scale assigns notes to each of the three additional pitch outputs, but rotates their values diatonically. This means the notes appearing at Out 2 are diatonically shifted +2; the notes appearing at Out 3 are diatonically shifted by +4; and the notes appearing at Out 4 are diatonically shifted by +6.

NOTE: When using Tetrapad’s ‘keyboard,’ you can see the actual value of the notes on both the Tetrapad surface and in the Tête display. Specifically, on Tetrapad, each time you touch a ‘key,’ the four pads indicate (via a single bright Level LED on each pad) what note value is being sent to the corresponding output (using the Level Labels in the middle of the pad to identify the note name). On the Tête screen, each time you touch a Tetrapad ‘key,’ the miniature keyboard graphic shows which four notes are being sent to which four outputs, with the “bold” note showing the value sent to Out 1, and the other four values rotated through outputs 2, 3, and 4 (discussed in Step 5, below).

4. Short-press (<1 sec) the **SETUP MODE** button to exit the Mode SETUP Menu.
5. Turn Encoder 1 to set the root note of the scale.

On Tetrapad, the root note is indicated by the single brightest Level LED beneath the first pad (unless you’ve rotated the outputs, described later, in which case it’s the Level LED beneath the Pad corresponding to the output with the brightest blue Output Status LED).

NOTE: Pressing Encoder 1 resets the root note to C0.

6. Turn Encoder 2 to change the keyboard’s octave.

Turn clockwise to increase the octave, and counterclockwise to lower the octave.

Octave numbers are displayed on Tête’s screen, and on Tetrapad itself. Specifically, on the Tetrapad, octaves above the default zero-range cause the Pad Status LED to glow green. With

each subsequent octave increase, the LED will brighten. Octave settings below the default zero-range cause the Pad Status LED to glow red. With each subsequent octave decrease, the LED will brighten. Tetrapad gives you a 10 octave range.

NOTE: Pressing Encoder 2 resets the keyboard to the zero octave.

5. Turn Encoder 3 to rotate the output assignments.

With each clockwise turn, the output assignments shift to the right by 1. So if you turn Encoder 3 one turn clockwise, the unshifted scale will appear at Out 2 (rather than Out 1); the +2 scale moves to Out 3; the +4 scale moves to Out 4; and the +6 scale moves to Out 1.

On Tetrapad, the brightest of the four blue Output Status LEDs indicates which output is currently assigned to the unshifted scale. On Tête, the boldest note indicator reflects which output is currently assigned to the unshifted scale.

NOTE: Pressing Encoder 3 removes any rotation, placing the root note back on Out 1.

6. Turn Encoder 4 to invert the outputs.

Clockwise rotation inverts the 4-notes upward; counterclockwise rotation inverts them downward. For example, one CW turn transposes Out 1 up one octave; a second CW turn transposes Out 2 up one octave, and so on. Similarly, one CCW turn transposes Out 4 down one octave; etc.

NOTE: Pressing Encoder 4 removes any inversion.

Playing the Keyboard

1. Touch any of the 4, 8, 12 or 16 keys (as chosen in [Setting the Number of Virtual Keys](#)) to send the assigned notes to Output 1.

In addition, Tetrapad sends diatonically shifted versions of the scale to each of the three remaining outputs. Specifically, Out 2 is diatonically shifted +2; Out 3 is diatonically shifted by +4; and the notes appearing at Out 4 are diatonically shifted by +6.

CV representing the vertical position of your tap on the key is sent to Out 5. CV representing the pressure you apply to any key is sent to Out 6. A trigger signal is sent to Out 7, and a Gate is sent to Out 8.

You can use Encoder 3 to rotate the output assignments, and Encoder 4 to invert them (as discussed previously).

NOTE: You can also control rotation and inversion via CV by assigning the function(s) to any of Tête's three CV inputs, as discussed in [CV Setup Menu](#).

The following flow diagram illustrates these basic note setting and performance instructions graphically:

(1) Notes mode divides Tetrapad into either a 4, 8, 12 or 16-note 'keyboard.'
(This example shows it configured as an 8-note keyboard).

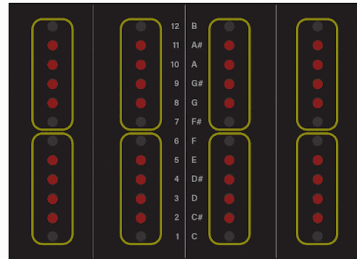

(2) Touching one of the virtual keys lights it beneath your finger. The LEDs remain dimly lit when you lift your finger, indicating which key is selected.

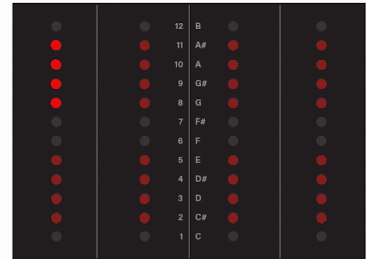

(3) This sends a pitch from within a chosen scale to Out 1, while sending rotated scales to Outs 2-4 (where Out 2 is a diatonic +2 rotation of Out 1; Out 3 is a +4 rotation; and Out 4 a +6 rotation). Position, pressure, trigger and gate appear at Outs 5-8.

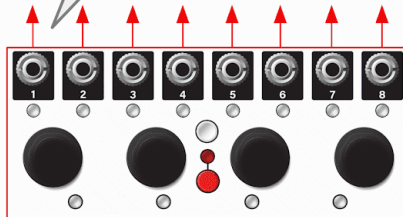

(4) The four encoders perform the following functions:
 1: turn: Sets root note of scale.
 press: Resets root note to C0.
 2: turn: Sets octave
 press: Resets octave
 3: turn: Rotates output assignment.
 press: Clears rotation
 4: rotate: Inverts 'chord' being set to Outs 1-4.
 press: Clears inversion

Slew Between Notes

Tetrapad also gives you the ability to slew between notes. To do so, press the red SHIFT button and continue holding it while turning Encoder 1.

Clockwise turns increase the time it takes to move from one note to another (up to approximately a 4 second glide). Counterclockwise turns decrease the amount of time (down to “instantaneous”).

Slew times are indicated by a red Pad Status LED above each fader — with an LED glowing increasingly brighter as the slew gets longer.

Slew time is a global setting within Keyboard Mode, meaning the rate of change affects all notes equally.

NOTE: CV control over slew time is available in Tête’s [CV Setup Menu](#). You can limit the extent to which CV can control Slew by holding down the red SHIFT button while pressing & turning any of the four Encoders. Counterclockwise turns set the lower CV-able Slew limit, while clockwise turns set the upper CV-able Slew limit.

Set Notes by Chord

This mode uses Tetrapad's encoders to auto-map notes to its virtual 'keys' & output jacks using a built-in Chord Library. You can also assign a root note and starting octave to those chords. Four notes within each chord appear at the four outputs. In addition, you can rotate chords and perform inversions using Tetrapad's encoders or Tête's CV inputs. Assigning notes by chord enables you to create 1-finger chord progression across Tetrapad's 4-, 8-, 12-, or 16-key 'keyboard'.

When you tell Tetrapad to assign notes **w/Chords**, Tête's screen shows the following information:

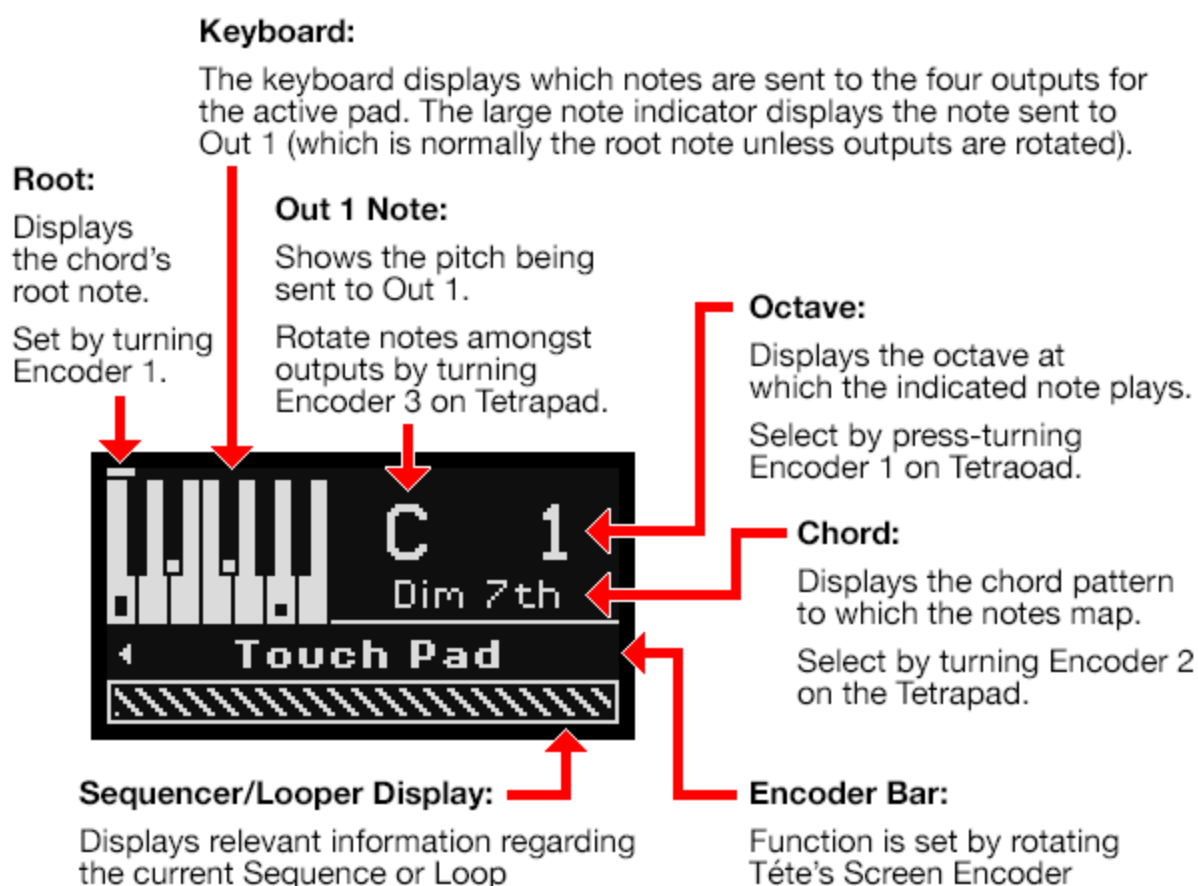

The following illustration shows how Tetrapad's push-encoders, SHIFT button, and Outputs function when assigning notes by Chord. The other functions (common across all Notes Modes) are also shown for convenience.

CLK INPUT
Clock input for syncing Tête's sequencer, looper and other clock based functions to an external clock.

TRIG / RESET INPUTS
These inputs are assignable in the CV Setup menu, which is accessed by pressing the CV button.

X / Y / Z INPUTS
The destination for each input is assignable in the CV Setup menu, which is accessed by pressing the CV button. Use the built-in attenuverters to scale the incoming CV as needed.

SCREEN
Displays relevant parameters and menus for operating Tête and Tetrapad in Notes Mode.

BUTTONS

- SETUP** Press to toggle between the Mode SETUP Menu on & off. Long-press to view the MODE Select Menu.
- CV** Press to assign CV to Tête's inputs & outputs. Long-press to save, load and manage presets.

ENCODER
Sets various parameter values (see documentation)

TEMPO
Long-press to set clock options. Tap to set an internal tempo (determined by time between taps).

LOOPY
Press to toggle Loopy Mode on and off. Hold for momentary Loopy Mode.

PLAY
Press to play/pause. Long-press resets to beginning.

REC
Press to start/stop recording. Press to overdub (punch). Long-press erases recording.

NOTES MODE (SET BY CHORD)

Visual indication of output assignment and voltage:

- Outs 1-4: Indicate Note outputs
- Out 5: Position (any Pad) (brightness = higher absolute voltage)
- Out 6: Pressure (any Pad) (brightness = amount)
- Out 7: Trigger (any Pad)
- Out 8: Gate (any Pad)

1	2	3	4
Set Root	Select Chord	Rotate Chord	Invert Chord
Reset Root to C0	Set to Unison Chord	Clear Rotation	Clear Inversion
Set Octave	---	---	---
Adjust Slew	<i>(Hold SHIFT & turn any encoder to change all slew rates equally)</i>		
Set Slew Limits	<i>(Hold SHIFT & Push+Turn any encoder to set minimum (turn CCW) and max (CV) slew limits for CV)</i>		

Visual indication of octave:

- Higher octaves (brightness = oct height, up to +5 oct)
- Lower octaves (brightness = oct depth, down to -5 oct)

If you hold SHIFT and turn Encoder 1, the LED displays slew rate rather than octave.
Brighter LED = longer slew time: ○ ● ● ●

Hold down SHIFT while turning any Encoder to set a global slew time between notes (portamento).
Hold down SHIFT while press-turning any Encoder to limit the range of CV-able slew.

PADS:
Notes Mode stores virtual 'keyboards' consisting of 4, 8, 12 or 16 virtual pads. Each virtual pad is like a separate key on a keyboard — each capable of sending different user-assignable note values to Tetrapad Outputs 1-4. You can assign notes to virtual pads (keys) either manually, by scale, or by chord.

When configured as 8 virtual pads, each real pad is split into an upper zone and a lower zone, resulting in 8 "keys."

When configured as 12 pads, Tetrapad splits each physical pad into three zones, giving you access to twelve different "keys."

When set to 16 pads, Tetrapad splits each physical pad into four zones, resulting in 16 "keys."

Assigning Notes to the Tetrapad ‘Keyboard’ w/Chord

The following steps discuss using the Chord feature to assign note values to Tetrapad “keys” and outputs:

1. Select whether you want Tetrapad split into 4, 8, 12 or 16 virtual ‘keys’ using the Mode SETUP Menu, as described in [Setting the Number of Virtual Keys](#).
2. In the same Mode SETUP Menu, tell Tetrapad to assign notes **w/Chords**, as described in [Choosing a Note Assignment Method](#).
3. Touch and release one of the 4, 8, 12 or 16 virtual ‘keys’ on the Tetrapad ‘keyboard’.
This selects the ‘keyboard key’ for which you will define note values. The LEDs beneath the key you just touched (the ‘active’ key) are brighter than the other keys.
4. Turn Encoder 1 to set the **root note** of the chord.
5. Press-and-Turn Encoder 1 to set the chord’s **octave**.
6. Turn Encoder 2 to scroll through different **chords** in Tetrapad’s library.

Selecting different chords changes the note assignments for Outs 2, 3 and 4. Tetrapad’s internal library contains the following 12 chords (plus a Unison mode):

Chord Name	Intervals
Unison	0, 0, 0, 0
Major w/octave	0, 4, 7, 12
Minor w/octave	0, 3, 7, 12
Major 7th	0, 4, 7, 11
Minor 7th	0, 3, 7, 10
Dominant 7th	0, 4, 7, 10
Diminished 7th	0, 3, 6, 9
Half-Diminished 7th	0, 3, 6, 10
Minor Major 7th	0, 3, 7, 11
Augmented Major 7th	0, 4, 8, 11
Augmented 7th	0, 4, 8, 10
Diminished Major 7th	0, 3, 6, 11
Dominant 7th flat 5th	0, 4, 6, 10

7. Turn Encoder 3 to **rotate** the output assignment of each note.

With each clockwise rotation, the output assignments shift to the right by 1. So if you rotate Encoder 3 one turn CW, the root note moves to Out 2 and all the other output assignments shift to the right by 1, with note 4 now appearing at Out 1.

NOTE: The brightest of the four blue Output Status LEDs indicates which output is currently assigned to the root note. So, as you turn Encoder 3, the bright blue Output Status LED will rotate among the outputs as the chord rotates.

8. Turn Encoder 4 to **invert** the chord. Clockwise rotation of Encoder 4 inverts the chord upward; Counterclockwise rotation inverts the chord downward.

For example, one CW turn transposes the root note up 1 octave; a second CW turn transposes the second note up 1 octave, and so on. Similarly, one CCW turn transposes the fourth note down 1 octave; etc.

9. Touch each of the remaining virtual 'keys', repeat steps 4-8 to define 4-note chords for each 'key.'

Playing Chords

Once you've assigned chords to all the virtual keys, you're ready to perform.

1. Route Tetrapad's first four outputs to up to four different oscillators.
2. Press one of the virtual 'keys' to send a four-note chord to those oscillators.
3. Press another 'key' to send another four-note chord, etc.
4. Chord mode also features gate, trigger, position and pressure outputs. These are assigned as follows:

Out 5: Vertical Position of whichever pad you're currently touching. Brightness of green Output Status LED indicates absolute level.

Out 6: Pressure of whichever pad you're currently touching. Brightness of teal Output Status LED indicates absolute level.

Out 7: Trigger value sent any time you touch any pad. The magenta Output Status LED turns on, then immediately turns off when a pad is touched — indicating a trigger output.

Out 8: Gate signal sent any time you touch any pad. The magenta Output Status LED turns on and stays on as long as a pad is touched — indicating a gate output.

Route these last four outputs to envelopes or control voltage inputs on other modules to enable more expressive and organic performances.

5. You can rotate note assignments across the four outputs by turning Encoder 3 (or assigning the function to one of Tête's assignable CV inputs), and you can invert chords by turning Encoder 4 (or assigning inversion to one of Tête's assignable CV inputs).

Slew Between Chords

Tetrapad gives you the ability to slew between chord changes. To do so, press the red SHIFT button and continue holding it while turning Encoder 1.

Clockwise turns increase the time it takes to move from one chord to another (up to approximately a 4 second glide). Counterclockwise turns decrease the amount of time it takes to move from one chord to another (down to "instantaneous").

Slew times are indicated by a red Pad Status LED above each fader — with an LED glowing increasingly brighter as the slew gets longer.

Note that slew time is a global setting within Chord Mode, meaning the rate of change affects all chords equally.

NOTE: CV control over slew time is available in Tête's [CV Setup Menu](#). You can limit the extent to which CV can control Slew by holding down the red SHIFT button while pressing & turning any of the four Encoders. Counterclockwise turns set the lower CV-able Slew limit, while clockwise turns set the upper CV-able Slew limit.

Copying & Pasting Chords

You can copy one pad's chord assignment to another pad. To do so:

1. Touch *and hold* the virtual pad that corresponds to the chord you want to *copy*.
2. With your finger still on the pad, press Tetrapad's white EDIT button.

That pad's chord will be copied into temporary memory.

Tête's screen inverts (white background) and the Chord Name Indicator says "**Copy Pad**".



3. Lift your finger from the virtual pad you just copied.
4. Touch *and release* the virtual pad onto which you want to *paste* the copied chord.
The chord will be copied to the new virtual pad.
5. If you want the chord pasted to more than one virtual pad, simply touch the additional pads.
The chord will be copied to each pad you touch.
6. Press Tetrapad's white EDIT button.

Tête's screen reverts to normal (black background), and normal functions are resumed.

Set Notes Manually

This mode uses Tetrapad's encoders to manually map each virtual "key" to a specific note for each output. Manual note assignment is for anyone who wants direct control over the pitch of every key and output, and doesn't wish to be constrained by traditional scales or chords.

When you tell Tetrapad to assign notes **manually**, Tête's screen shows the following information:

KEYBOARD:

The keyboard displays which notes are sent to the four outputs for the active zone.

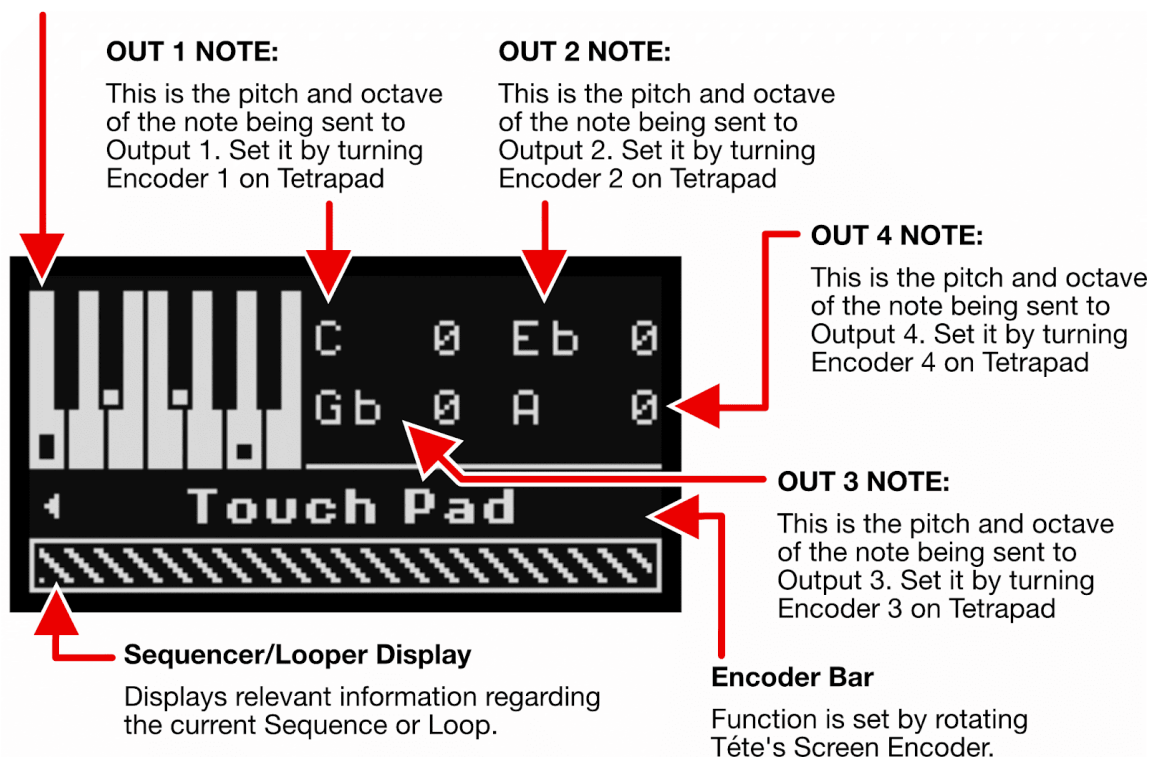

The following illustration shows how Tetrapad's push-encoders, SHIFT button, and Outputs function when assigning notes manually. The other functions (common across all Notes Modes) are also shown for convenience.

CLK INPUT
Clock input for syncing Tête's sequencer, looper and other clock based functions to an external clock.

TRIG / RESET INPUTS
These inputs are assignable in the CV Setup menu, which is accessed by pressing the CV button.

X / Y / Z INPUTS
The destination for each input is assignable in the CV Setup menu, which is accessed by pressing the CV button.
Use the built-in attenuverters to scale the incoming CV as needed.

SCREEN
Displays relevant parameters and menus for operating Tête and Tetrapad in Notes Mode.

BUTTONS

- Press to toggle between the Mode SETUP Menu on & off.
- Long-press to view the MODE Select Menu.
- Press to assign CV to Tête's inputs & outputs.
- Long-press to save, load and manage presets.

ENCODER
Sets various parameter values (see documentation)

TEMPO
Long-press to set clock options. Tap to set an internal tempo (determined by time between taps).

LOOPY
Press to toggle Loopy Mode on and off. Hold for momentary Loopy Mode.

PLAY
Press to play/pause. Long-press resets to beginning.

REC
Press to start/stop recording. Press to overdub (punch). Long-press erases recording.

NOTES MODE (SET MANUALLY)

Visual indication of output assignment and voltage:

- Outs 1-4: Indicate Note outputs
- Out 5: Position (any Pad) (brightness = higher absolute voltage)
- Out 6: Pressure (any Zone) (brightness = amount)
- Out 7: Trigger (any Zone)
- Out 8: Gate (any Zone)

1	2	3	4
Note Sent to Out 1	Note Sent to Out 2	Note Sent to Out 3	Note Sent to Out 4
Reset Out 1 to 0V ("C")	Reset Out 2 to 0V ("C")	Reset Out 3 to 0V ("C")	Reset Out 4 to 0V ("C")
Out 1 Octave	Out 2 Octave	Out 3 Octave	Out 4 Octave
Adjust Slew	<i>(Hold SHIFT & turn any encoder to change all slew rates equally)</i>		
Set Slew Limits	<i>(Hold SHIFT & Push+Turn any encoder to set minimum (turn CCW) and max (CW) slew limits for CV)</i>		

Each zone (key) has its own manual note assignment. Touch a zone to select it for editing.

Visual indication of octave:

- Higher octaves (brightness = oct height, up to +5 oct)
- Lower octaves (brightness = oct depth, down to -5 oct)

If you hold SHIFT and turn Encoder 1, the LED displays slew rate rather than octave.
Brighter LED = longer slew time:

Hold down SHIFT while turning any Encoder to set a global slew time between notes (portamento).

Hold down SHIFT while press-turning any Encoder to limit the range of CV-able slew.

PADS:
Notes Mode stores virtual 'keyboards' consisting of 4, 8, 12 or 16 virtual pads. Each virtual pad is like a separate key on a keyboard — each capable of sending different user-assignable note values to Tetrapad Outputs 1-4.
You can assign notes to virtual pads (keys) either manually, by scale, or by chord.

When configured as 8 virtual pads, each real pad is split into an upper zone and a lower zone, resulting in 8 "keys."

When configured as 12 pads, Tetrapad splits each physical pad into three zones, giving you access to twelve different "keys."

When set to 16 pads, Tetrapad splits each physical pad into four zones, resulting in 16 "keys."

Assigning Notes to the Tetrapad ‘Keyboard’ Manually

The following steps discuss assigning note values to Tetrapad “keys” and outputs:

1. Select whether you want Tetrapad split into 4, 8, 12 or 16 virtual ‘keys’ using the Mode SETUP Menu, as described in [Setting the Number of Virtual Keys](#).
2. In the same Mode SETUP Menu, tell Tetrapad to assign notes **Manually**, as described in [Choosing a Note Assignment Method](#).
3. Touch and release one of the 4, 8, 12 or 16 virtual ‘keys’ on the Tetrapad ‘keyboard’.

This selects the ‘keyboard key’ for which you will define note values. The LEDs beneath the key you just touched (the ‘active’ key) are brighter than the other keys.

Notice that beneath the surface of each pad, there is also a single brightly lit LED, whose vertical position indicates the note value that will be sent to the corresponding Output. That is, the bright LED shown beneath Pad 1 represents the note that appears at Out 1; the bright LED shown beneath Pad 2 represents the note that appears at Out 2; etc.

On Tête, the screen shows all four note assignments, both visually (on the miniature keyboard), and by name/octave.



4. Turn Encoder 1 to change the pitch sent to Out 1. If desired, turn Encoders 2-4 to change pitch assignments for outputs 2-4.

When you set a pitch that’s an octave higher than the default “zero” octave, Tetrapad’s Pad Status LED will glow green. With each subsequent octave increase, the LED will brighten. When the pitch is an octave lower than default, Tetrapad’s Pad Status LED will glow red. With each subsequent octave decrease, the LED will brighten. Pitch can be set over a 10 oct range.

On Tête, the octave is displayed by number for each of the four output notes.

TIP: You can reset any note to its default C0 (0 V) value by pressing the corresponding encoder.

5. Push down and turn Encoder 1 to directly change the *octave* of the note sent to Out 1. If desired, turn Encoders 2-4 to change their octaves.
6. Touch each of the remaining virtual ‘keys’ and repeat steps 4 and 5 to define up to four note values (one note per output) for every key.

Using this technique, you can use the manual note assignment method to create custom chords, if you use multiple oscillators.

Playing the Keyboard

1. Touch any of the 4, 8, 12 or 16 keys (as chosen in [Setting the Number of Virtual Keys](#)) to send the assigned notes to Outputs 1-4.

CV representing the vertical position of your tap on the key is sent to Out 5. CV representing the pressure you apply to any key is sent to Out 6. A trigger signal is sent to Out 7, and a Gate is sent to Out 8.

Slew Between Notes

Tetrapad also gives you the ability to slew between notes. To do so, press the red SHIFT button and continue holding it while turning Encoder 1.

Clockwise turns increase the time it takes to move from one note to another (up to approximately a 4 second glide). Counterclockwise turns decrease the amount of time (down to “instantaneous”).

Slew times are indicated by a red Pad Status LED above each fader — with an LED glowing increasingly brighter as the slew gets longer.

Slew time is a global setting within Keyboard Mode, meaning the rate of change affects all notes equally.

NOTE: CV control over slew time is available in Tête’s [CV Setup Menu](#). You can limit the extent to which CV can control Slew by holding down the red SHIFT button while pressing & turning any of the four Encoders. Counterclockwise turns set the lower CV-able Slew limit, while clockwise turns set the upper CV-able Slew limit.

Rotating and Inverting

If you’ve used manual note assignment to configure your own custom chords, you may find it useful to rotate or invert those chords as part of a performance. Although manual note assignment does not give you direct Encoder access to these functions, you can assign Rotation and Inversion to Tête’s Assignable CV Inputs as discussed in [CV Setup Menu](#).

Copying & Pasting Notes

You can copy one pad's note assignments to another pad's. To do so:

1. Touch *and hold* the virtual pad whose note assignments you want copied.
2. With your finger still on the pad, press Tetrapad's white EDIT button.

That pad's note assignments will be copied into temporary memory.

Tête's screen inverts (white background) — displaying both the name of the note being sent to Out 1, and the words “**Copy Pad**”.



3. Lift your finger from the virtual pad you just copied.
4. Touch *and release* the virtual pad onto which you want to *paste* the copied note assignments.
The note assignments will be copied to the new virtual pad.
5. If you want the notes pasted to more than one virtual pad, simply touch the additional pads.
The notes assignments will be copied to each pad you touch.
6. Press Tetrapad's white EDIT button.

Tête's screen reverts to normal (black background), and normal functions are resumed.

Edit View for Notes Mode

Normally, when you make any changes to a note assignment for a “key”, the edits are applied instantly and are sent immediately to the Tetrapad outputs. However, there may be instances when you would like to make changes to your “keyboard” without affecting the output. This is the purpose of Edit View. Edit View lets you select a pad (“key”) and edit its values without affecting the current output.

1. Short-press (<1 sec) the white EDIT button on Tetrapad.
Tête + Tetrapad enter Edit View. Tetrapad’s SHIFT LED turns **blue** and the Note Display area on Tête’s screen inverts.
2. Touch the pad (“key”) you wish to edit.
3. Edit the pad’s note assignment as previously discussed.
Note editing methodology differs depending on whether you’ve chosen to edit the keyboard manually, by chord, or by scale (as discussed earlier).
Notice that the values change without being sent to the outputs.
4. Continue editing other Pads, and when you’re done, short-press (<1 sec) the white EDIT button to exit Edit View.
5. Touch any pad (“key”), and its newly edited note value is sent to the outputs.

Edit View is particularly useful in performance situations, in which you want to dial in some upcoming changes without affecting what is currently being output. It can be particularly useful when playing back recordings, since Edit View lets you edit note values without triggering unexpected changes or overdubbing/overwriting the currently playing recording.

PART FIVE:
VOLTAGES MODE

VOLTAGES MODE

CLK INPUT
Clock input for syncing Tête's sequencer, looper and other clock based functions to an external clock.

TRIG / RESET INPUTS
These inputs are assignable in the CV Setup menu, which is accessed by pressing the CV button.

X / Y / Z INPUTS
The destination for each input is assignable in the CV Setup menu, which is accessed by pressing the CV button.
Use the built-in attenuverters to scale the incoming CV as needed.

SCREEN
Displays relevant parameters and menus for operating Tête and Tetrapad in Voltages Mode.

BUTTONS

- SETUP** Press to toggle between the Mode SETUP Menu on & off.
Long-press to view the MODE Select Menu.
- CV** Press to assign CV to Tête's inputs & outputs.
Long-press to save, load and manage presets.

ENCODER
Sets various parameter values (see documentation)

TEMPO
Long-press to set clock options. Tap to set an internal tempo (determined by time between taps).

LOOPY
Press to toggle Loopy Mode on and off. Hold for momentary Loopy Mode.

PLAY
Press to play/pause. Long-press resets to beginning.

REC
Press to start/stop recording. Press to overdub (punch). Long-press erases recording.

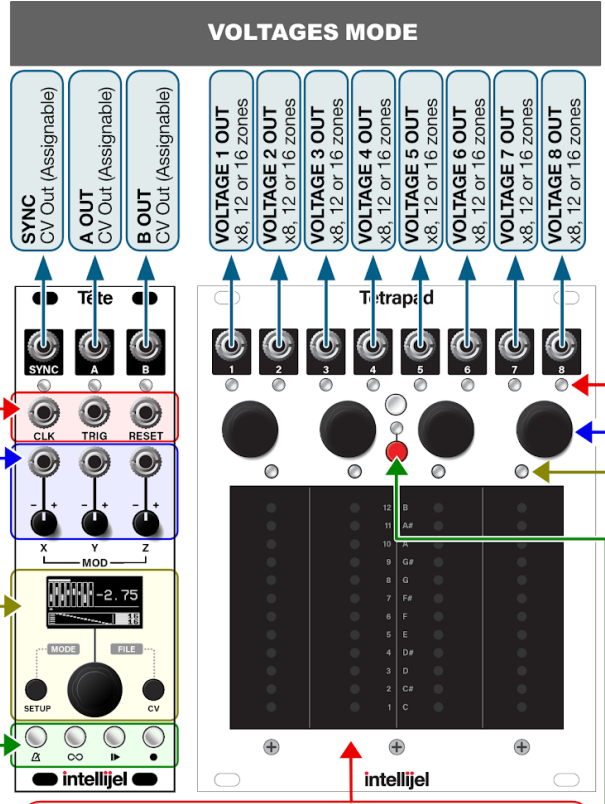

PADS:
Voltages Mode can store banks of 8, 12 or 16 voltages for each of Tetrapad's 8 outputs.

When configured as banks of 8 voltages, the pads are split into two zones. When configured as banks of 12 voltages, the pads are split into three zones. A 16 voltage bank divides the pad into 4 zones.

Each zone stores 8 voltages (one for each output), so touching a zone sends 8 different stored voltages out Tetrapad's 8 outputs.

If an output is slewed, then pressure can control the rate. Specifically, pressing harder on a button quickens the rate of change.

Voltages can be entered precisely, they can be randomized (within a user-selectable range), or they can be quantized to a selectable scale.

Visual indication of output voltage:

- Positive voltage
- Negative voltage
- Quantized (Note) voltage

(Brightness = higher absolute voltage.)

- If SHIFT LED is **GREEN**, turning encoders 1 - 4 assigns voltage to Outs 1 - 4, respectively.
- If SHIFT LED is **RED**, turning encoders 1 - 4 assigns voltages to Outs 5 - 8, respectively.

In both cases, turn the encoder slowly to change voltage in fine increments. Turn it rapidly to set voltage in larger increments.

- Press an encoder to quantize the corresponding output to voltages that conform to the scale set in the Mode Setup Menu.
- Press an encoder **while holding your finger to one of the zones** to reset its corresponding output voltage to 0V.
GREEN SHIFT LED = Outs 1-4
RED SHIFT LED = Outs 5-8
- Hold the SHIFT button and press an encoder to randomize the corresponding output value for all Banks.
GREEN SHIFT LED = Outs 1-4
RED SHIFT LED = Outs 5-8

Slew Time
(brighter = slower)

Changes which OUT each encoder controls:

- Encoders 1-4 = OUTS 1-4
- Encoders 1-4 = OUTS 5-8

RANDOMIZE BANK: Hold your finger on a zone (virtual pad) and press SHIFT to randomize all 8 output voltages.

RANDOMIZE ALL: Hold down SHIFT and short-press (<1 sec) the white CONFIG button to randomize all banks for all pads.

RANDOMIZE AN OUT FOR ALL BANKS: Hold down SHIFT and press an encoder to randomize the corresponding output value for all Banks.

RESET ALL: Hold down SHIFT and long-press (>1 sec) the white CONFIG button to reset all voltages in all banks to 0V.

SLEW: Hold down SHIFT while turning Encoder 1 to set a slew time between voltage changes.

Imagine pushing a single button that sends one voltage to a filter's cutoff frequency, another voltage to its resonance, a third to a Quadrax CV to control a function's attack time, and a fourth to another Quadrax CV input to control its decay time. Imagining using a fifth output to change waveshapes on a Shapeshifter, and the sixth to set the amount of wave folding. Output 7 could change the grain size in Rainmaker, while Output 8 could adjust its wet/dry mix. When used this way, Voltages Mode is almost like having patch memory within Eurorack.

Voltages Mode divides each pad into either two, three or four regions, giving you access to 8, 12, or 16 voltage banks, each of which can store 8 voltages (one for each output). Touching a zone on Tetrapad sends a different stored voltage to each of the 8 outputs.

Tête can also record and play back notes in real-time (using its built-in [Looper](#)) or in step-time (using its built-in [Sequencer](#)).

The addition of Tête's assignable CV inputs allows further motion sequencing by shifting zones vertically and horizontally, and you can slew between voltages, and vary the slew amount via another Tête CV input.

Entering Voltages Mode

To enter Voltages Mode:

1. Long-press (>1 sec) the **SETUP MODE** button to display the MODE Select Menu.
2. Rotate the screen encoder to highlight **Voltages**, then press the encoder to select it.

The Voltages Mode screen appears and Tetrapad switches to Voltages Mode.

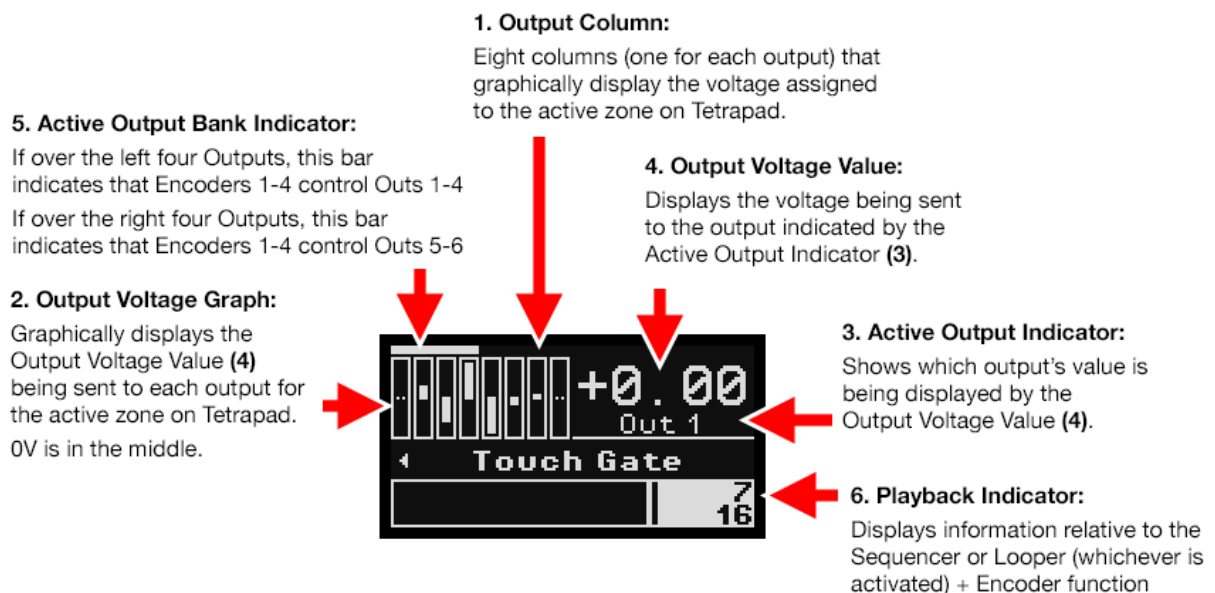

Setting the Number of Voltage Banks

One of the first things you'll wish to do in Voltages Mode is to divide Tetrapad's four physical pads into either 8, 12, or 16 virtual pads, with each virtual pad capable of storing a bank of 8 voltages. To do so:

1. Press Tête's **SETUP MODE** button to display the Mode SETUP Menu.
2. Rotate Tête's screen encoder to select the **Pads** option, then press the encoder.
3. Rotate the encoder to select between **8**, **12**, and **16**, then press the encoder to apply your selection.

Tetrapad will divide its four physical pads into either 2, 3 or 4 zones, giving you either 8, 12 or 16 virtual pads (banks).

4. Press Tête's **SETUP MODE** button exit the Mode SETUP Menu.

Assigning Voltage Values

After you assign either 8, 12, or 16 voltage banks to Tetrapad, you next need to assign up to eight output voltages (one for each physical output on Tetrapad) to each of the 8, 12 or 16 virtual pads (bank).

You can do this either manually or randomly.

Manual Voltage Assignment

1. Touch one of the 8, 12 or 16 virtual pads on Tetrapad
2. If Tetrapad's SHIFT LED is **red**, press the red SHIFT button to make the LED **green**.
When the SHIFT LED is **green**, you can assign voltages to outputs 1-4. When it's **red**, you can assign voltages to outputs 5-6. Pressing the red SHIFT button toggles between these two settings. In addition, the Active Output Bank Indicator on Tête's screen graphically depicts which set of outputs are being edited.
3. Rotate Tetrapad Encoder 1 to assign a voltage to output 1.
Turn an encoder slowly to set the voltage value in fine (.01V) increments. Turn it rapidly to set voltages coarsely.
4. Rotate Tetrapad Encoders 2-4 to assign voltages to outputs 2-4.
5. Press the red SHIFT button (turning the SHIFT LED **red**), then rotate Tetrapad Encoders 1-4 to assign voltages to outputs 5-8.
6. Touch another of the 8, 12 or 16 virtual pads on Tetrapad and repeat steps 2-5.
7. Continue making manual assignments for each of Tetrapad's 8, 12, or 16 virtual pads (banks).

The following diagram illustrates this basic functionality within Voltages Mode:

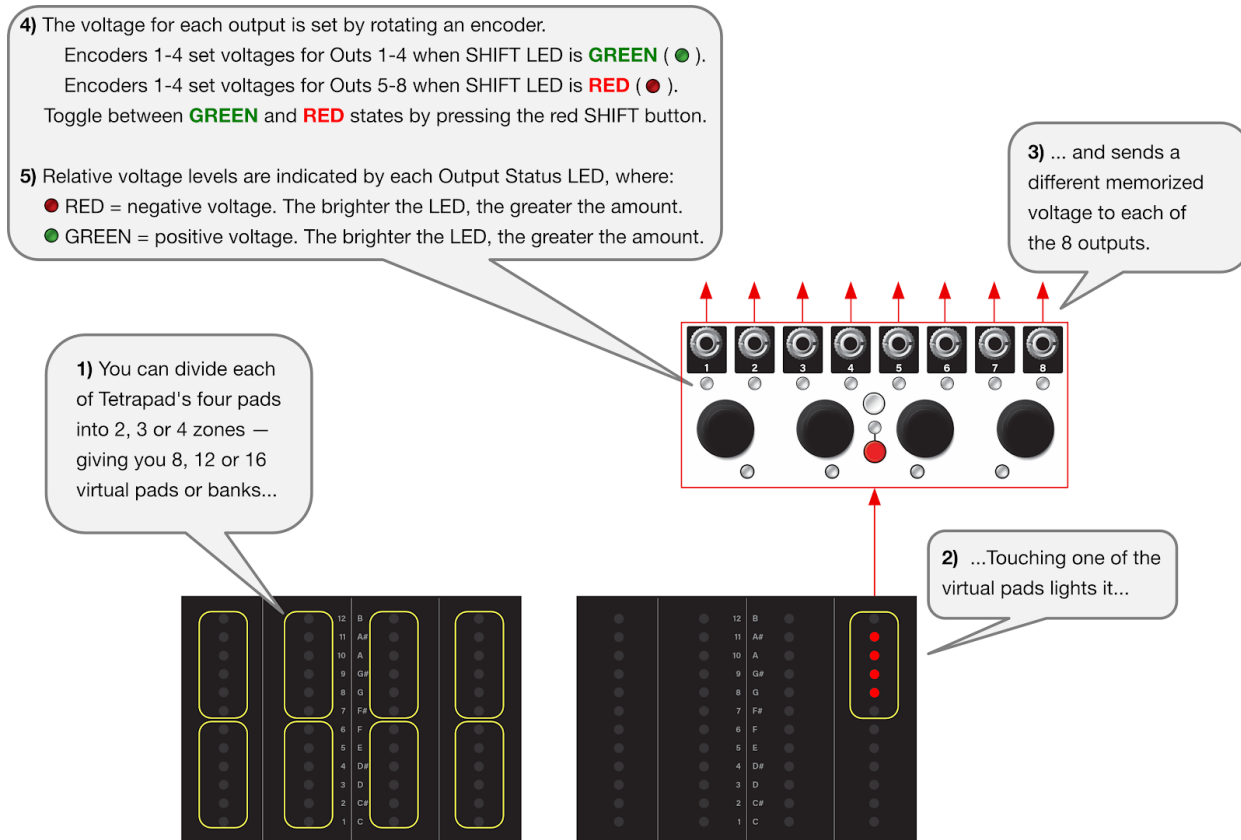

NOTE: You can quickly scroll through all 8 outputs and see their assigned values by entering [Edit View for Voltages Mode](#) (short-press the white EDIT button), then rotating Tête's encoder to select which output's voltage value you wish to view.

Random Voltage Assignment

You can randomize a single output voltage in all banks; all output voltages in a bank; or all output voltages for all banks. The range of randomized values is set with the **Random Min** and **Random Max** parameters in the [Voltages Mode SETUP Menu](#), enabling you to define a randomization range as wide as 10V (-5V to +5V) or as narrow as a single volt.

To randomize a single output voltage in all banks:

1. Hold the red SHIFT button down, and press one of the four encoders.

This generates a random voltage out the corresponding output across all banks.

If the SHIFT LED is **green**, pressing encoders 1 thru 4 randomizes the voltages sent to Outputs 1 thru 4, respectively. If the SHIFT LED is **red**, pressing encoders 1 thru 4 randomizes the voltages sent to Outputs 5 thru 8, respectively. Pressing the red SHIFT button toggles between these two states.

To randomize all output voltages in a bank:

1. Touch a virtual pad and keep your finger on the desired pad (bank).
2. Press the red SHIFT button.

All eight output voltages (the entire bank) are simultaneously randomized for that pad.

To randomize all output voltages for all banks:

1. Hold the red SHIFT button down and short-press (<1 sec) the white EDIT button.

Every bank is randomized. That is, all output voltages are randomized for every virtual pad.

NOTE: You can also randomize all output voltages for all pads by selecting the “Randomize Banks” option in the Mode Setup menu for Voltages Mode.

To clear all output voltages for all banks (resetting all voltages to 0V):

1. Hold the red SHIFT button down and long-press (>1 sec) the white EDIT button.

Every output voltage for every bank is set to 0V.

NOTE: You can also clear all output voltages by selecting the “Clear Banks” option in the Mode Setup menu for Voltages Mode.

Reset a Voltage

To quickly reset a voltage to 0V:

1. Touch a virtual pad and keep your finger on the pad (bank).
2. Press an Encoder to reset the corresponding output voltage to 0V.

If the SHIFT LED is **green**, the four encoders reset Outputs 1-4. If the SHIFT LED is **red**, the four encoders reset Outputs 5.-6. Pressing the red SHIFT button toggles between these two states.

Slew Between Voltages

Normally, output voltages change instantly when you press different virtual pads (banks) on Tetrapad. However, it's possible to assign a slew, so that the voltages change gradually.

To slew between voltages:

1. Hold down the red SHIFT button and rotate any of the four Encoders.

Slew is global, and affects all 8 outputs simultaneously.

Clockwise rotations increase the time it takes to switch from one voltage to another (up to a maximum of about two minutes to complete a 10 V change). Counterclockwise turns decrease the amount of time it takes to switch between voltages (down to “instantaneous”).

The slew time is indicated by a red Pad Status LED above all four pads — with the LED glowing increasingly brighter as the slew gets longer. When there is no slew (Shift-hold and turn encoder counterclockwise), the LED is not lit.

Quantizing Voltage Values

Output voltages can be quantized to conform to a chosen musical scale. To do so:

1. Press a pad's encoder to toggle output quantization on/off.

When an output voltage is quantized, its Output Status LED turns blue, indicating the jack contains pitched voltages.

2. On Tête, press the **SETUP MODE** button to display the Mode SETUP menu.
3. Turn Tête's encoder to select the Scale and Scale Root options, and set them to the desired values as discussed further in [Voltages Mode SETUP Menu](#).
4. Press the **SETUP MODE** button again to exit the Mode SETUP menu and return Tête to its default display.

Output voltages will now be quantized to conform to the chosen musical scale.

Edit View for Voltages Mode

Normally, when you make any changes to a voltage bank, the edits are applied instantly and are sent immediately to the Tête and Tetrapad outputs. However, there may be instances when you would like to make changes to a bank (or banks) without affecting the output. This is the purpose of Edit View. Edit View lets you select a bank (pad) and edit its values without affecting the current output.

1. Short-press (<1 sec) the white EDIT button on Tetrapad.

Tête + Tetrapad enter Edit View. Tetrapad's SHIFT LED turns **blue** and the Voltage Value area on Tête's screen inverts, and Tête's Encoder Bar displays "Select Output."



2. Touch the bank (pad) you wish to edit.
3. Edit the output voltages using Tetrapads four encoders and its red SHIFT button (as discussed above).

Notice that the values change without being sent to the outputs.

Notice, also, that you can rotate Tête's encoder to see the actual voltage value assigned to each output, without having to edit it first.

4. Continue editing other banks, and when you're done, short-press (<1 sec) the white EDIT button to exit Edit View.
5. Touch any bank (pad), and its newly edited values are sent to the outputs.

Edit View is particularly useful in performance situations, in which you want to dial in some upcoming changes without affecting what is currently being output. For example, assume that Bank 1 is active and currently outputting voltages. While it plays, you want to jump into Bank 3 and make one or more changes before actually switching to Bank 3 — all without affecting what you're currently hearing from Bank 1. To do this, simply press EDIT, select Bank 3, make your modifications, then exit Edit View. Your changes will be ready to transmit whenever you press the Bank 3 pad, and your edits will have been made silently.

Edit View is also useful when playing back recordings, since they let you edit bank values without triggering unexpected voltage changes or overdubbing/overwriting the currently playing recording.

Copying & Pasting Voltage Banks

You can copy one bank of voltages to another bank. To do so:

1. Touch *and hold* the virtual pad that corresponds to the bank of voltages you want to *copy*.
2. With your finger still on the pad, press Tetrapad's white EDIT button.

That pad's bank of voltages will be copied into temporary memory.

On Tête's screen, the area containing the Output Voltage Indicator will invert (white background) and the Active Output Indicator will say "**Copy <n>**" where <n> is the number of the pad (voltage bank) you just copied.



3. Lift your finger from the virtual pad you just copied.
4. Touch *and release* the virtual pad onto which you want to *paste* the copied voltage bank.
The voltage bank will be copied to the new virtual pad.
5. If you want the voltage bank pasted to more than one virtual pad, simply touch the additional pads.

The voltage bank will be copied to each pad you touch.

6. Press Tetrapad's white EDIT button.

Tête's screen reverts to normal (black background), and normal functions are resumed.

PART SIX:
MENUS

MENU OVERVIEW

Various menus are accessible on the Tête screen. Specifically:

- MODE Select Menu:** This is the top-level Tête menu, and is used for assigning Tête/Tetrapad's operational mode. To access this menu, long-press (>1 sec) the **SETUP MODE** button to the left of Tête's screen. Tête's top-level modes are discussed in [MODE Select Menu](#), below.
- Mode SETUP Menu:** Each of Tête's operational modes has a specific set of parameters, which are accessed from this menu. To access this menu, short-press (<1 sec) the **SETUP MODE** button to the left of Tête's screen. The contents of this menu change depending upon which global mode is currently assigned to Tête/Tetrapad. For more information, see [Mode SETUP Menu](#), below.
- CV Setup Menu:** Five of Tête's six input jacks and all three of its output jacks are fully user-assignable through this menu. To access this menu, short-press (<1 sec) the **CV FILE** button to the right of Tête's screen. For more information, see [CV Setup Menu](#), later in this manual.
- FILE Menu:** Use this menu to load and save Tête presets. To access this menu, long-press (>1 sec) the **CV FILE** button. For more information, see [FILE Menu](#), later in this manual.
- TEMPO Menu:** Use Tête's TEMPO menu to choose whether Tête's tempo is set externally or internally. Internal tempos can be set directly within the TEMPO menu (or by tapping the TEMPO button repeatedly at the desired beat). To access this menu, long-press (>1 sec) the **TEMPO (A)** button. For more information, see [TEMPO Menu](#), later in this manual.

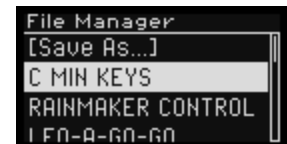
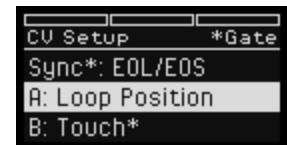
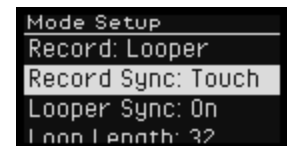

MODE Select Menu

Long-press (>1 sec) the **SETUP MODE** button to display the MODE Select Menu:

Rotate the screen encoder to highlight the desired mode, then press the encoder to select it. Mode options are:

- Combo:** In this mode, each of Tetrapad's four pads can be assigned a function independent of the other three pads, such as: a fader; a bi-polar fader; a crossfader; an LFO; a dual switch; or a euclidean rhythm / finger drumming pad. The chosen mode determines what type of signal (CV, note, trigger, gate, etc.) is sent from each of Tetrapad's eight independent outputs, while its multitude of multi-colored LEDs keep you informed of exactly what's happening within each mode.
- Notes:** This mode divides Tetrapad's four pads into 8, 12, or 16 zones. Each zone is like a key on a keyboard, and can be user-configured (manually, by scale, or by chord) to output different notes to four different outputs.
- Voltages:** This mode divides Tetrapad's four pads into 8, 12, or 16 zones. Each zone is a voltage storage bank, which sends 8 different memorized voltages to Tetrapad eight outputs.

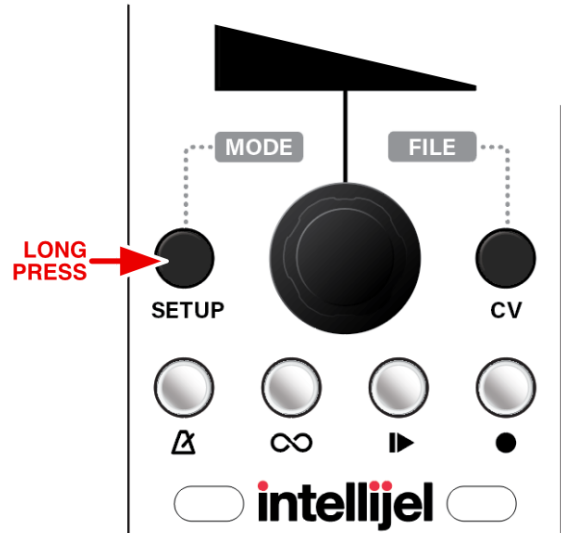

Mode SETUP Menu

Once you've selected the desired Mode (as described above), short-press (<1 sec) the **SETUP MODE** button to display its SETUP options.

Rotate the screen encoder to highlight the parameter you wish to edit. The various SETUP menu options are discussed on the following pages.

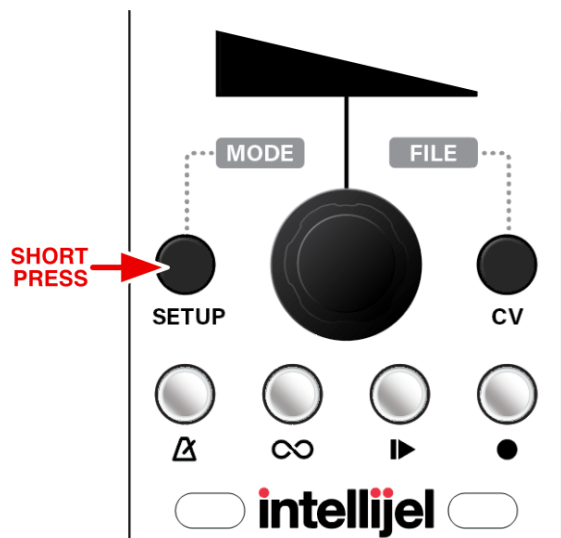

Combo Mode SETUP Menu

When in Combo Mode, the Mode SETUP Menu contains the parameters shown to the right. The configuration of some parameters affects the availability of other parameters, as indicated.

To select a parameter for editing, rotate the encoder to highlight it.

To edit a parameter, press the encoder on the highlighted parameter to make it available for editing. Rotate the encoder to select the desired value, and press the encoder again to apply your change.

Combo Mode SETUP Menu options are:

- **Post Record:** (Play, Overdub)

Overdub: When the Looper transitions out of its record state and into playback (for example by pressing the **PLAY (▶)** button to end a recording), this choice tells Tête to immediately enter Overdub mode.

Play: When the Looper transitions out of its record state and into playback (for example, by pressing the **PLAY (▶)** button to end recording), this choice tells Tête to immediately begin playing the loop without enabling overdub capability.

- **Record Wait:** (Off, Touch)

Touch: Pressing the Record button record-enables Tête, but recording does not actually begin until you touch a pad. If **Looper Sync** is set to *On*, then you must be touching a pad at the start of a loop cycle in order to record.

Off: Pressing the Record button causes Tête to immediately begin recording, whether you touch a pad or not. If **Looper Sync** is set to *On*, then recording begins at the start of the next loop cycle. This lets you synchronize recording to a tempo (either internal or external).

Mode SETUP Menu (Combo Mode)

Post Record: (OvrDub, Play)

Record Wait: (Off, Touch)

Looper Sync: (Off, On)

if On:

Loop Length: (n)

If Off:

Loopy Pos. Sync: (Off, On)

LFO Sync: (On, Off)

LFO Reset: (No, Reset, Loop/Seq)

Euclidean Swing: (%)

Scale: (n)

Scale Root: (n)

Reset Mode...

Global Setup...

- **Looper Sync:** (Off, On)

On: Synchronizes Tête's recording length to the clock (internal or external) or to a TRIG signal (if defined in the CV Setup menu), meaning recording commences 'on the beat,' and it stops 'on the beat.' Looper Sync works in conjunction with the **Loop Length** setting, which follows it in SETUP Menu. The entire process is described in [Record & Play with Looper Sync](#), later in this manual.

NOTE: If you assign one of Tête's CV inputs (such as the TRIG input) to "Looper" in the [CV Setup Menu](#), then the Looper will sync to the pulse present at the TRIG input, rather than the Clock.

Off: Turns off Looper Sync, meaning recording starts and stops the instant you press the **RECORD (●)** button (unless **Record Wait** is set to *Touch*).

- **Loop Length:** (n) (Available if Looper Sync = On)

This parameter is available when **Looper Sync** is *On*. Use it to set the desired loop length (expressed in 'number of beats') for your recording. If you select a number, then Tête will automatically record for that number of beats. If you select "-", Tête will begin recording on the beat, but will record for as long as you like, stopping on the first beat after you stop recording. The entire process is described in [Record & Play with Looper Sync](#), later in this manual.

NOTE: If you assign one of Tête's CV inputs (such as the TRIG input) to "Looper" in the [CV Setup Menu](#), then the Loop Length parameter is decoupled from the Clock, and instead counts the number of pulses received at the TRIG input.

- **Loopy Pos. Sync:** (On, Off) (Available if Looper Sync = Off)

After [Loopy](#) has played back a series of sub-loops, playback of the full-length Loop or Sequence is resumed. The precise position at which playback resumes is determined by this parameter. Specifically:

On: When you exit Loopy playback, the playhead will snap to the position it would have been in had you not activated Loopy. Note that when **Looper Sync** is *On*, then **Loopy Pos. Sync** is automatically turned *On*, and cannot be turned off.

Off: When you exit Loopy playback, the playhead will continue from its current position within Loopy's sub-loop.

Both of these options (and their effect on either Looper or Sequencer modes) are discussed in [Position Sync with Sequences](#) and [Position Sync with Loops](#), later in this manual.

- **LFO Sync:** (On, Off)

On: Any Combo Mode pad assigned as an LFO will synchronize its LFO rate to Tête's clock (which can be either internally generated or synchronized to an external clock via Tête's CLK input), as discussed in [TEMPO Menu](#). When synchronized, touching a pad in the middle sets an LFO rate equal to the clock rate. Touching higher multiplies the clock rate — up to 32x at the highest vertical position. Touching lower on the pad divides the clock rate — down to 1/32 at the lowest vertical position.

Off: Any Combo Mode pad assigned as an LFO will ignore Tête's clock and the vertical position of your finger on an LFO pad will vary the frequency directly, with a touch in the middle producing a 1Hz (1 sec cycle) LFO. Touching at the bottom slows the rate to 16.6667mHz (60 sec Cycle); while touching at the very top outputs a 100 Hz (10ms cycle) LFO. Touching between these extremes scales the rate accordingly.

- **LFO Reset:** (No, Reset, Loop/Seq)

No: Any Combo Mode pad assigned as an LFO will run freely, and the phase will not reset.

Reset: LFOs will reset their cycles when a Reset signal is detected. In order to be detected, a Reset signal needs to be assigned to a Tête input jack (such as the RESET jack or the TRIG jack).

Loop/Seq: Any Combo Mode pad assigned as an LFO will reset its cycle at the beginning of a recorded loop. Similarly, if a Loop is stopped and you press Tête's PLAY button, the LFOs all reset.

- **Euclidean Swing:** (50%, 54%, 58%, 62%, 66%, 70%, 75%, 78%)

Sets the amount of swing to apply to the beat of any Euclidean pad. Swing adds a delay to every other beat (thus, causing it to 'swing'). Tête's swing percentages match those available in the Steppy module, and also conform to the MPC "standard" (with the addition of 78%).

- **Scale: (n)**

If you enable quantization for any pad in Combo mode, then the selection you make here determines the scale to which the pad's values are quantized.

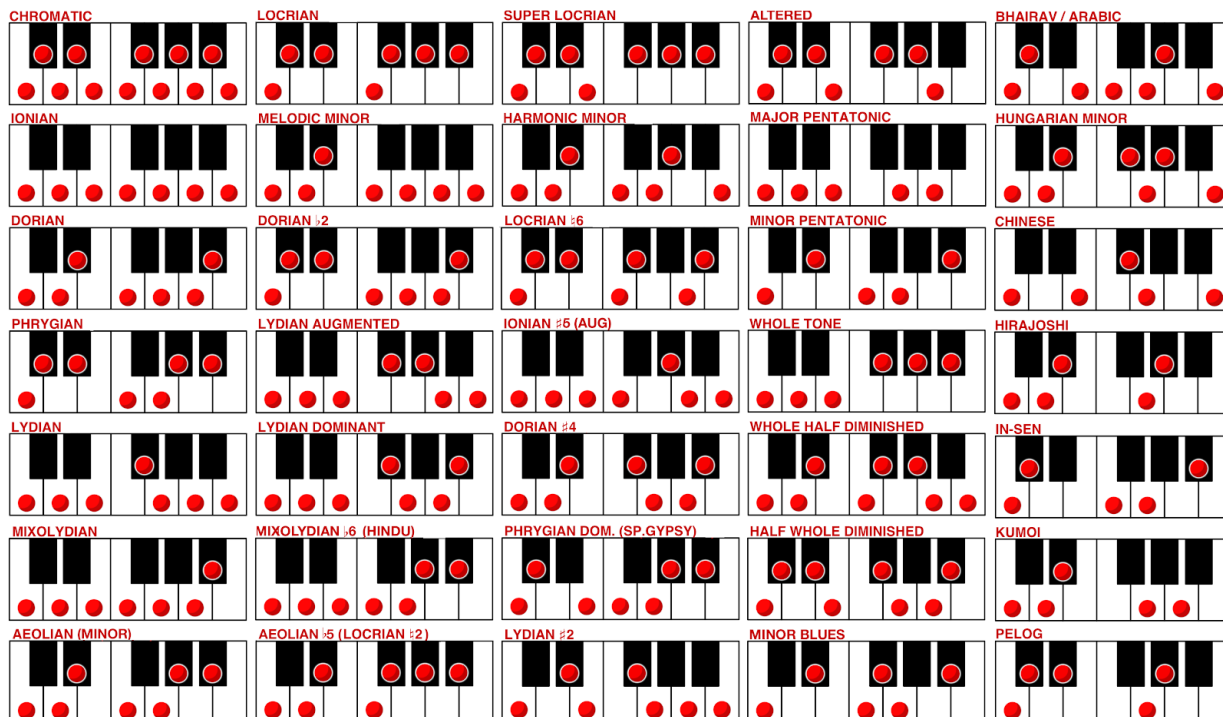

- **Scale Root: (n)**

If you enable quantization for any pad in Combo mode, then the selection you make here determines the root note of the scale to which the pad's values are quantized.

- **Reset Mode...**

Resets all the parameters in the Mode SETUP menu to their factory default settings. You will be asked to confirm your choice. Note that only the settings of the currently active mode (Combo, Notes, Voltages) are reset when you apply this option.

- **Global Setup...**

Opens a sub-menu of global settings, which are discussed in [Global Setup Menu](#), later in this manual.

Notes Mode SETUP Menu

When in Notes Mode, the Mode SETUP Menu contains the parameters shown to the right. The configuration of some parameters affects the availability of other parameters, as indicated.

To select a parameter for editing, turn the encoder to highlight it.

To edit a parameter, press the encoder on the highlighted parameter to make it available for editing. Turn the encoder to select the desired value, and press the encoder again to apply your change.

Notes Mode SETUP Menu options are:

- **Record:** (Looper, Sequencer)

Toggles between two ways of recording notes.

“Sequencer” enables step-recording of notes.

“Looper” enables real-time recording of notes.

[Sequencing](#) and [Looping](#) are both discussed in their own sections, later in the manual.

The recording method you choose (“Sequencer” or “Looper”) determines which parameters appear beneath it in the Mode SETUP menu.

If Record = Looper, then these options (as described previously in [Combo Mode SETUP Menu](#)) are available:

- **Post Record:** (OvrDub, Play) *(Available if Record = Looper)*
- **Record Wait:** (Off, Touch) *(Available if Record = Looper)*
- **Looper Sync:** (Off, On) *(Available if Record = Looper)*
- **Loop Length:** (n) *(Available if Looper Sync = On)*
- **Loopy Pos. Sync:** (On, Off) *(Available if Looper Sync = Off)*

If Record = Sequencer, then these options are available:

- **Seq Clock:** (/n, *n)

Divides or multiplies the clock Tête uses to advance the sequencer. This can be either the internally generated clock, or an external clock sent into Tête’s CLK input), as discussed in [TEMPO Menu](#).

Mode SETUP Menu (Notes Mode)

Record: (Looper, Sequencer)

if Looper:

Post Record: (OvrDub, Play)

Record Wait: (Off, Touch)

Looper Sync: (Off, On)

if On:

Loop Length: (n)

if Off:

Loopy Pos. Sync: (Off, On)

If Sequencer:

Seq. Clock: (/n, *n)

Seq. Swing: (%)

Loopy Pos. Sync: (Off, On)

Pads: (4, 8, 12, 16)

Assign: (w/Scale, w/Chords, Manually)

if w/Scales:

Scale: (n)

if w/Chords or Manually:

Clear All Pads

Reset Mode...

Global Setup...

- **Seq. Swing:** (50%, 54%, 58%, 62%, 66%, 70%, 75%, 78%)

Sets the amount of swing to apply to the beat. Swing adds a delay to every other beat (thus, causing it to 'swing'). Tête's swing percentages match those available in the Steppy module, and also conform to the MPC "standard" (with the addition of 78%).

*NOTE: If **Seq Clock** is set to multiply the clock to anything more than *1, then the **Seq. Swing** parameter has no effect, and is not available in the menu.*

- **Loopy Pos. Sync:** (Loop, Lock)

Unlike when **Record** is set to *Looper*, this option is always available in Sequencer Mode, and works as described previously in [Combo Mode SETUP Menu](#).

- **Pads:** (4, 8, 12, 16)

Sets the number of notes accessible by Tetrapad's 'keyboard.' If **8** is selected, each of the four pads is divided into a top section and a bottom section (giving you an 8 note 'keyboard'). If **12** is selected, each of the four pads is divided into a top, middle and bottom section (giving you a 12 note 'keyboard'). And if **16** is selected, each of the four pads is divided into quarters (giving you a 16 note 'keyboard').

- **Assign:** (w/Scale, w/Chords, Manually)

Tetrapad uses this setting to assign notes to each pad. Each method is described in detail in the following sections of the manual:

w/Scale: See "[Assigning Notes to the Tetrapad 'Keyboard' w/Scale.](#)"

w/Chords: See "[Assigning Notes to the Tetrapad 'Keyboard' w/Chord.](#)"

Manually: See "[Assigning Notes to the Tetrapad 'Keyboard' Manually.](#)"

- **Scale: (n)** (Available if Assign = “w/Scale”)

Sets to the scale to which Tetrapad’s ‘keys’ (virtual pads) are assigned to notes when using Notes Mode and assigning notes using the **Assign: w/Scale** option (described above).

The following scales are available (all illustrations assume a root of C):



- **Clear All Pads** (Available if Assign = “w/Chords” or “Manually”)

Press Tête’s Screen Encoder to reset all four outputs on all virtual keys (pads) to C0, clearing all current chord or manual note assignments.

A “dialog box” appears, asking you to confirm whether or not you want to clear all pads. Turn the Screen Encoder to select “Yes,” then press the Encoder to clear.

- **Reset Mode...**

Resets all the parameters in the Mode SETUP menu to their factory default settings. You will be asked to confirm your choice. Note that only the settings of the currently active mode (Combo, Notes, Voltages) are reset when you apply this option.

- **Global Setup...**

Opens a sub-menu of global settings, which are discussed in [Global Setup Menu](#), later in this manual.

Voltages Mode SETUP Menu

When in Voltages Mode, the Mode SETUP Menu contains the parameters shown to the right. The configuration of some parameters affects the availability of other parameters, as indicated.

To select a parameter for editing, turn the encoder to highlight it.

To edit a parameter, press the encoder on the highlighted parameter to make it available for editing. Turn the encoder to select the desired value, and press the encoder again to apply your change.

Voltages Mode SETUP Menu options are:

- **Record:** (Looper, Sequencer)

Toggles between two ways of recording voltage changes.

“Sequencer” enables step-recording of voltage changes. “Looper” enables real-time recording of voltage changes. [Sequencing](#) and [Looping](#) are both discussed in their own sections, later in the manual.

The recording method you choose (“Sequencer” or “Looper”) determines which parameters appear beneath it in the Mode SETUP menu.

If Record = Looper, then these options (as described previously in [Combo Mode SETUP Menu](#)) are available:

- **Post Record:** (Ovrdub, Play) *(Available if Record = Looper)*
- **Record Wait:** (Off, Touch) *(Available if Record = Looper)*
- **Looper Sync:** (Off, On) *(Available if Record = Looper)*
- **Loop Length:** (n) *(Available if Looper Sync = On)*
- **Loopy Pos. Sync:** (On, Off) *(Available if Looper Sync = Off)*

If Record = Sequencer, then these options are available:

- **Seq Clock:** (/n, *n)

Divides or multiplies Tête’s clock (which can be either internally generated or synchronized to an external clock via Tête’s CLK input), as discussed in [TEMPO Menu](#).

Mode SETUP Menu (Voltages Mode)

Record: (Looper, Sequencer)

if Looper:

Post Record: (Ovrdub, Play)

Record Wait: (Off, Touch)

Looper Sync: (Off, On)

if On:

Loop Length: (n)

if Off:

Loopy Pos. Sync: (Off, On)

If Sequencer:

Seq. Clock: (/n, *n)

Seq. Swing: (%)

Loopy Pos. Sync: (Off, On)

Banks: (8, 12, 16)

Clear Banks

Random Min: (voltage)

Random Max: (voltage)

Randomize Banks

Scale: (n)

Scale Root: (n)

Reset Mode...

Global Setup...

- **Seq. Swing:** (50%, 54%, 58%, 62%, 66%, 70%, 75%, 78%)

Sets the amount of swing to apply to the beat. Swing adds a delay to every other beat (thus, causing it to 'swing'). Tête's swing percentages match those available in the Steppy module, and also conform to the MPC "standard" (with the addition of 78%).

*NOTE: If **Seq Clock** is set to multiply the clock to anything more than *1, then the **Seq. Swing** parameter has no effect, and is not available in the menu.*

- **Loopy Pos. Sync:** (Loop, Lock)

Unlike when **Record** is set to *Looper*, this option is always available in Sequencer Mode, and works as described previously in [Combo Mode SETUP Menu](#).

- **Banks:** (8, 12, 16)

Sets the number of Voltage Banks accessible by Tetrapad. If **8** is selected, each of the four pads is divided into a top section and a bottom section (giving you 8 voltage banks). If **12** is selected, each of the four pads is divided into a top, middle and bottom section (giving you 12 voltage banks). And if **16** is selected, each of the four pads is divided into quarters (giving you access to 16 voltage banks).

- **Clear Banks**

Press Tête's Screen Encoder to reset all voltages in all banks to 0V.

A "dialog box" appears, asking you to confirm whether or not you want to clear all banks. Turn the Screen Encoder to select "Yes," then press the Encoder to clear.

- **Random Min** (voltage)

Sets the minimum possible voltage generated whenever you tell Tête to randomize a voltage. Using this setting in combination with the *Random Max* parameter (below) lets you define a randomization range as wide as 10V (-5V to +5V) or as narrow as a single volt.

- **Random Max** (voltage)

Sets the maximum possible voltage generated whenever you tell Tête to randomize a voltage. Using this setting in combination with the *Random Min* parameter (above) lets you define a randomization range as wide as 10V (-5V to +5V) or as narrow as a single volt.

- **Randomize Banks**

Press Tête's Screen Encoder to randomize all output voltages in every bank.

A "dialog box" appears, asking you to confirm whether or not you want to clear your current settings and randomize all banks. Turn the Screen Encoder to select "Yes," then press the Encoder to randomize.

- **Scale: (n)**

If you enable voltage quantization in Voltages mode (pressing a pad's encoder toggles output quantization on/off), then the selection you make here determines the scale to which those voltages are quantized.



- **Scale Root: (n)**

If you enable voltage quantization in Voltages Mode (pressing a pad's encoder toggles output quantization on/off), then the selection you make here determines the root note of the scale to which those voltages are quantized.

- **Reset Mode...**

Resets all the parameters in the Mode SETUP menu to their factory default settings. You will be asked to confirm your choice. Note that only the settings of the currently active mode (Combo, Notes, Voltages) are reset when you apply this option.

- **Global Setup...**

Opens a sub-menu of global settings, which are discussed in [Global Setup Menu](#), later in this manual.

Global Setup Menu

This menu contains a number of global settings.

- **Pres. Curve:** (Square, Linear, Exponential, Logarithmic)

Sets the desired pressure response curve on Tetrapad. There are four options: Square (factory default); 2: Linear; 3: Exponential; and 4: Logarithmic.

These are indicated graphically in the following illustration:

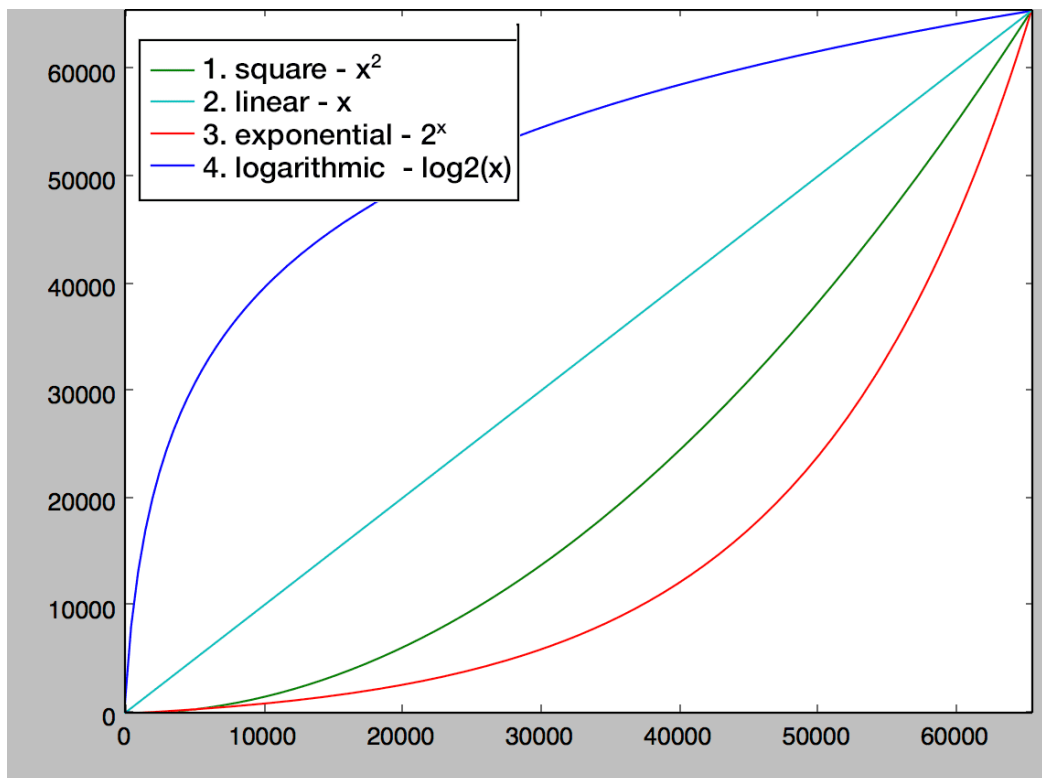

- **Pressure Filter:** (1 - 12)

There are 12 filtration levels for Tetrapad, numbered 1-12. Higher numbers are more sensitive to pressure variation than lower numbers. Tetrapad ships with a default level of 7.

- **Pad Sensitivity:** (1 - 12)

There are 12 sensitivity levels for Tetrapad, numbered 1-12. Higher numbers are more sensitive to the touch of your finger but slightly less sensitive to its position, while lower numbers are less sensitive to touch, but more sensitive to position. Touch sensitivity has the most obvious effect in highly-reactive modes, like, where the way in which you touch a fader has the most effect on the CV values it transmits. Tetrapad ships with a default value level of 7.

- **Late Comp.:** (On, Off)

When clocking Tête externally, turning ON Late Compensation allows Tête to handle any incoming variations in externally arriving signals, keeping everything perfectly synced.

However, if you're running Tête from its internal clock, but driving external modules from it, you may achieve even tighter synchronization by turning OFF the Late Compensation setting.

- **Tête Version**

Displays Tête's current firmware version.

- **Tetrapad Version**

Displays the version number of a connected Tetrapad.

If your Tetrapad is not connected, or if it's running a firmware version prior to 3.0, then the Tetrapad Version will be displayed as: X.X.X.X

System Mode

System Mode (accessed by selecting and pressing the Tête Version display in the Global Setup Menu) contains various housekeeping, test, and maintenance features. These modes are meant for use at Intellijel, and will likely never need to be used. These are:

- **Calibration** : See [Calibrating Tête](#) for detailed instructions.
- **File Browser** : Can be used to browse the file system and delete files.
- **Format Card** : Will format and erase the microSD card.
- **SD Test (Destructive)** : Speed tests for your microSD card, *it will erase your microSD card*
- **Test Mode** : Used to Test LEDs and Jacks.
- **Reboot** : Reboots the module

CV Setup Menu

Tête features three user-assignable output jacks and five user-assignable input jacks. User assignments are made in Tête's CV Setup Menu, which is accessed by pressing the **CV FILE** button to the right of Tête's screen encoder.

Each mode (Combo, Notes, Voltages) has its own CV Settings.

To select and assign CV (and gate/triggers) to Tête's input/output jacks:

1. Select the desired Mode of operation (Combo, Notes, Voltages).
2. Short-press (<1 sec) the **CV FILE** button (to the right of Tête's Screen) to view and edit Tête's input and output CV settings for that Mode.

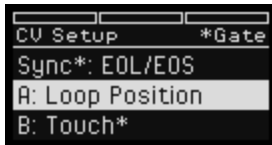

3. Select the setting you wish to edit by rotating Tête's Screen Encoder.
4. Press the Screen Encoder to highlight the function currently assigned to that setting.
5. Rotate the Screen Encoder to change the assignment.
6. Press the Screen Encoder to exit editing, then repeat steps 2-4 to edit other assignments.
7. Press the **CV FILE** button to exit the CV Settings screen.

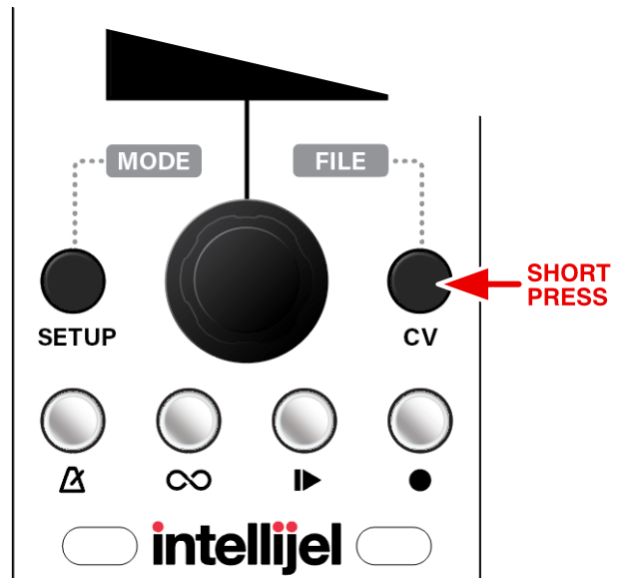

The following sections lists all the CV Setup options for all the various modes.

NOTE: Gates and triggers are indicated by an asterisk () to the right of the I/O or function name, while continuous voltages have no such asterisk.*

IMPORTANT: In Voltages Mode, all trigger () based bank modulations happen before the looper/sequencer data is processed and will be overridden by playback. All continuous CV-based modulation happens after any recorded Looper or Sequencer data plays, and is stacked/offset on top of that playback data.*

CV Setup: SYNC Output

Assign a function to Tête's **SYNC** output jack using the “Sync” setting in Tête's CV Settings Menu. The options are as follows:

- **- (off)** : No signal is sent out the **SYNC** jack.
- **Clock** : Outputs a +5V clock pulse regardless of whether or not a loop or sequence is currently playing back. The clock signal being output is determined by Tête's clock settings (i.e., either ‘internally’ generated at the prescribed value, or externally synchronized through the **CLK** input jack).
- **Run Clock** : Outputs a +5V clock pulse only when a loop or sequence is currently playing back. The clock signal being output is determined by Tête's clock settings (i.e., either ‘internally’ generated at the prescribed value, or externally synchronized through the **CLK** input jack).
- **Touch Clock** : Outputs a +5V clock pulse only when one of Tetrapad's four pads is currently being touched. The clock signal is output regardless of whether or not the loop or sequence is currently playing back. The clock signal being output is determined by Tête's clock settings (i.e., either ‘internally’ generated at the prescribed value, or externally synchronized through the **CLK** input jack).
- **Play** : Outputs a +5V trigger pulse whenever the **PLAY (▶)** button starts Sequence or Looper playback.
- **Stop** : Outputs a +5V trigger pulse whenever Sequencer or Looper playback is stopped by long-pressing the **PLAY (▶)** button.

Note: Short-pressing (<1 sec) the **PLAY (▶)** button only *pauses* playback; long-pressing it *stops* playback and returns the “playhead” to the beginning of the recording).

- **Run** : Outputs a +5V gate whenever Tête is playing back a loop or sequence. The gate remains high for as long as the loop/sequence is running.
- **EOL/EOS** : Outputs a +5V trigger at the end of the currently playing loop or sequence.
- **SOL/SOS** : Outputs a +5V trigger at the start of the currently playing loop or sequence.
- **Touch** : Outputs a +5V gate whenever any of Tetrapad's four pads is touched.
- **Touch 1 - Touch 4** : (Combo Mode Only) Transmits a +5V gate whenever the indicated pad is touched.
- **Run+Rec** : Outputs a +5V gate whenever Tête is actively recording or overdubbing a loop or sequence.
- **Loopy** : Outputs a +5V gate whenever Loopy is active.

NOTE: For more information about Tête's clocking features, see [TEMPO Menu](#).

CV Setup: Output A

Assign a function to Tête's **A** output jack using the "A" setting in Tête's CV Settings Menu. The options are as follows:

- **(off)** : No signal is sent out the **A** jack.
- **Clock*** : Outputs a +5V clock pulse regardless of whether or not a loop or sequence is currently playing back. The clock signal being output is determined by Tête's clock settings (i.e., either 'internally' generated at the prescribed value, or externally synchronized through the **SYNC INPUT** jack). For more information about Tête's clocking features, see [TEMPO Menu](#).
- **Run Clock*** : Outputs a +5V clock pulse only when a loop or sequence is currently playing back. The clock signal being output is determined by Tête's clock settings (i.e., either 'internally' generated at the prescribed value, or externally synchronized through the **CLK** input jack).
- **Touch Clock*** : Outputs a +5V clock pulse only when one of Tetrapad's four pads is currently being touched. The clock signal is output regardless of whether or not the loop or sequence is currently playing back. The clock signal being output is determined by Tête's clock settings (i.e., either 'internally' generated at the prescribed value, or externally synchronized through the **CLK** input jack).
- **Play*** : Outputs a +5V trigger pulse whenever the **PLAY (▶)** button starts Sequence or Looper playback.
- **Stop*** : Outputs a +5V trigger pulse whenever Sequencer or Looper playback is stopped by long-pressing the **PLAY (▶)** button.

Note: Short-pressing (<1 sec) the **PLAY (▶)** button only *pauses* playback; long-pressing it *stops* playback and returns the "playhead" to the beginning of the recording).

- **Run*** : Outputs a +5V gate whenever Tête is playing back a loop or sequence. The gate remains high for as long as the loop/sequence is running.
- **EOL/EOS*** : Outputs a +5V trigger at the end of the currently playing loop or sequence.
- **SOL/SOS*** : Outputs a +5V trigger at the start of the currently playing loop or sequence.
- **Touch*** : Outputs a +5V gate whenever any of Tetrapad's four pads is touched.
- **Touch 1* - Touch 4*** : (Combo Mode Only) Transmits a +5V gate whenever the indicated pad is touched.
- **Pressure 1 - Pressure 4** : (Combo Mode Only) Transmits a control voltage based on the amount of pressure applied to the indicated pad.

- **Loop Position** : Outputs a voltage that rises steadily from 0V (at the beginning of a loop or sequence) to +5V at the very end of the currently playing loop/sequence.
- **Run+Rec*** : Outputs a +5V gate whenever Tête is actively recording or overdubbing a loop or sequence.
- **Loopy*** : Outputs a +5V gate whenever Loopy is active.

CV Setup: Output B

Assign a function to Tête's **B** output jack using the "B" setting in Tête's CV Settings Menu. The options for output B are identical to those for output A, as discussed above.

CV Setup: TRIG and RESET Inputs

Assign functions to Tête's **TRIG** and **RESET** input jacks using the "Trig" and "Reset" settings in Tête's CV Settings Menu. The assignment options for both inputs are identical. The following assignment descriptions apply to the TRIG input, but the same options are available for the RESET input:

- **- (off)** : Any signal patched into the **TRIG** jack is ignored.
- **Reset** : An input trigger patched into the **TRIG** jack causes the current loop/sequence to reset to the beginning.
- **Run** : A +5V gate is required in order for the current Sequence or Loop to play. Tête must be in a play state (the **PLAY (▶)** button is solid green) in order for the Run feature to work. A sequence/loop will run for as long as a +5V signal appears at the jack, and will pause when the signal drops back to 0V.
- **Mod Trig** : An input trigger patched into the **TRIG** jack is used by any X, Y, or Z CV input that's set to sample the incoming CV whenever a (Trig) input is received.

This is the **TRIG** jack's default setting.

For example, if you assign **CV Z** to "**Slew (Trig)**" in the Notes Mode CV Setup Menu, then the CV changes at the **Z** input are sampled and held each time a rising edge signal appears at the TRIG jack — but only if the TRIG Input is assigned to "**Mod Trig**".

- **Looper** : With this assignment, Tête's Looper uses the **TRIG** input to define a loop's start time and length (rather than using the internal or external clock). In addition, this assignment redefines **Loop Length** (as set in the Mode Setup menu) as the "number of pulses on the TRIG inputs," rather than the "number of clocks pulses."

In general, this lets you trigger Loop recordings that conform to "bars," rather than "beats."

- **Tggl Loopy** : An input trigger patched into the **TRIG** jack toggles [Loopy](#) on/off.
- **Gate Loopy** : An input gate patched into the **TRIG** jack turns [Loopy](#) on/off. When the gate is high, Loopy is on. When the gate is off, Loopy is off.

In Voltages Mode, Tête offers these additional CV assignments:

- **Bank Rand*** : An input trigger patched into the **TRIG** jack selects a random voltage bank.
- **Bank Fwd*** : An input trigger patched into the **TRIG** jack selects the next higher-numbered voltage bank.

For example, if Voltage Bank 5 is the current bank, then an input trigger will select Voltage Bank 6 — sending Bank 6’s voltage values to the eight outputs, and changing the active bank display on Tetrapad (which numbers Voltage Banks as shown below):

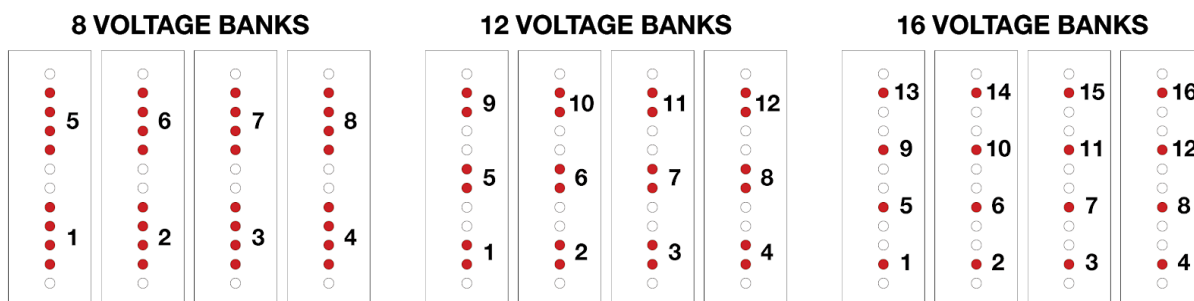

- **Bank Rev*** : An input trigger patched into the **TRIG** jack selects the next lower-numbered voltage bank. For example, if Voltage Bank 3 is the current bank, then an input trigger will select Voltage Bank 2 — sending Bank 2’s voltage values to the eight outputs, and changing the active bank display on Tetrapad (which numbers Voltage Banks as shown above).
- **Bank X*** : An input trigger patched into the **TRIG** jack selects the voltage bank immediately to the right of the current bank (moving along the X-axis). Once you reach the far-right bank of the X-axis, the next trigger will cause the bank select to “wrap around” to the beginning (far left) of the X-axis. For example, if Voltage Bank 7 is the active bank, then the first trigger will select Bank 8, and the next trigger will select Bank 5.
- **Bank Y*** : An input trigger patched into the **TRIG** jack selects the voltage bank immediately above the current bank (moving along the Y-axis).

Once you reach the top of the Y-axis, the next trigger will cause the bank select to “wrap around” to the bottom of the Y-axis.

For example (assuming you use 16 Banks): if Voltage Bank 11 is the current bank, then the first trigger will select Voltage Bank 15 (the bank immediately above Bank 11, as shown in the Voltage Bank numbering display, above), and the next trigger will select Bank 3.

CV Setup: RESET Input

Assign a function to Tête’s **RESET** input jack using the “Reset” setting in Tête’s CV Settings Menu. The options for the **RESET** jack are identical to those for the **TRIG** Input jack, as discussed above.

*NOTE: The **RESET** input jack is assigned to the “Reset” function in all modes by default.*

CV Setup: Input X, Y and Z (Notes Mode)

The CV Setup menu changes somewhat depending on whether Tête/Tetrapad is operating in Combo, Notes, or Voltages mode. This section discusses the CV setup options that are available when you're using Notes Mode.

At the top of the CV Setup menu are three voltage display bars. These display graphically the X, Y and Z CV voltages (post Tête's attenuverters). Bars extending to the right of center indicate positive CV, while bars extending to the left of center indicate negative CV.

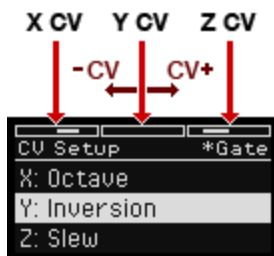

Use these CV meters along with Tête's associated X, Y and Z attenuverters to modify and monitor the voltage being sent through to the assigned destination. Tête's CV inputs will read sources of up to $\pm 10V$, but only $\pm 5V$ is needed to sweep the full range of the input, so you can use the attenuverters and CV meters to dial down extreme input voltages. Note that attenuverters are ignored for any CV assignments that read 1 V/oct.

The following options are available for X, Y and Z assignment in Notes Mode:

- **- (off)** : Any signal patched into the corresponding CV input jack is ignored.
- **Reset*** : An input trigger patched into the corresponding CV input jack causes the current loop/sequence to reset to the beginning.
- **Run*** : A +5V gate is required in order for the current Sequence or Loop to play. Tête must be in a play state (the **PLAY (▶)** button is solid green) in order for the Run feature to work. A sequence/loop will run for as long as a +5V signal appears at the jack, and will pause when the signal drops back to 0V.
- **Looper*** : With this assignment, Tête's Looper uses the **TRIG** input to define a loop's start time and length (rather than using the internal or external clock). In addition, this assignment redefines **Loop Length** (as set in the Mode Setup menu) as the "number of pulses on the TRIG inputs," rather than the "number of clocks pulses."
- **Tggl Loopy*** : An input trigger patched into the corresponding CV input jack toggles [Loopy](#) on/off.
- **Gate Loopy*** : An input gate patched into the corresponding CV input jack turns [Loopy](#) on/off. When the gate is high, Loopy is on. When the gate is off, Loopy is off.

-
- **Loopy Length** : If the [Loopy](#) feature is engaged, then a CV patched into the assigned jack will modify the Loopy length. At 0V, Loopy is set to its minimum length. At +5V, Loopy plays at its maximum length. Values in between scale the Loopy Length accordingly.
 - **Loopy Shift** : If the [Loopy](#) feature is engaged, then a CV patched into the assigned jack will shift Loopy's start point forward or backward. Positive voltages shift Loopy's start point later in the recording (wrapping around to the beginning when you shift Loopy's start point past the end of the recording). Negative voltages shift Loopy's start point earlier in the recording (wrapping around to the end when you shift Loopy's start point past the beginning of the recording).
 - **Slew** : CV input continuously controls the Slew rate. Positive voltages increase the slew from its current amount. Negative voltages decrease it. Note that you cannot set slew rates less than 'instantaneous' nor can you set slew rates longer than those available on Tetrapad itself.
 - **Slew (CLK)** : Similar to the **Slew** option, except CV control is not continuous. Rather, the incoming CV is sampled by the clock (using either the internal clock or an external clock patched into Tête's **CLK** input), and is held until the next clock. This enables you to synchronize slew rate changes to a clock.
 - **Slew (Trig)** : Similar to the **Slew** option, except CV control is not continuous. Rather, the incoming CV is sampled on the leading edge of any signal patched into an input (**RESET** or **TRIG**) that's assigned to the "**Mod Trig**" function in the CV Setup Menu. It is then held until the next trigger. This enables you to synchronize slew rate changes to an external trigger source.
 - **Slew (Pad)** : Similar to the **Slew** option, except CV control is not continuous. Rather, the incoming CV is sampled each time you touch a pad, and is held until the next touch. This enables you to synchronize slew rate changes to touches on Tetrapad's virtual keyboard.
 - **Semitone** : CV input shifts pitch up or down in semitones, with positive voltages increasing the pitch and negative voltages decreasing it. CV inputs assigned to this function ignore the corresponding attenuverter, and track 1V/oct (meaning the semitones change every .083 V). You can use CV to raise the pitch (in semitones) as high as C5 (at which point the CV input is ignored), or you can lower the pitch to as low as C-5. Semitone changes happen *before* any additional octave shift or inversion. Modulation to Semitones will not be reflected on the Tête's display.
 - **Semitone (CLK)** : Similar to the **Semitone** option, except CV control is not continuous. Rather, the incoming CV is sampled by the clock (using either the internal clock or an external clock patched into Tête's **CLK** input), and is held until the next clock. This enables you to synchronize semitone changes to a clock.
 - **Semitone (TRG)** : Similar to the **Semitone** option, except CV control is not continuous. Rather, the incoming CV is sampled on the leading edge of any signal patched into an input (**RESET** or **TRIG**) that's assigned to the "**Mod Trig**" function in the CV Setup Menu. It is then
-

held until the next trigger. This enables you to synchronize semitone changes to an external trigger source.

- **Semitone (PAD)** : Similar to the **Semitone** option, except CV control is not continuous. Rather, the incoming CV is sampled each time you touch a pad, and is held until the next touch. This enables you to synchronize semitone changes to touches on Tetrapad's virtual keyboard.
- **Octave** : CV input continuously controls the octave range of Tetrapad's virtual keyboard. Each +1V signal raises the pitch of all Tetrapad notes by 1 octave. Negative voltages lower the current octave in 1V increments. Modulation to Octaves will not be reflected on the Tête's display.
- **Octave (CLK)** : Similar to the **Octave** option, except CV control is not continuous. Rather, the incoming CV is sampled by the clock (using either the internal clock or an external clock patched into Tête's **CLK** input), and is held until the next clock. This enables you to synchronize octave changes to a clock.
- **Octave (Trig)** : Similar to the **Octave** option, except CV control is not continuous. Rather, the incoming CV is sampled on the leading edge of any signal patched into an input (**RESET** or **TRIG**) that's assigned to the "**Mod Trig**" function in the CV Setup Menu. It is then held until the next trigger. This enables you to synchronize octave changes to an external trigger source.
- **Octave (Pad)** : Similar to the **Octave** option, except CV control is not continuous. Rather, the incoming CV is sampled each time you touch a pad, and is held until the next touch. This enables you to synchronize octave changes to touches on Tetrapad's virtual keyboard.
- **Rotate** : CV input continuously rotates output assignment.

At approximately every +1.25V, the output assignments shift to the right by 1. So if you send 1.25V into the CV input, the note originally assigned to Out 1 will appear at Out 2; Out 2's note appears at Out 3; Out 3's original note appears at Out 4; and Out 4's original note now appears at Out 1.

Send in +2.5V, and Out 1's original pitch rotates to Out 3 (2-steps to the right), and all the other Outputs rotate accordingly. Send in +3.75V and Out 1's original pitch rotates to Out 4 (3-steps to the right); and all the other outputs rotate accordingly.

NOTE: On Tetrapad, the brightest of the four blue Output Status LEDs indicates which output is currently playing the note that was originally assigned to Out 1. On Tête, the boldest note indicator reflects this.

- **Rotate (CLK)** : Similar to the **Rotate** option, except CV control is not continuous. Rather, the incoming CV is sampled by the clock (using either the internal clock or an external clock patched into Tête's **CLK** input), and is held until the next clock. This enables you to synchronize rotations to a clock.

- **Rotate (Trig)** : Similar to the **Rotate** option, except CV control is not continuous. Rather, the incoming CV is sampled on the leading edge of any signal patched into an input (**RESET** or **TRIG**) that's assigned to the "**Mod Trig**" function in the CV Setup Menu. It is then held until the next trigger. This enables you to synchronize rotations to an external trigger source.
- **Rotate (Pad)** : Similar to the **Rotate** option, except CV control is not continuous. Rather, the incoming CV is sampled each time you touch a pad, and is held until the next touch. This enables you to synchronize rotations to touches on Tetrapad's virtual keyboard.
- **Inversion** : Inversion looks at the four outputs as if they formed a chord, and CV input inverts the "chord" played by the 4 outputs. At approximately every +1.25V, the "chord" inverts. So if you send 1.25V into the CV input, Out 1 transposes up one octave. If you send 2.5V into the CV input, Out 2 transposes up one octave, and if you send 3.75V, Out 3 transposes up an octave.
- **Inversion (CLK)** : Similar to the **Inversion** option, except CV control is not continuous. Rather, the incoming CV is sampled by the clock (using either the internal clock or an external clock patched into Tête's **CLK** input), and is held until the next clock. This enables you to synchronize inversions to a clock.
- **Inversion (Trig)** : Similar to the **Inversion** option, except CV control is not continuous. Rather, the incoming CV is sampled on the leading edge of any signal patched into an input (**RESET** or **TRIG**) that's assigned to the "**Mod Trig**" function in the CV Setup Menu. It is then held until the next trigger. This enables you to synchronize inversions to an external trigger source.
- **Inversion (Pad)** : Similar to the **Inversion** option, except CV control is not continuous. Rather, the incoming CV is sampled each time you touch a pad, and is held until the next touch. This enables you to synchronize inversions to touches on Tetrapad's virtual keyboard.

CV Setup: Input X, Y and Z (Voltages Mode)

The CV Setup menu changes somewhat depending on whether Tête/Tetrapad is operating in Combo, Notes, or Voltages mode. This section discusses the CV setup options that are available when you're using Voltages Mode.

At the top of the CV Setup menu are three voltage display bars. These display graphically the X, Y and Z CV voltages (post Tête's attenuverters). Bars extending to the right of center indicate positive CV, while bars extending to the left of center indicate negative CV.

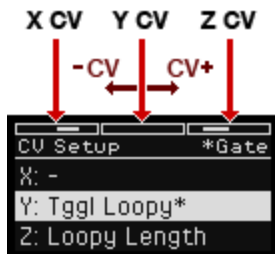

Use these CV meters along with Tête's associated X, Y and Z attenuverters to modify and monitor the voltage being sent through to the assigned destination. Tête's CV inputs will read sources of up to $\pm 10V$, but only $\pm 5V$ is needed to sweep the full range of the input, so you can use the attenuverters and CV meters to dial down extreme input voltages. Note that attenuverters are ignored for any CV assignments that read 1 V/oct.

The following options are available for X, Y and Z assignment in Voltages Mode:

- **- (off)** : Any signal patched into the corresponding CV input jack is ignored.
- **Reset*** : An input trigger patched into the corresponding CV input jack causes the current loop/sequence to reset to the beginning.
- **Run*** : A +5V gate is required in order for the current Sequence or Loop to play. Tête must be in a play state (the **PLAY (▶)** button is solid green) in order for the Run feature to work. A sequence/loop will run for as long as a +5V signal appears at the jack, and will pause when the signal drops back to 0V.
- **Looper*** : With this assignment, Tête's Looper uses the **TRIG** input to define a loop's start time and length (rather than using the internal or external clock). In addition, this assignment redefines **Loop Length** (as set in the Mode Setup menu) as the "number of pulses on the TRIG inputs," rather than the "number of clocks pulses."
- **Tggl Loopy*** : An input trigger patched into the corresponding CV input jack toggles [Loopy](#) on/off.
- **Gate Loopy*** : An input gate patched into the corresponding CV input jack turns [Loopy](#) on/off. When the gate is high, Loopy is on. When the gate is off, Loopy is off.

-
- **Loopy Length** : If the [Loopy](#) feature is engaged, then a CV patched into the assigned jack will modify the Loopy length. At 0V, Loopy is set to its minimum length. At +5V, Loopy plays at its maximum length. Values in between scale the Loopy Length accordingly.
 - **Loopy Shift** : If the [Loopy](#) feature is engaged, then a CV patched into the assigned jack will shift Loopy's start point forward or backward. Positive voltages shift Loopy's start point later in the recording (wrapping around to the beginning when you shift Loopy's start point past the end of the recording). Negative voltages shift Loopy's start point earlier in the recording (wrapping around to the end when you shift Loopy's start point past the beginning of the recording).
 - **Slew** : CV input continuously controls the Slew rate. Positive voltages increase the slew from its current amount. Negative voltages decrease it. Note that you cannot set slew rates less than 'instantaneous' nor can you set slew rates longer than those available on Tetrapad itself.
 - **Slew (CLK)** : Similar to the **Slew** option, except CV control is not continuous. Rather, the incoming CV is sampled by the clock (using either the internal clock or an external clock patched into Tête's **CLK** input), and is held until the next clock. This enables you to synchronize slew rate changes to a clock.
 - **Slew (Trig)** : Similar to the **Slew** option, except CV control is not continuous. Rather, the incoming CV is sampled on the leading edge of any signal patched into an input (**RESET** or **TRIG**) that's assigned to the "Mod Trig" function in the CV Setup Menu. It is then held until the next trigger. This enables you to synchronize slew rate changes to an external trigger source.
 - **Slew (Pad)** : Similar to the **Slew** option, except CV control is not continuous. Rather, the incoming CV is sampled each time you touch a pad, and is held until the next touch. This enables you to synchronize slew rate changes to touches on Tetrapad's pads.
 - **Level** : Uses the CV input to continuously scale the stored voltage values.

In this case, incoming CV acts as a multiplier. At +5 V, 100% of the stored voltage is sent to the output. At 2.5V, 50% of the stored voltage is sent to the output. At 0V, 0% of the stored voltage is sent to the output. Negative voltages scale and invert the stored voltages.

NOTE: If the input CV is 0V, then you will get no output voltages from your Tetrapad (since 0V means you transmit 0% of your stored value). So if you select this option, you'll definitely need to patch a CV source into the input.

- **Level (CLK)** : Similar to the **Level** option, except CV control is not continuous. Rather, the incoming CV is sampled by the clock (using either the internal clock or an external clock patched into Tête's **CLK** input), and is held until the next clock. This enables you to synchronize level changes to a clock.
- **Level (Trig)** : Similar to the **Level** option, except CV control is not continuous. Rather, the incoming CV is sampled on the leading edge of any signal patched into an input (**RESET** or

TRIG) that's assigned to the "**Mod Trig**" function in the CV Setup Menu. It is then held until the next trigger. This enables you to synchronize level changes to an external trigger source.

- **Level (Pad)** : Similar to the **Level** option, except CV control is not continuous. Rather, the incoming CV is sampled each time you touch a pad, and is held until the next touch. This enables you to synchronize level changes to touches on Tetrapad's pads.
- **Offset** : Continuously adds the value at the CV input to the stored voltage values.

For example, assume the current bank sends 2V to Out 1 and -3V to Out 2. If you send 1V into the CV input, then 3V (2V + 1V) appears at Out 1 and -2V (-3V + 1V) at Out 2.

NOTE: Tetrapad's output voltages are capped at $\pm 5V$, so you if your stored voltage + the input CV voltage adds up to more than 5V, only 5V will be sent to the Tetrapad output.

- **Offset (CLK)** : Similar to the **Offset** option, except CV control is not continuous. Rather, the incoming CV is sampled by the clock (using either the internal clock or an external clock patched into Tête's **CLK** input), and is held until the next clock. This enables you to synchronize offsets to a clock.
- **Offset (Trig)** : Similar to the **Offset** option, except CV control is not continuous. Rather, the incoming CV is sampled on the leading edge of any signal patched into an input (**RESET** or **TRIG**) that's assigned to the "**Mod Trig**" function in the CV Setup Menu. It is then held until the next trigger. This enables you to synchronize offsets to an external trigger source.
- **Offset (Pad)** : Similar to the **Offset** option, except CV control is not continuous. Rather, the incoming CV is sampled each time you touch a pad, and is held until the next touch. This enables you to synchronize offsets to touches on Tetrapad's pads.
- **Scale Root** : If you're using Quantized voltages, then the CV input changes the root of the scale you selected in the [Voltages Mode SETUP Menu](#).
- **Scale Root (CLK)** : Similar to the **Scale Root** option, except CV control is not continuous. Rather, the incoming CV is sampled by the clock (using either the internal clock or an external clock patched into Tête's **CLK** input), and is held until the next clock. This enables you to synchronize scale root changes to a clock.
- **Scale Root (Trig)** : Similar to the **Scale Root** option, except CV control is not continuous. Rather, the incoming CV is sampled on the leading edge of any signal patched into an input (**RESET** or **TRIG**) that's assigned to the "**Mod Trig**" function in the CV Setup Menu. It is then held until the next trigger. This enables you to synchronize scale root changes to an external trigger source.
- **Scale Root (Pad)** : Similar to the **Scale Root** option, except CV control is not continuous. Rather, the incoming CV is sampled each time you touch a pad, and is held until the next touch. This enables you to synchronize scale root changes to touches on Tetrapad's pads.

- **Bank Rand*** : A trigger patched into the corresponding CV input jack selects a random voltage bank.
- **Bank Fwd*** : A trigger patched into the corresponding CV input jack selects the next higher-numbered voltage bank.

For example, if Voltage Bank 5 is the current bank, then an input trigger will select Voltage Bank 6 — sending Bank 6’s voltage values to the eight outputs, and changing the active bank display on Tetrapad (which numbers Voltage Banks as shown below):

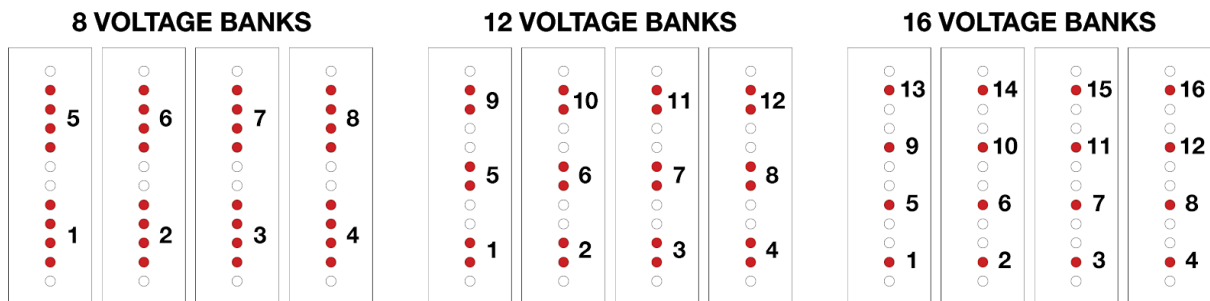

- **Bank Rev*** : A trigger patched into the corresponding CV input jack selects the next lower-numbered voltage bank.

For example, if Voltage Bank 3 is the current bank, then an input trigger will select Voltage Bank 2 — sending Bank 2’s voltage values to the eight outputs, and changing the active bank display on Tetrapad (which numbers Voltage Banks as shown above).

- **Bank X*** : A trigger patched into the corresponding CV input jack selects the voltage bank immediately to the right of the current bank (moving along the X-axis).

Once you reach the far-right bank of the X-axis, the next trigger will cause the bank select to “wrap around” to the beginning (far left) of the X-axis. For example, if Voltage Bank 7 is the active bank, then the first trigger will select Bank 8, and the next trigger will select Bank 5.

- **Bank Y*** : A trigger patched into the corresponding CV input jack selects the voltage bank immediately above the current bank (moving along the Y-axis).

Once you reach the top of the Y-axis, the next trigger will cause the bank select to “wrap around” to the bottom of the Y-axis.

For example (assuming you use 16 Banks): if Voltage Bank 11 is the current bank, then the first trigger will select Voltage Bank 15 (the bank immediately above Bank 11, as shown in the Voltage Bank numbering display, above), and the next trigger will select Bank 3.

- **Bank CV** : CV Offsets Current/Played Position linearly.

With this assignment, you can use the **Bank CV** to directly select any available voltage bank.

For example, assume you have Tetrapad configured for 16 Voltage Banks. Positive voltages will select bank numbers higher than the current bank (roughly one every 1/3 Volt when 16 Banks are used). Once the highest bank number is reached (16 in this example), the next voltage increase will wrap the bank selection around to Bank 1. Negative voltages, as you would expect, select lower numbered banks — also wrapping (to Bank 16) once Bank 1 is reached.

- **Bank CV (CLK)** : Similar to the **Bank CV** option, except CV control is not continuous. Rather, the incoming CV is sampled by the clock (using either the internal clock or an external clock patched into Tête’s **CLK** input), and is held until the next clock. This enables you to synchronize bank changes to a clock.
- **Bank CV (Trig)** : Similar to the **Bank CV** option, except CV control is not continuous. Rather, the incoming CV is sampled on the leading edge of any signal patched into an input (**RESET** or **TRIG**) that’s assigned to the “**Mod Trig**” function in the CV Setup Menu. It is then held until the next trigger. This enables you to synchronize bank changes to an external trigger source.
- **Bank CV (Pad)** : Similar to the **Bank CV** option, except CV control is not continuous. Rather, the incoming CV is sampled each time you touch a pad, and is held until the next touch. This enables you to synchronize bank changes to touches on Tetrapad’s pads.
- **Bank X CV** : CV Offsets Current/Played Position on the X Axis.

Banks are arranged within a grid. The number of banks determines the size of the grid. Specifically:

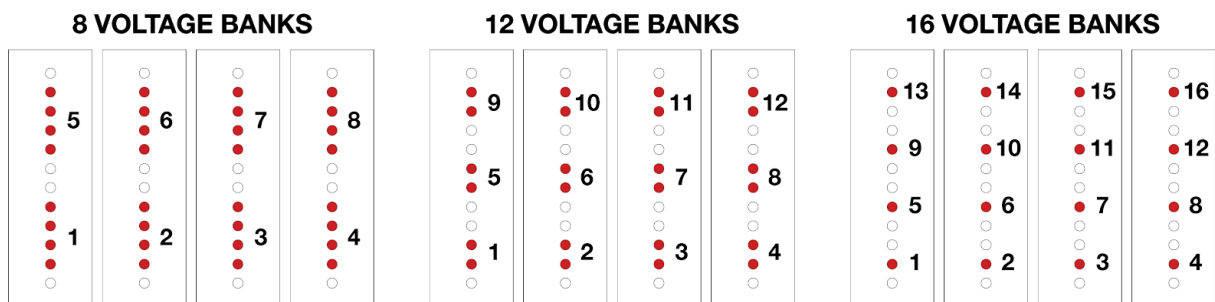

With this assignment, you can use the **Bank X CV** to select between four different voltage banks along the current bank’s row.

For example, if Bank 6 is current and you send positive control voltages to the CV input, they’ll first select Bank 7, then Bank 8, and then wrap back around to Bank 5. At this point, bank

selection will stop since you will have scrolled through all options on the X-axis. Negative voltages select banks to the left of the current one, wrapping accordingly.

- Bank X CV (CLK)** : Similar to the **Bank X CV** option, except CV control is not continuous. Rather, the incoming CV is sampled by the clock (using either the internal clock or an external clock patched into Tête’s **CLK** input), and is held until the next clock. This enables you to synchronize X-axis bank changes to a clock.
- Bank X CV (Trig)** : Similar to the **Bank X CV** option, except CV control is not continuous. Rather, the incoming CV is sampled on the leading edge of any signal patched into an input (**RESET** or **TRIG**) that’s assigned to the “**Mod Trig**” function in the CV Setup Menu. It is then held until the next trigger. This enables you to synchronize X-axis bank changes to an external trigger source.
- Bank X CV (Pad)** : Similar to the **Bank X CV** option, except CV control is not continuous. Rather, the incoming CV is sampled each time you touch a pad, and is held until the next touch. This enables you to synchronize X-axis bank changes to touches on Tetrapad’s pads.
- Bank Y CV** : CV Offsets Current/Played Position on the Y Axis

Banks are arranged within a grid. The number of banks determines the size of the grid. Specifically:

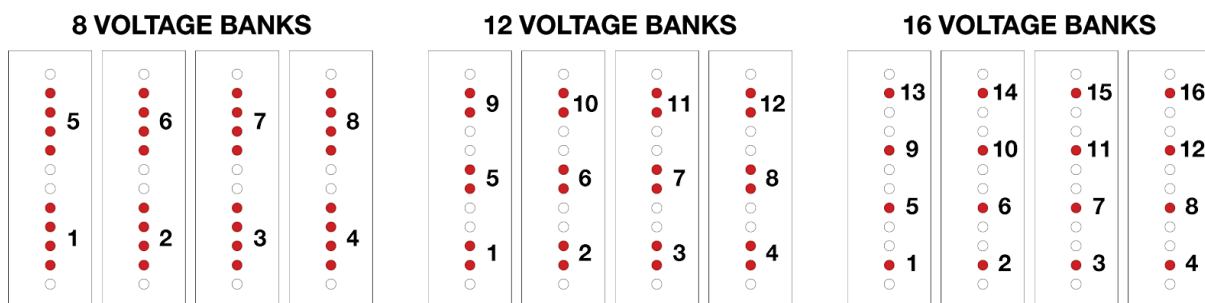

With this assignment, you can use the **Bank Y CV** to select between either two, three or four different voltage banks along the current bank’s column (the number of selectable banks depends on whether you’re configured Tetrapad to access 8, 12 or 16 voltage banks, as shown above).

For example (assuming you use 16 Banks): If Bank 6 is current and you send positive control voltages to the CV input, they’ll first select Bank 10, then Bank 14, and then wrap back around to Bank 2. At this point, bank selection will stop since you will have scrolled through all options on the Y-axis. Negative voltages select banks below the current one, wrapping accordingly.

- **Bank Y CV (CLK)** : Similar to the **Bank Y CV** option, except CV control is not continuous. Rather, the incoming CV is sampled by the clock (using either the internal clock or an external clock patched into Tête's **CLK** input), and is held until the next clock. This enables you to synchronize Y-axis bank changes to a clock.
- **Bank Y CV (Trig)** : Similar to the **Bank Y CV** option, except CV control is not continuous. Rather, the incoming CV is sampled on the leading edge of any signal patched into an input (**RESET** or **TRIG**) that's assigned to the "**Mod Trig**" function in the CV Setup Menu. It is then held until the next trigger. This enables you to synchronize Y-axis bank changes to an external trigger source.
- **Bank Y CV (Pad)** : Similar to the **Bank Y CV** option, except CV control is not continuous. Rather, the incoming CV is sampled on the leading edge of any signal patched into an input (**RESET** or **TRIG**) that's assigned to the "**Mod Trig**" function in the CV Setup Menu. It is then held until the next trigger. This enables you to synchronize Y-axis bank changes to an external trigger source.

CV Setup: Input X, Y and Z (Combo Mode)

The CV Setup menu changes somewhat depending on whether Tête/Tetrapad is operating in Combo, Notes, or Voltages mode. This section discusses the X, Y and Z CV setup options that are available when you're using Combo Mode.

At the top of the CV Setup menu are three voltage display bars. These display graphically the X, Y and Z CV voltages (post Tête's attenuverters). Bars extending to the right of center indicate positive CV, while bars extending to the left of center indicate negative CV.

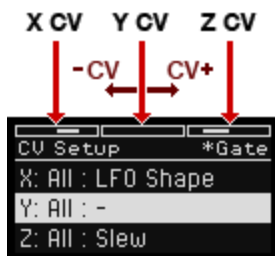

Use these CV meters along with Tête's associated X, Y and Z attenuverters to modify and monitor the voltage being sent through to the assigned destination. Tête's CV inputs will read sources of up to $\pm 10V$, but only $\pm 5V$ is needed to sweep the full range of the input, so you can use the attenuverters and CV meters to dial down extreme input voltages. Note that attenuverters are ignored for any CV assignments that read 1 V/oct.

In **Combo Mode**, each of Tetrapad's four pads operates independently, so you have the option of allowing an input to control ALL four pads on Tetrapad, or a subset of the four pads (meaning some pads can be made to ignore the X, Y or Z input).

To assign a function to a specific pad (or group of pads):

1. With the CV Setup menu visible, rotate Tête's Screen Encoder to select the X, Y or Z entry.
2. Press the Screen Encoder to highlight the Pad assignment field immediately to the right of the X, Y or Z label.
3. Rotate the Screen Encoder to select which of Tetrapad's four pads will be affected by the input. The choices are:

ALL, 1, 2, 3, 4, 1+2, 2+3, 3+4, 1+2+3, and 2+3+4

4. Press the Screen Encoder again to highlight the name of the function currently assigned to the Input for the previously selected Pads.

At this point CV setup works normally. That is, rotate Tête's Screen Encoder to select which CV you wish to associate with the X, Y or Z input.

The assignment choices for Inputs X, Y and Z are as follows:

- **- (off)** : Any signal patched into the corresponding CV input jack is ignored.
- **Reset*** : An input trigger patched into the corresponding CV input jack causes the current loop to reset to the beginning.
- **Run*** : A +5V gate is required in order for the current Loop to play. Tête must be in a play state (the **PLAY (▶)** button is solid green) in order for the Run feature to work. A loop will run for as long as a +5V signal appears at the jack, and will pause when the signal drops back to 0V.
- **Looper*** : With this assignment, Tête's Looper looks to the corresponding CV input to define a loop's start time and length (rather than using the internal or external clock). In addition, this assignment redefines **Loop Length** (as set in the Mode Setup menu) as the "number of cycles between TRIG inputs," rather than the "number of cycles between clocks."
- **Tggl Loopy*** : An input trigger patched into the corresponding CV input jack toggles [Loopy](#) playback on/off.
- **Gate Loopy*** : An input gate patched into the corresponding CV input jack turns [Loopy](#) on/off. When the gate is high, Loopy is on. When the gate is off, Loopy is off.
- **Loopy Length** : If the [Loopy](#) feature is engaged, then a CV patched into the assigned jack will modify the Loopy length. At 0V, Loopy is set to its minimum length. At +5V, Loopy plays at its maximum length. Values in between scale the Loopy Length accordingly.
- **Loopy Shift** : If the [Loopy](#) feature is engaged, then a CV patched into the assigned jack will shift Loopy's start point forward or backward. Positive voltages shift Loopy's start point later in the recording (wrapping around to the beginning when you shift Loopy's start point past the end of the recording). Negative voltages shift Loopy's start point earlier in the recording (wrapping around to the end when you shift Loopy's start point past the beginning of the recording).
- **Slew** : CV input continuously controls the Slew rate. Positive voltages increase the slew from its current amount. Negative voltages decrease it. Note that you cannot set slew rates less than 'instantaneous' nor can you set slew rates longer than those available on Tetrapad itself.
- **Slew (CLK)** : Similar to the **Slew** option, except CV control is not continuous. Rather, the incoming CV is sampled by the clock (using either the internal clock or an external clock patched into Tête's **CLK** input), and is held until the next clock. This enables you to synchronize slew rate changes to a clock.
- **Slew (Trig)** : Similar to the **Slew** option, except CV control is not continuous. Rather, the incoming CV is sampled on the leading edge of any signal patched into an input (**RESET** or **TRIG**) that's assigned to the "**Mod Trig**" function in the CV Setup Menu. It is then held until the next trigger. This enables you to synchronize slew rate changes to an external trigger source.

- **Slew (Pad)** : Similar to the **Slew** option, except CV control is not continuous. Rather, the incoming CV is sampled each time you touch a pad, and is held until the next touch. This enables you to synchronize slew rate changes to touches on Tetrapad's pads.

- **Level** : Uses the CV input to continuously scale the output level of the Combo Pad.

In this case, incoming CV acts as a multiplier. At +5 V, 100% of the pad's current voltage is sent to the output. At 2.5V, 50% of the pad's current voltage is sent to the output. At 0V, 0% of the stored voltage is sent to the output. Negative voltages scale and invert the voltages.

NOTE: If the input CV is 0V, then you will get no output from your Tetrapad (since 0V means you transmit 0% of your stored value). So if you select this option, you'll definitely need to patch a CV source into the input.

- **Level (CLK)** : Similar to the **Level** option, except CV control is not continuous. Rather, the incoming CV is sampled by the clock (using either the internal clock or an external clock patched into Tête's **CLK** input), and is held until the next clock. This enables you to synchronize level changes to a clock.
- **Level (Trig)** : Similar to the **Level** option, except CV control is not continuous. Rather, the incoming CV is sampled on the leading edge of any signal patched into an input (**RESET** or **TRIG**) that's assigned to the "**Mod Trig**" function in the CV Setup Menu. It is then held until the next trigger. This enables you to synchronize level changes to an external trigger source.
- **Level (Pad)** : Similar to the **Level** option, except CV control is not continuous. Rather, the incoming CV is sampled each time you touch a pad, and is held until the next touch. This enables you to synchronize level changes to touches on Tetrapad's pads.
- **Offset** : Continuously adds the value at the CV input to the current pad-generated value.

For example, assume a pad, without offset, sends 2V to Out 1. If you send 1V into the CV input, then 3V (2V + 1V) would appear at Out 1.

Similarly, assume a pad, without offset, sends -3V to Out 1. If you send 1V into the CV input, then -2V (-3V + 1V) would appear at Out 1.

NOTE: Tetrapad's output voltages are capped at $\pm 5V$, so you if your stored voltage + the input CV voltage adds up to more than 5V, only 5V will be sent to the Tetrapad output.

- **Offset (CLK)** : Similar to the **Offset** option, except CV control is not continuous. Rather, the incoming CV is sampled by the clock (using either the internal clock or an external clock patched into Tête's **CLK** input), and is held until the next clock. This enables you to synchronize offsets to a clock.
- **Offset (Trig)** : Similar to the **Offset** option, except CV control is not continuous. Rather, the incoming CV is sampled on the leading edge of any signal patched into an input (**RESET** or **TRIG**) that's assigned to the "**Mod Trig**" function in the CV Setup Menu. It is then held until the next trigger. This enables you to synchronize offsets to an external trigger source.

-
- **Offset (Pad)** : Similar to the **Offset** option, except CV control is not continuous. Rather, the incoming CV is sampled each time you touch a pad, and is held until the next touch. This enables you to synchronize offsets to touches on Tetrapad's pads.
 - **Scale Root** : If you're using Quantized Combo Mode pads, then the CV input changes the root of the scale you selected in the [Combo Mode SETUP Menu](#).
 - **Scale Root (CLK)** : Similar to the **Scale Root** option, except CV control is not continuous. Rather, the incoming CV is sampled by the clock (using either the internal clock or an external clock patched into Tête's **CLK** input), and is held until the next clock. This enables you to synchronize scale root changes to a clock.
 - **Scale Root (Trig)** : Similar to the **Scale Root** option, except CV control is not continuous. Rather, the incoming CV is sampled on the leading edge of any signal patched into an input (**RESET** or **TRIG**) that's assigned to the "**Mod Trig**" function in the CV Setup Menu. It is then held until the next trigger. This enables you to synchronize scale root changes to an external trigger source.
 - **Scale Root (Pad)** : Similar to the **Scale Root** option, except CV control is not continuous. Rather, the incoming CV is sampled each time you touch a pad, and is held until the next touch. This enables you to synchronize scale root changes to touches on Tetrapad's pads.
 - **LFO Rate** : CV input continuously controls the LFO rate. Positive voltages increase the rate from its current amount. Negative voltages decrease it. Note that you cannot set LFO rates faster than Tetrapad's maximum 100 Hz rate.
 - **LFO Shape** : Uses the voltage at the CV input to cycle through the various LFO waveshape options (Sine > Triangle > Saw > Ramp > Square > Random).

0V results in no change to the LFO waveshape. That is, Tetrapad outputs the waveshape set with Tetrapad's pad encoder, as described in [LFO Basics](#). Positive input voltages cycle the waveshape upward through the options, beginning with the waveshape selected on Tetrapad, and wrapping around to the beginning when reaching the end of the waveshape list. Negative input voltages cycle the waveshape downward through the options, wrapping around to the end when reaching the beginning of the waveshape list. At $\pm 5V$, the waveshape has completely cycled through all the options, and the waveshape is once again the same as selected on Tetrapad.

- **Euclid Pulses** : Uses the voltage at the CV input to vary the number of pulses (gates) in a euclidean pattern (as discussed in [Combo Mode: Euclidean](#)).

The changes occur in real time, altering the euclidean rhythm and creating movement in your rhythms.

At +5V, the number of pulses added equals the number of steps in the pattern. At -5V, the number of pulses subtracted also equals the number of steps in the pattern. In either cases, you cannot extend the number of pulses above the existing pattern length or below 0.

For example, assume you created a 4|16 pattern on Tetrapad (4 pulses in a 16-step length). Since only 12 pulses are needed to reach the maximum value of 16 ($\frac{3}{4}$ of the 16 pulses added by +5V), only 3.75 V are needed to maximize the number of pulses.

- **Euclid Steps** : Uses the voltage at the CV input to vary the length (number of steps) in a euclidean pattern (as discussed in [Combo Mode: Euclidean](#)).

The changes occur in real time, altering the euclidean rhythm and creating movement in your rhythms.

At -5V, 64 steps are subtracted from the pattern length currently assigned on Tetrapad's panel (bottoming out when the length decreases to a single step). At +5V, 64 steps are added to the pattern length currently assigned on Tetrapad's panel (max'ing out when the total length hits 64 steps).

For example, assume you initially created a 16 step pattern on Tetrapad. Since only 48 more steps are needed to reach the maximum value of 64 ($\frac{3}{4}$ of the 64 steps added by supplying +5V), only 3.75V are needed to maximize the number of steps (length).

- **Euclid Rotation** : Uses the voltage at the CV input to rotate the current patterns forward or backward in time.

The changes occur in real time, creating movement in your rhythms.

At +5V the pattern shifts later in time by the current length of the Euclidean sequence. At -5V, the pattern shifts earlier in time by the current length of the Euclidean sequence.

For example, assume you initially created a 1|4 pattern on Tetrapad (1 pulse in a 4-step length), and that the single pulse plays on the "1." At 1.25V ($\frac{1}{4}$ of 4 step length), the pulse rotates to the "2." At 2.5V, it rotates to the "3," and at 3.75V is rotates to the "4." At 5V, it rotates back to its original location on the "1."

Reset CV

The final item in the CV Setup menu, “Reset CV,” lets you return Tête’s CV setups to their factory default assignments. To do so:

1. With the CV Setup menu visible, rotate Tête’s Screen Encoder to select the “Reset CV” entry.
2. Press the Screen Encoder.
A “dialog box” appears, asking you to confirm whether or not you want to reset Tête to its default CV setup.
3. Rotate the Screen Encoder to select “Yes,” then press the Encoder to execute the load.
4. Tête’s factory CV setups are now assigned to its input and output jacks.

The following table lists the default CV setups for each mode:

JACK	COMBO MODE	NOTES MODE	VOLTAGES MODE
Sync*	Clock	Clock	Clock
A	Loop Position	Loop Position	Loop Position
B	EOL/EOS	EOL/EOS	EOL/EOS
Trig*	Mod Trig	Mod Trig	Mod Trig
Reset*	Reset	Reset	Reset
X	All : -	Octave	Bank X CV
Y	All : -	Inversion	Bank Y CV
Z	All : Slew	Slew	Slew

FILE Menu

Use the FILE menu to load, save, rename and delete Tête presets, and to set whether or not a preset uses Tête’s global CV setup, or memorizes its own CV setups.

Tête can store as many as 297 presets — up to 99 for each of its three modes (Combo, Notes, and Voltages). Each preset contains the following data:

- All the settings assigned in the [Mode SETUP Menu](#).
- All the CV settings for all the assignable input and outputs, as set in the [CV SETUP Menu](#).

NOTE: When loading presets, you can choose whether or not you want the patch’s CV Assignments to load as part of the patch (“Load w/CV”), or be ignored (“Load”). Ignoring a preset’s CV assignments allows you to preserve Tête’s current CV assignments when loading presets.

- A recorded [Loop](#) or [Sequence](#).
- Tempo of internal clock (but not the “External” vs “Internal” clock setting).

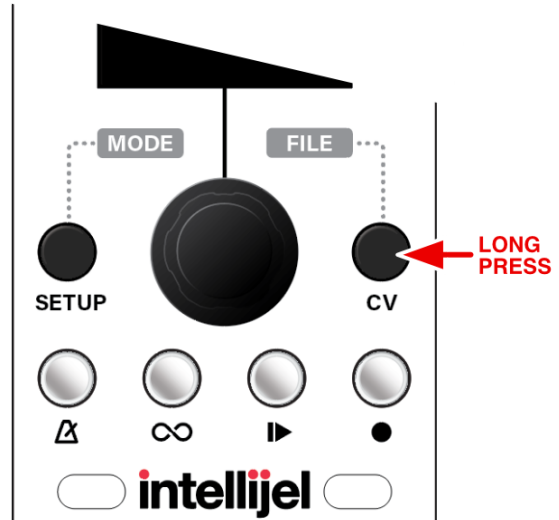

To access the FILE Menu:

1. Long-press (>1 sec) the **CV FILE** button.

The screen displays the FILE menu.

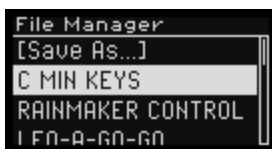

To save the current Tête/Tetrapad state as a preset:

1. Rotate Tête's Screen Encoder to highlight the [**Save As...**] option.
2. Press the Screen Encoder.

You'll next see a screen for naming the preset.



3. Rotate the Screen Encoder to select the first letter, then press it to move the cursor to the right.
The second character is ready for entry.
4. Continue rotating/pressing the Screen Encoder until you've entered the last character in the name.
5. Press the Screen Encoder to move to the next character, then (without entering a character), press it a second time.

The arrow now points down to the **OK** option.



6. Press the Screen Encoder and the named preset is saved in Tête.

To load, rename, or delete a preset:

1. Turn Tête's Screen Encoder to highlight the name of the preset you wish to load or modify.
2. Press the Screen Encoder.

A submenu appears with various options.

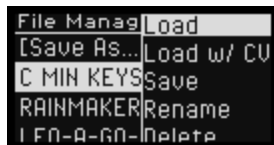

3. Turn the Screen Encoder to select one of the submenu options. Specifically:

Load: Select this option, then press the Screen Encoder to load the highlighted preset. Presets loaded with this option ignore the CV setup saved with the preset and, instead, use the current global CV setup.

Load w/CV: Select this option, then press the Screen Encoder to load the highlighted preset and its associated CV setup. Presets loaded with this option ignore the global CV setup, and use the CV setup saved with the preset.

Save: Select this option, then press the Screen Encoder to resave the highlighted preset.

Rename: Select this option, then press the Screen Encoder to rename the highlighted preset (bringing up the Preset Name menu, discussed above).

Delete: Select this option, then press the Screen Encoder to delete the highlighted preset. This action brings up a confirmation screen, in which you rotate the Screen Encoder to select between “Yes” and “No,” then press the Screen Encoder to confirm.

TEMPO Menu

Tête/Tetrapad features comprehensive clocking for recording and playing back gestural performances in either Looper (real-time) mode or Sequencer (step-recording) mode. The clock may also be used for other features, such as beat-synchronized LFOs and Euclidean Rhythms, both of which are accessible within Combo Mode. Tête's tempo can be driven externally via a clock plugged into its **CLK** input; or internally generated by either tapping the **TEMPO (Δ)** button, or by entering the desired tempo manually.

To set Tête's global tempo:

1. Long-press (>1 sec) Tête's **TEMPO (Δ)** button.
The screen displays the tempo source (Internal Clock vs. External Clock) and the current tempo.
2. Press Tête's Screen Encoder to toggle between *Internal Clock* and *External Clock*.

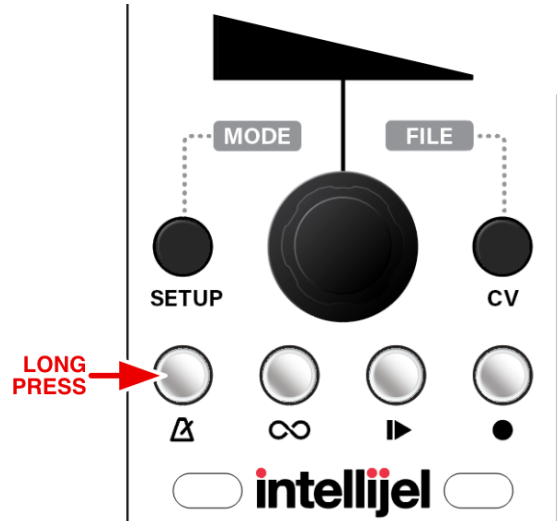

If set to *External Clock*, Tête will synchronize to the clock signal arriving at its **CLK** input jack. (Note: maximum external clock rate is 2400bpm. Anything in excess of this is ignored).



If set to *Internal Clock*, rotate Tête's Screen Encoder to set the desired tempo. To fine tune the Tempo setting (tenths of a BPM), rotate the Screen Encoder while pressing it.



You can also set the tempo by tapping on the **TEMPO (Δ)** button. When you do so, the screen will say "*Tap Tempo*," and Tête will measure the tempo at which you tap, displaying the tempo in the screen. You can tap any tempo from 20 - 480 bpm.

In all instances, the TEMPO button flashes in sync with the tempo.

3. Long-press (>1 sec) Tête's **TEMPO (Δ)** button to exit the TEMPO Menu.

PART SEVEN:
LOOPING & SEQUENCING

THE LOOPER

Tête supports two entirely different recording paradigms: *step-recording* and *real-time recording*.

Tête's real-time recorder is called *the looper*, which (like an audio looper pedal) records an input signal and plays it back in a loop. Only, instead of recording audio, Tête's looper records and loops gestures you make on Tetrapad.

This section discusses Tête's Looper (real-time recording) capabilities. See [THE SEQUENCER](#) to learn about Tête's step-sequencing capabilities.

To use the Looper, you must assign it to control Tête's recording function:

1. Press Tête's **SETUP MODE** button to display the Mode SETUP Menu button.
2. Rotate Tête's encoder to select the **Record: < x >** option (where "< x >" says either "Sequencer" or "Looper") and set it to **Looper** (pressing the encoder cycles between these two recording methods).

NOTE: This option is not available in Combo Mode, since Combo Mode ONLY works with the Looper.

3. Press Tête's **SETUP MODE** button again to exit the Mode SETUP Menu.

The Looper offers several different recording & playback methods, depending on how you prefer to work:

- **Touch Sync:** When recording with Touch Sync, you first record-enable Tête by pressing the **RECORD (●)** button. Tête then waits for you to touch a pad before it actually starts recording. Recording will stop the instant you press the **RECORD (●)** button a second time. For more information see [Record & Play with Touch Sync](#).
- **Looper Sync:** When recording with Looper Sync, you first record-enable Tête by pressing the **RECORD (●)** button. Tête then waits for the next clock signal before it starts recording. It will stop recording on the first clock after you next press the **RECORD (●)** button, insuring your loops are metrically accurate. You can even pre-set a desired number of looping beats, freeing you to concentrate on your performance. For more information see [Record & Play with Looper Sync](#).
- **Unsynced:** For those with mad skills (or are just plain mad), Tête can be configured to start recording the instant you press the **RECORD (●)** button, and to stop recording the instant you press it again. For more information see [Record & Play Unsynced](#).

These methods perform similarly with regards to playing back your recorded loop.

Also supported are several different methods for overdubbing your loops, plus the ability to save, load, rename, and delete them.

Combo Mode Looping

The Looper works with all three operating modes: Notes Mode, Voltages Mode and Combo Mode. In Notes and Voltages modes, the Looper records all pad touches since, in these modes, all pads work together in support of the mode. However, in Combo Mode, each pad can have an entirely different function, and for this reason, you can enable or disable the Looper for each of the four pads independently. To do so:

1. In Combo Mode, press the white EDIT button on Tetrapad.

This puts Tetrapad/Tête into Pad Assignment Mode, which enables you to assign any of the various pad functions to each of the four pads.

Once in Pad Assignment Mode, Tête's main screen inverts (white background) to indicate that you are in Pad Assignment Mode.

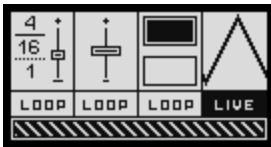

Below each of the Pad Assignment regions, in the Encoder Bar section, is the per-pad Loop Assignment display.

2. Press the corresponding Tetrapad encoder to toggle the pad between LOOP and LIVE.
 - **LOOP:** Pads assigned to LOOP are controlled by Tête's Looper. When in LOOP, you can record all the pad gestures to the Looper, and all previously recorded gestures play back.
 - **LIVE:** Pads assigned to LIVE are excluded from Tête's Looper. This means that any Pad set to LIVE will not be recorded as part of your loop. In addition, if a pad already contains recorded data, changing its setting to LIVE prevents that pad's loop from playing.
3. Press the white EDIT button on Tetrapad to exit Pad Assignment Mode.

Record & Play with Touch Sync

1. Press the **SETUP MODE** button to display the Mode SETUP Menu
2. Rotate Tête's encoder to select the **Record Wait** option, and set it to **Touch** (pressing the encoder cycles between "Off" and "Touch").

This tells Tête to wait for a touch before recording begins.

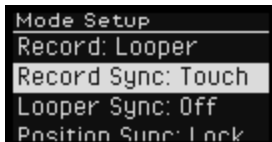

3. Rotate Tête's encoder to select the **Looper Sync** option, and set it to **Off** (pressing the encoder cycles it on and off).

This allows you to record loops for as long as desired without metric constraint.

4. Press the **SETUP MODE** button to exit the Mode SETUP Menu.
5. Rotate Tête's encoder to select **Touch Pad** (or **Touch Bank/Gate** if in Voltages Mode).

If you select a "bypass" option (rather than a "touch" option), then touching a pad plays/records a 'rest', as described further in [The Encoder Bar \(In Looper\)](#).

6. Press the **RECORD (●)** button.

It will start to flash, indicating that Tête is now record-enabled and is waiting for you to touch a pad.



7. Touch a pad to start recording.

Tête's **RECORD (●)** button lights solid red (no flashing) to indicate that recording is in progress.



8. Record your pad touches and gestures for as long as you like.

9. Press the **RECORD (●)** button to stop recording.

The **RECORD (●)** button turns off and the **PLAY (►)** button flashes green, indicating that there is now a recording in memory, but it will not start to play back until you press the **PLAY (►)** button



10. Press the **PLAY (►)** button to play back your recording.

It will light solid green (no flashing) to indicate that your recording is now playing back.



11. To pause playback, press the **PLAY (►)** button again.



The **PLAY (►)** button will flash to indicate that a sequence is loaded, but that it is not currently playing.

A paused loop stops playing, but will restart from the stopped position if the **PLAY (►)** button is pressed again.

To stop a loop, and return to its beginning, long-press the **PLAY (►)** button. A subsequent press of the **PLAY (►)** restarts the loop from the beginning.

Record & Play with Looper Sync

1. Press the **SETUP MODE** button to display the Mode SETUP Menu.
2. Rotate Tête's encoder to select the **Looper Sync** option, and set it to **On** (pressing the encoder cycles it on and off).

This synchronizes Tête's recording length to the clock (internal or external), meaning recording commences 'on the beat,' and it stops 'on the beat.'

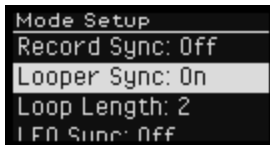

3. Rotate Tête's encoder to select the **Loop Length** option, and set it to the desired loop length (expressed in 'number of beats'.)

If you select a number, then Tête will automatically record for that number of beats. If you select "-", Tête will begin recording on the beat, but will record for as long as you like, stopping on the first beat after you stop recording.

4. Press the **SETUP MODE** button to exit the Mode SETUP Menu.
5. Rotate Tête's encoder to select **Touch Pad** (or **Touch Bank/Gate** if in Voltages Mode).

If you select a "bypass" option (rather than a "touch" option), then touching a pad plays/records a 'rest', as described further in [The Encoder Bar \(In Looper\)](#).

6. Press the **RECORD (●)** button.

It will start to flash, indicating that Tête is record-enabled and is waiting for the next clock pulse to begin recording.^(note 1)

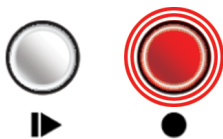

Tête plays at whatever tempo you define in the [TEMPO menu](#) (accessed by pressing the **TEMPO (♩)** button and can either be clocked internally or externally (via its **SYNC** input).

*NOTE 1: Instead of waiting for the next clock to commence recording, you can tell Tête to wait for the next **TRIG** input instead. Do this by assigning Tête's TRIG input to "Looper" in the [CV Setup Menu](#). Now the loop won't start recording until there's a pulse at the TRIG input. In addition, when using the TRIG input, Looper Sync is decoupled from the Clock, and is instead set by the time between TRIG inputs.*

7. Tête's **RECORD (●)** button automatically lights solid red (no flashing) when recording begins.



8. Record your pad touches and gestures.
9. Press the **RECORD (●)** button to stop recording.

*NOTE: If you assigned a **Loop Length** in the Mode **SETUP** Menu, then you will not need to press the **RECORD (●)** button to stop recording — recording will stop automatically after the chosen number of beats.*

The **RECORD (●)** button will flash, indicating that Tête is waiting until the next clock pulse to actually stop recording (thus conforming the length of your loop to the beat).



Once a clock pulse is received, the **RECORD (●)** button turns off and the **PLAY (►)** button flashes to indicate that a recording exists but is not currently playing.



10. Press the **PLAY (►)** button to play back your recording.

It will begin to *rapidly* flash green, indicating that Tête is waiting until the next clock pulse to actually start playback (thus keeping you loop rhythmically locked to the beat).

Once a clock pulse is received, the **PLAY (►)** will light solid green (no flashing) to indicate that your recording is now playing back.



11. To stop playback, press the **PLAY (►)** button again.

Playback will stop, and the **PLAY (►)** button will flash to indicate that a recording exists but is not currently playing.

Record & Play Unsynced

1. Press the **SETUP MODE** button to display the Mode SETUP Menu.
2. Rotate Tête's encoder to select the **Record Wait** option, and set it to **Off** (pressing the encoder cycles between "Off" and "Touch").

This tells Tête to begin immediately upon pressing the **RECORD (●)** button.

3. Rotate Tête's encoder to select the **Looper Sync** option and set it to **Off**, as well.

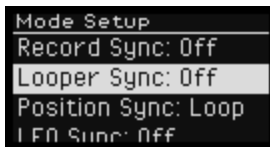

4. Press the **SETUP MODE** button to exit the Mode SETUP Menu.
5. Rotate Tête's encoder to select **Touch Pad** (or **Touch Bank/Gate** if in Voltages Mode).
If you select a "bypass" option (rather than a "touch" option), then touching a pad plays/records a 'rest', as described further in [The Encoder Bar \(In Looper\)](#).
6. Press the **RECORD (●)** button.



The **RECORD (●)** button will light solid red, and Tête will immediately begin to record any gestures, with no regard to the beat or whether you're touching a pad.

7. Record your pad touches and gestures for as long as you like.
8. Press the **RECORD (●)** button to stop recording.



The **RECORD (●)** button turns off and the **PLAY (►)** button flashes green, indicating that there is now a recording in memory, but it will not start to play back until you press the **PLAY (►)** button.

9. Press the **PLAY (►)** button to play back your recording.



It will light solid green (no flashing) to indicate that your recording is now playing back.

10. To stop playback, press the **PLAY (►)** button again. Playback will stop, and the **PLAY (►)** button will flash to indicate that a recording exists but is not currently playing.

Overdubbing

You can overdub a new loop (or section of a loop) on top of an existing recording. To do so:

1. Load a loop as described in the [FILE Menu](#) discussion (or use the one you just recorded).
2. Press the **PLAY (▶)** button.

The loop starts playing.

3. Press the **RECORD (●)** button.

Both the **RECORD (●)** and **PLAY (▶)** buttons are lit solid.

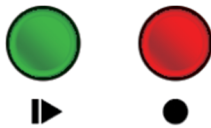

4. As the loop plays, make new gestures on Tetrapad any time you hear a section you'd like to replace or change.

Tête overwrites the old gestures with new ones, allowing you to tweak and evolve a loop in real time.

NOTE: There are several ways to alter what, precisely, you record. For example, you can make your button presses erase part of the existing sequence, rather than writing new data. Or, in the case of Voltages Mode, you can replace just the voltage bank selection without overwriting the gate pattern, or vice versa. This is discussed further in [The Encoder Bar \(In Loooper\)](#).

5. Press the **RECORD (●)** button when you're done overdubbing your loop.

If you set the **Post Record** parameter to “Overdb” in the Mode Setup Menu, then you can overdub immediately after creating your first recording by pressing the **PLAY (▶)** button (rather than the **RECORD (●)** button) to “end” a recording. This defines the loop length, but both buttons remain solidly lit, indicating that the loop is playing back, but that you're now overdubbing new gestures. This lets you record a loop and evolve it without ever needing to stop playback.

The Encoder Bar (In Looper)

The Encoder Bar provides immediate access to numerous mode-specific touch-modifications that are useful when you perform, record or play loops and sequences. This section discusses the mode-specific Encoder Bar options that are available when using the Looper.

Combo Mode Encoder Bar (Looper)

In Combo Mode, turning Tête’s encoder selects between two touch options:



Touch / Record Pad

This is the ‘normal’ mode of operation. Touching a pad causes the pad to respond normally (as programmed in Combo Mode). When recording, the option becomes **Record Pad**, and the function of the pad is recorded into the loop.



Bypass / Erase Pad

In this mode, touching a pad silences playback for as long as a pad is touched. When you play back a recording, **Bypass Pad** lets you touch a pad to temporarily silence playback while the loop continues to play in sync.

When recording, the option becomes **Erase Pad**, which lets you record a ‘rest’ for as long as a pad is touched. When overdubbing, **Erase Pad** is useful for spot-erasing previous sections of your recording.

Notes Mode Encoder Bar (Looper)

In Notes Mode, turning Tête’s encoder selects between two touch options:



Touch / Record Pad

This is the ‘normal’ mode of operation. Touching a pad causes the pad to respond normally (playing whatever notes you’ve assigned in Notes Mode). When recording, the option becomes **Record Pad**, and the notes are recorded into the loop.



Bypass / Record Pad

In this mode, touching a pad silences playback for as long as a pad is touched. When you play back a loop, **Bypass Pad** lets you touch a pad to temporarily silence playback while the loop continues to play in sync.

When recording, the option becomes **Erase Pad**, which lets you record a ‘rest’ for as long as a pad is touched. When overdubbing, **Erase Pad** is useful for spot-erasing previously recorded notes.

Voltages Mode Encoder Bar (Looper)

In Voltages Mode, turning Tête’s encoder selects between four touch options:



Touch / Record Bank/Gate

This is the ‘normal’ mode of operation. Touching a pad sends the programmed bank of voltage values to the outputs, along with a gate signal to one of Tête’s assignable CV outputs (If you assigned it to output “touch”).

When recording, the option becomes **Record Bank/Gate**, and your voltage changes and touch gates are recorded into the loop.



Touch / Record Bank Only

In this mode, touching a pad sends the programmed bank of voltage values to the outputs, but it does not send a gate signal to Tête’s assignable CV output. This is useful when you’re playing back a loop, since it lets you change voltage values without altering the previously recorded gate pattern.

When recording, the option becomes **Record Bank Only**, and your voltage bank changes are recorded into the loop, but not gate signals. This can be particularly helpful when you want to overdub new voltage changes without altering the recorded gate loop.



Touch / Record Gate Only

In this mode, touching a pad sends a gate signal to Tête’s assignable CV output (provided you’ve assigned the “Touch” function to the CV output), but it does not send voltage bank changes. This is useful when you’re playing back a loop, since it lets you change rhythmic gate patterns without altering the previously recorded voltage changes.

When recording, the option becomes **Record Gate Only**, and your gate gestures are recorded into the loop, but not the voltage bank changes. This can be particularly helpful when you want to overdub new rhythmic patterns over an existing voltage loop.



Bypass Bank/Gate | Erase Gate

In this mode, touching a pad silences playback for as long as a pad is touched. When you play back a loop, **Bypass Bank/Gate** lets you touch a pad to temporarily silence playback while the loop continues to play in sync.

When recording, the option becomes **Erase Gate**, which lets you record a ‘rest’ for as long as a pad is touched. When overdubbing, **Erase Gate** is useful for spot-erasing previously recorded voltage gates.

Save, Load, Rename and Delete Loops

You can save your loops to Tête's micro SD card, load an existing one, rename loops, and delete them. All these functions are handled through the [FILE Menu](#), which was described earlier, and is accessed by long-pressing (>1 sec) the **CV FILE** button.

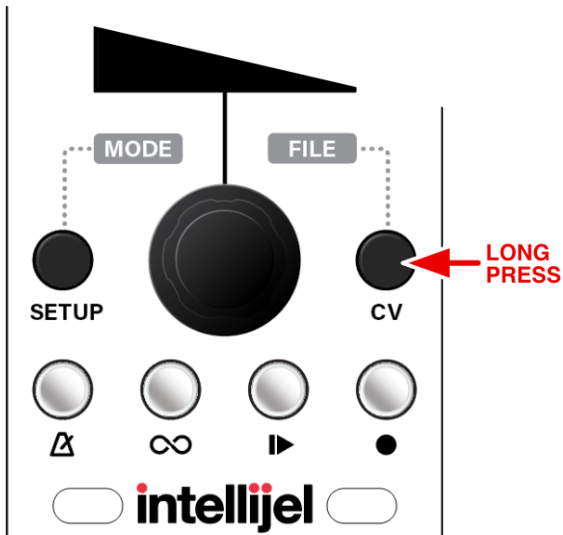

THE SEQUENCER

Tête supports two entirely different recording paradigms: *step-recording* and *real-time recording*. Tête's real-time recorder is called *the looper*, while its step-recorder is referred to simply as *the sequencer*.

This section discusses Tête's Sequencer (step-recording) capabilities. See [THE LOOPER](#) to learn about Tête's real-time recording function.

Sequencing is supported only in Notes Mode and Voltages Mode. Combo mode (due to its more fluid and dynamic nature) works only with the Looper.

To use the Sequencer, you must assign it to control Tête's recording function:

1. Press Tête's **SETUP MODE** button to display the Mode SETUP Menu button.
2. Rotate Tête's encoder to select the **Record: < x >** option (where "< x >" says either "Sequencer" or "Looper") and set it to **Sequencer** (pressing the encoder cycles between these two recording methods).

NOTE: This option is not available in Combo Mode, since Combo Mode works ONLY with the Looper, and not the Sequencer.

3. Press Tête's **SETUP MODE** button again to exit the Mode SETUP Menu.

Record & Play A Note Sequence

1. Long-press (>1 second) the **SETUP MODE** button to display the MODE Select Menu; turn the encoder to highlight **Notes** and press the encoder.

Tête and Tetrapad are now in Notes Mode.

2. Assign Tête's Record function to **Sequencer**, as discussed above.
3. In the Mode SETUP Menu (accessed by short-pressing the **SETUP MODE** button), set the desired number of virtual "keys," and a note assignment method (w/Scale, w/Chords, or Manually), then assign those notes as discussed in the [NOTES MODE](#) section.
4. If you're not already at the top-level Notes Mode screen, press the **SETUP MODE** button.

When using the Sequencer in Notes mode, the bottom half of the screen will contain a miniature piano roll display, along with some additional information.

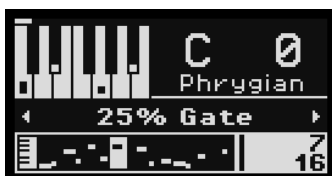

Recording a Note Sequence

To record a sequence:

1. Press Tête's **RECORD (●)** button.
2. Step-enter notes by pressing the desired "key" on your Tetrapad.
Each time you press a "key" on Tetrapad, its note value is displayed on the scrolling piano roll and the sequencer advances one step.
3. To set the gate time for a note, rotate Tête's encoder to select either a **25%**, **50%**, or **75% Gate** time prior to touching a "key."
The length of the note displayed on the piano roll indicates the length of the gate.
4. To enter a rest rather than a note, rotate Tête's encoder to select **Rest**, then press any "key" on Tetrapad.
A rest will be entered (no note), and the sequence will advance one step.
5. To tie or slur a note into the one that will follow it, rotate Tête's encoder to show **Tie/Slur**, then press the desired note "key" on Tetrapad.
The note you just entered will either tie into the next note you enter (if you next press the same note), or slur into it (if you next press a different note).
6. Continue entering notes, rests and ties/slurs, up to a maximum of 256 steps.
7. When you're done recording, press the **RECORD (●)** button again.

Playing Back a Note Sequence

To play back a sequence:

1. Press Tête's **PLAY** (▶) button.

The sequence plays back at the tempo defined in the [TEMPO Menu](#) (accessed by pressing Tête's **TEMPO** (⌘) button). It will use either the internal clock or an external clock (if one is patched into Tête's **CLK** input and **External Clock** is enabled).

2. To speed up or slow down playback, set the **Seq Clock** parameter in the Mode SETUP Menu (accessed by pressing Tête's **SETUP MODE** button).

You can divide the clock by *1/2*, *1/3* or *1/4* or multiply it by **x1**, **x2**, **x3**, or **x4**.

3. To play back with swing, set the **Seq Swing** parameter in the Mode SETUP Menu.

Options include **50**, **54**, **58**, **62**, **66**, **70**, and **75%** swing.

4. As the sequence plays, take note of several features of Tête's display, as shown below:

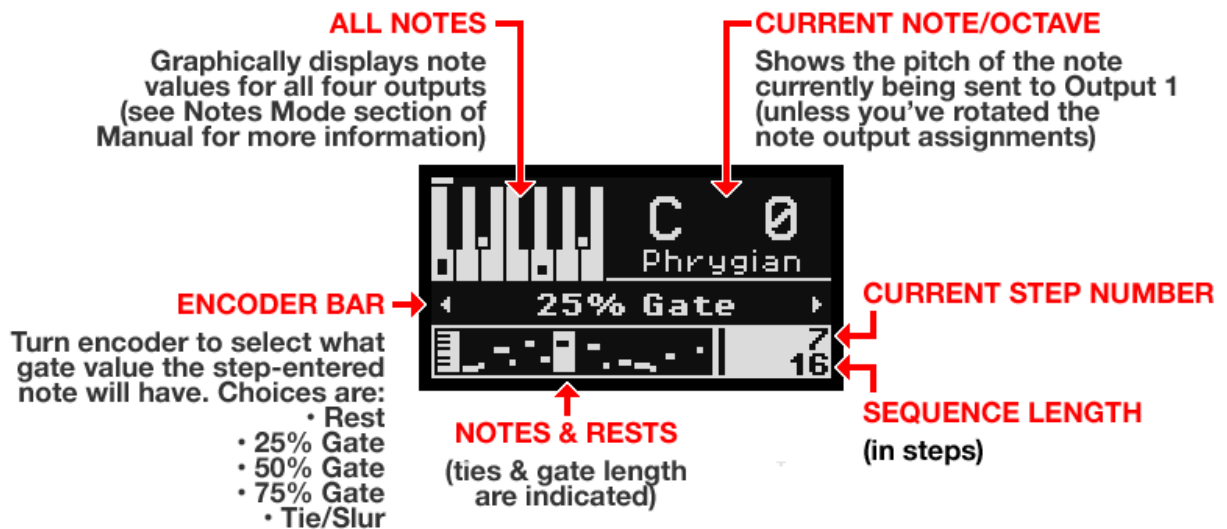

5. To pause a sequence, press the **PLAY** (▶) button again.



The **PLAY** (▶) button will flash to indicate that a sequence is loaded, but that it is not currently playing.

A paused sequence stops playing, but will restart from the stopped position if the **PLAY** (▶) button is pressed again.

6. To stop a sequence, and return to its beginning, long-press the **PLAY** (▶) button. A subsequent press of the **PLAY** (▶) restarts the sequence from the beginning.

Record & Play A Voltage Sequence

1. Long-press (>1 second) the **SETUP MODE** button to display the MODE Select Menu; turn the encoder to highlight **Voltages** and press the encoder.

Tête and Tetrapad are now in Voltages Mode.

2. Assign Tête's Record function to "Sequencer," as discussed at the beginning of ["THE SEQUENCER"](#) section.
3. In the Mode SETUP Menu (accessed by short-pressing the **SETUP MODE** button), set the desired number of voltage bank pads (8, 12, or 16) accessible from Tetrapad.
4. If you want your Tetrapad touches to trigger gate events in addition to voltage changes, use the CV Setup menu to assign either **CV A** or **CV B** to output "Touch."

This will enable Tête to send a gate signal every time you touch a pad (using the CV output you assigned).

NOTE: If you don't want voltage changes to trigger gate events, you could either disable the CV setup option, or simply not patch into the assigned CV output jack.

5. If you're not already at the top-level Notes Mode screen, press the **SETUP MODE** button.

When using the Sequencer in Voltages Mode, the bottom half of the screen will contain a miniature 'voltage roll' display, along with some additional information. Each pad is represented in the 'voltage roll' according to a zig-zag pattern. So the pad on the lower-left is the lower pad indicated on the Tête screen, while the pad at the upper-right is the highest.

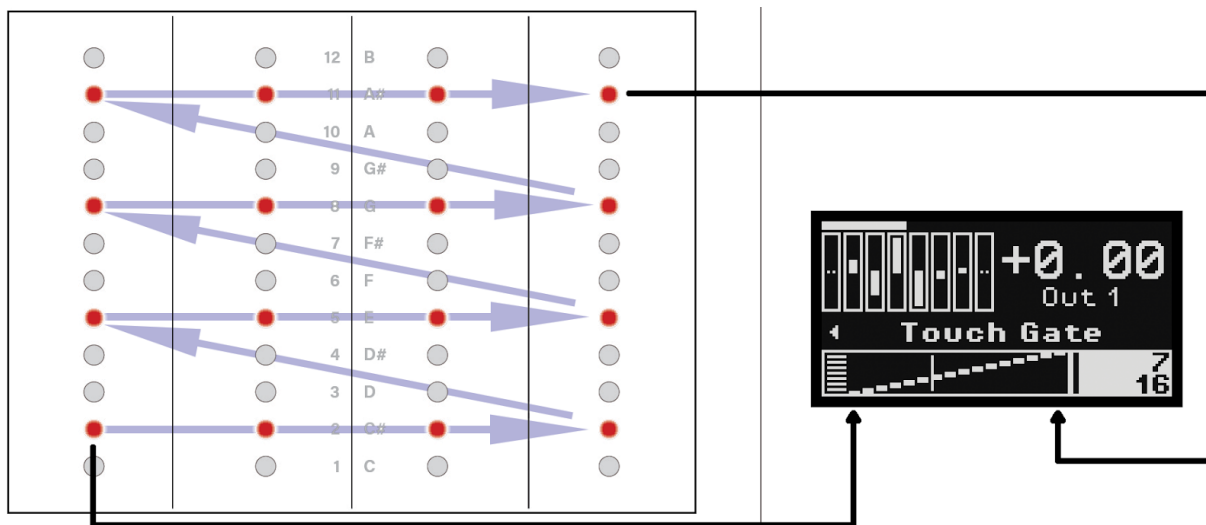

Recording a Voltage Sequence

To record a voltage sequence:

1. Press Tête's **RECORD (●)** button.

2. Step-enter voltages by pressing the desired pad on your Tetrapad.

Each time you press a pad on Tetrapad, the top half of Tête's screen shows a graphical indication of all 8 voltages stored in that pad's bank, plus the numerical value of the voltage being sent to Out 1.

In addition, the pad is added to the scrolling voltage roll, and the display advances one step.

3. You can enter each pad press with or without gates. To enter a pad press with a gate event, rotate the Encoder so that Tête's Encoder Bar says "Record Gate." To enter a pad press without a gate event, rotate the Encoder so that Tête's Encoder Bars say "Bypass Gate."
4. These gate pattern choices have an audible effect only if you've assigned either **CV A** or **CV B** to output a **Touch** event in the CV Setup menu.
5. If you want multiple sequential steps to contain the same voltage bank, simply press the same pad multiple times.
6. Continue entering voltage banks events, up to a maximum of 256 steps.
7. When you're done recording, press the **RECORD (●)** button again.

Playing Back a Voltage Sequence

To play back a voltage sequence:

1. Press Tête's **PLAY (▶)** button.

The sequence plays back at the tempo defined in the [TEMPO Menu](#) (accessed by pressing Tête's **TEMPO (⏸)** button). It will use either the internal clock or an external clock (if one is patched into Tête's **CLK** input and **External Clock** is enabled).

2. To speed up or slow down playback, set the **Seq Clock** parameter in the Mode SETUP Menu (accessed by pressing Tête's **SETUP MODE** button).

You can divide the clock by */2*, */3* or */4* or multiply it by **x1**, **x2**, **x3**, or **x4**.

3. To play back with swing, set the **Seq Swing** parameter in the Mode SETUP Menu.

Options include **50**, **54**, **58**, **62**, **66**, **70**, and **75%** swing.

4. As the sequence plays, take note of several features of Tête's display, as shown below:

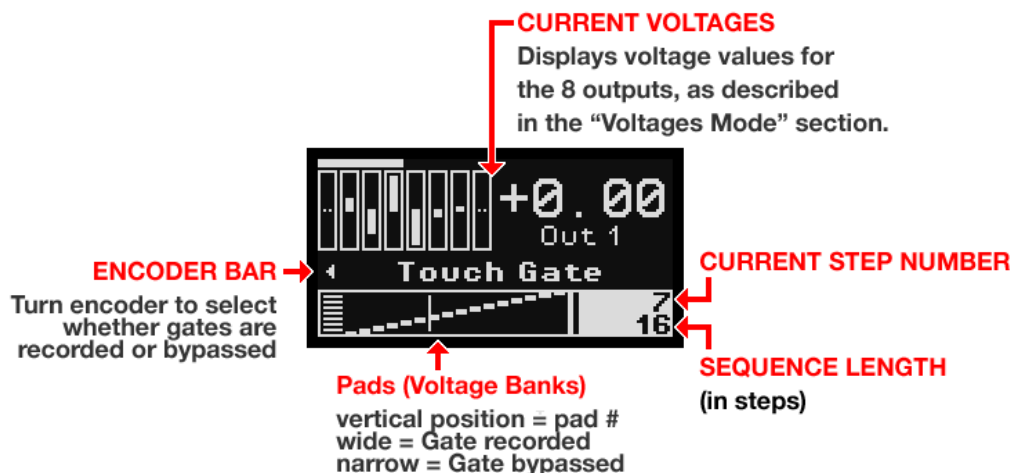

7. To pause a sequence, press the **PLAY (▶)** button again.



The **PLAY (▶)** button will flash to indicate that a sequence is loaded, but that it is not currently playing.

A paused sequence stops playing, but will restart from the stopped position if the **PLAY (▶)** button is pressed again.

8. To stop a sequence, and return to its beginning, long-press the **PLAY (▶)** button. A subsequent press of the **PLAY (▶)** restarts the sequence from the beginning.

Editing Sequences

There are several ways to edit an existing sequence:

- **Append:** use this method to create or extend a sequence.
The default state when pressing the **RECORD (●)** button while the sequencer is stopped.
- **Overwrite:** use this method to overwrite any step or steps in an existing sequence.
- **Insert:** use this method to insert a step between two existing steps.
- **Overdub:** use this method to overdub while your sequence plays.
The state entered when pressing the **RECORD (●)** button while the sequencer is playing.

You can load any sequence as described in the [FILE Menu](#) discussion (or use the one you just recorded).

Appending Sequences

You can extend the length of an existing sequence, and append more steps to it. To do so:

1. If the sequence is currently playing back, press the **PLAY (►)** button to stop playback.
2. Press the **RECORD (●)** button.
The cursor in the piano/voltage roll moves to the end of the existing sequence.
3. Rotate Tête's Encoder to define the gate parameters of the event you wish to enter.
For voltages, this means deciding whether to add a gate action or not.
For notes, it means deciding whether to add a rest, a tie/slur, or a note with a gate value of 25%, 50%, or 75%.
4. Touch the pad corresponding to the value of the note or voltage bank you wish to add.
Tête adds the note or voltage bank to the end of your sequence and advances it one step.
5. Continue adding steps until your sequence is the desired length.

Overwriting Sequences

You can overwrite steps in an existing sequence. To do so:

1. If the sequence is currently playing back, press the **PLAY (▶)** button to stop playback.
2. Press the **RECORD (●)** button.
The cursor in the piano/voltage roll moves to the end of the existing sequence.
3. Press the **LOOPY (∞)** button.
The Encoder Bar will read **Overwrite Mode**.
4. Rotate the Encoder to move the cursor around inside the existing sequence.
NOTE: If you move the cursor to the end of the sequence, you'll exit Overwrite Mode, and be back in Append Mode.
5. When the cursor is over the step you want to overwrite, press the pad corresponding to the new value you want.
6. Additionally, you can press Tête's Encoder, then rotate to change the step's gate parameters.
For voltages, this means deciding whether to add a gate action or not.
For notes, it means deciding whether to add a rest, a tie/slur, or a note with a gate value of 25%, 50%, or 75%.
7. Press the Encoder to toggle between using it to scroll through the sequence, or using it to define gate parameters.
8. To DELETE a step, simply press-and-hold the Encoder over the step you want deleted.

Inserting Into Sequences

You can insert steps into an existing sequence. To do so:

1. If the sequence is currently playing back, press the **PLAY (▶)** button to stop playback.
2. Press the **RECORD (●)** button.
The cursor in the piano/voltage roll moves to the end of the existing sequence.
3. Press the **LOOPY (∞)** button.
The Encoder Bar will read **Overwrite Mode**.
4. Press the **LOOPY (∞)** button again.
The Encoder bar will read **Insert**, and the cursor will show where, exactly the note will be inserted.

You can toggle between **Insert** and **Overwrite Mode** by repeatedly pressing the **LOOPY** button.

5. Rotate the Encoder to move the cursor around inside the existing sequence.

NOTE: If you move the cursor to the end of the sequence, you'll exit Insert Mode, and be back in Append Mode.

6. When the cursor is over the step before which you want to insert a new event, press the pad corresponding to the value you want inserted.
7. Additionally, you can press Tête's Encoder, then rotate to change the step's gate parameters.

For voltages, this means deciding whether to add a gate action or not.

For notes, it means deciding whether to add a rest, a tie/slur, or a note with a gate value of 25%, 50%, or 75%.

8. Press the Encoder to toggle between using it to scroll through the sequence, or using it to define gate parameters.
9. To DELETE a step, simply press-and-hold the Encoder to delete the step before the position marker.

Overdubbing Sequences

You can record over an existing sequence as it plays back. To do so:

1. Load a sequence as described in the [FILE Menu](#) discussion (or use the one you just recorded).
2. Press the **PLAY (▶)** button.

The sequence starts playing.

3. Press the **RECORD (●)** button.

Both the **RECORD (●)** and **PLAY (▶)** buttons are lit solid.



4. As the sequence plays, press a new pad on Tetrapad any time you hear a section you'd like to replace or change.

Tête overwrites the old step-recorded value with the new ones, allowing you to tweak and evolve a sequence in real time.

5. Press the **RECORD (●)** button when you're done overdubbing your loop.

Save, Load, Rename and Delete Sequences

You can save your sequences to Tête's micro SD card, load an existing one, rename loops, and delete them. All these functions are handled through the [FILE Menu](#), which was described earlier, and is accessed by long-pressing (>1 sec) the **CV FILE** button.

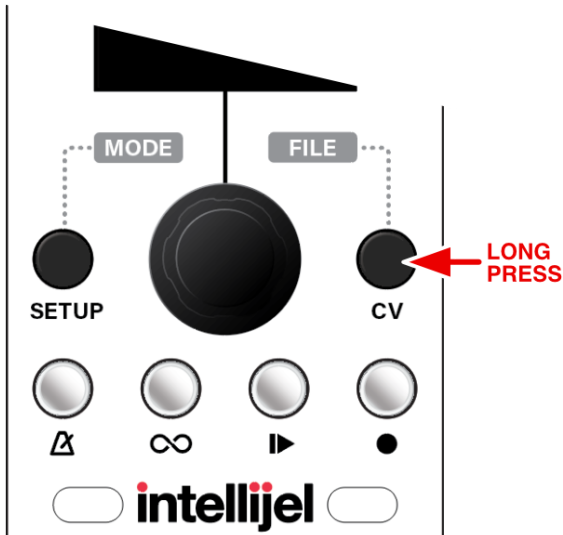

LOOPY

Loopy is a special performance feature, which lets you play back short, looping sections taken from within a longer Sequence or Loop.

In general, you engage Loopy by pressing the **LOOPY** (∞) button during playback, which causes a user-definable subsection of the recording to loop repeatedly. You can toggle Loopy on/off by repeatedly pressing the button, or you can press-and-hold the button as a recording plays — using the button to gate the duration of the Loopy effect.

Loopy with Sequences

When using the Loopy feature with Sequences, Tête's encoder bar sets the number of steps in a loopy, as shown below:

1. Press the **PLAY** (▶) button to start Sequence



2. As Sequence plays, press the **LOOPY** (∞) button.



3. Beginning with the step at which you press the **LOOPY** (∞) button, a subset of the sequence starts to loop.

The segment length is shown in Tête's Encoder Bar, and is set by turning Tête's Encoder. In this example, Loopy was set to "Loop 3 Steps".

4. Press the **LOOPY** (∞) button again to turn it off. Tête returns to playing back the entire sequence.

NOTE: Alternately, rather than toggling Loopy on/off by repeatedly pressing the **LOOPY** (∞) button, you can press-and-hold it to temporarily engage the Loopy function for as long as you hold down the button. With the **LOOPY** (∞) button held down, you can still turn Tête's Encoder to change Loopy's length).

Loopy Length with Sequences

Loopy lengths can be as short as a single step or as long as your entire sequence. To change Loopy's length:

1. Press the **LOOPY (∞)** button (lighting it).

Tête's Encoder Bar highlights, showing the current Loopy length setting.



2. Turn the encoder to increase or decrease Loopy's playback length, in single step increments.

You can also adjust the Loopy length in real-time as a Loopy Sequence plays back.

Additionally, you can control Loopy Length using CV, as discussed in [CV Setup Menu](#).

Loopy Shift with Sequences

During sequence playback, Loopy starts playing its sub-loop at whichever point you press the **LOOPY (∞)** button. However, as Loopy plays, you can shift the step at which Loopy begins playback either forward or backward through the Sequence. To do so:

1. With the Sequence playing back, press the **LOOPY (∞)** button (lighting it).

Loopy begins looping a subset of the sequence, beginning on the step at which you pressed the **LOOPY (∞)** button, using a Loopy length as shown on Tête's Encoder Bar.

As Loopy plays, press the Tête's encoder to toggle encoder control to the Loopy Shift feature.

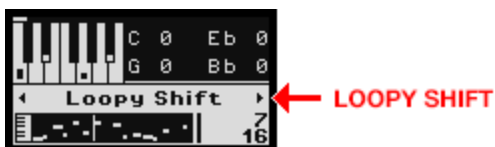

2. Turn the encoder clockwise to shift Loopy's starting step *later* in time. Turn the encoder counterclockwise to shift Loopy's starting step *earlier* in time.
3. Press the encoder to toggle back and forth between **Loopy Length** and **Loopy Shift** control — varying each in real-time as your Loopy segment plays.

NOTE: If the **LOOPY (∞)** button is currently on, you can toggle the Encoder Bar back to the standard Gate function by long-pressing (>1 sec) the Encoder. This enables you to adjust gate times as well as Loopy parameters while a Loopy segment continues to play.

Position Sync with Sequences

After Loopy has played back a series of sub-steps, playback of the full-length sequence is resumed. The precise position at which playback resumes is determined by the **Loopy Pos. Sync** parameter, located in the Mode SETUP Menu.

Specifically:

1. Press Tête's **SETUP MODE** button, and scroll down to the **Loopy Pos. Sync** parameter. There are two options: *Off* and *On*.
2. If you want the playback to snap to the position where it would have been had you never engaged Loopy, then set **Loopy Pos. Sync** to *On*.
3. If you want the playback to continue to play from the position you were in within Loopy, set **Loopy Pos. Sync** to *Off*.

The following examples illustrate the difference between these two options:

1. Assume your Sequence is the 8-steps shown on the top line (below), and your Loopy segment is the demarcated 2-step subset length:

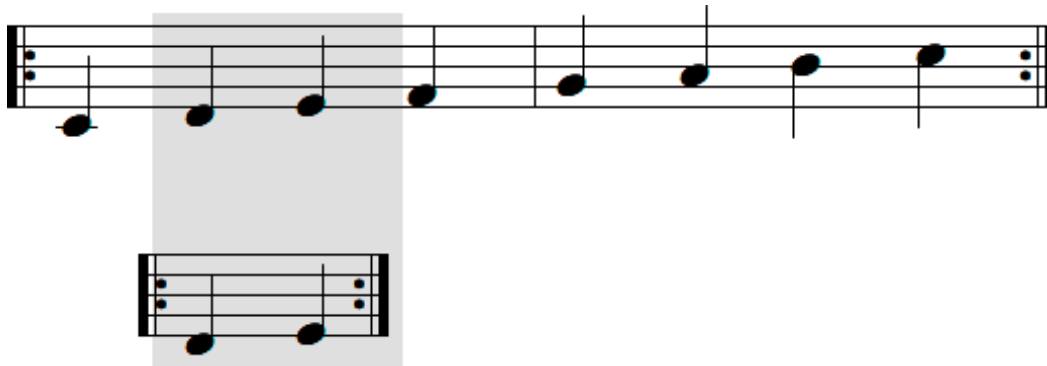

2. Assume you start playing Loopy at the position indicated by the **RED** arrow (below), and that you play the Loopy segment 3 times. If **Loopy Pos. Sync** is set to *On*, then when Loopy stops playing, the original full length Sequence will continue playing from the point marked by the **BLUE** arrow.

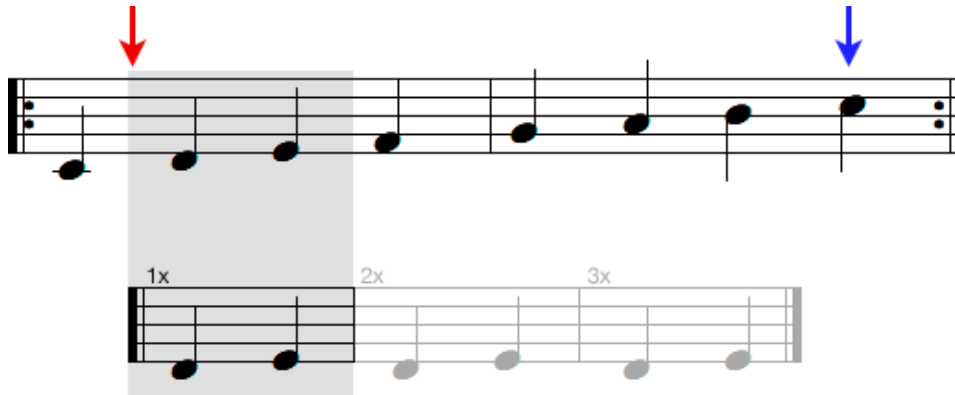

3. If, instead, you set **Loopy Pos. Sync** to *Off*, and play Loopy 4 times starting at the position indicated by the **RED** arrow (below), then when Loopy stops playing, the original full length Sequence will continue playing from the point marked by the **BLUE** arrow (below).

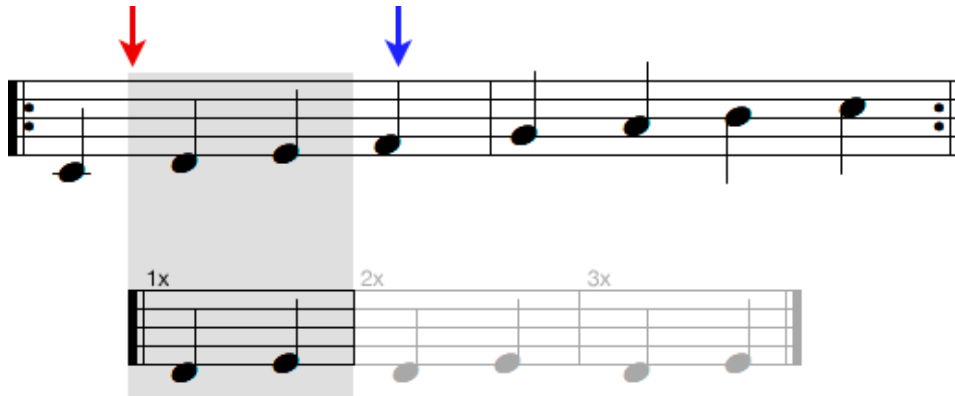

Loopy with Loops

When using the Loopy feature with Loops, Tête’s encoder bar sets Loopy’s length in “number of milliseconds.” In this way, Loopy performs like a granular sampler — enabling you to define both the length of a repeating segment and its starting point.

1. Load a loop as described in the [FILE Menu](#) discussion (or use the one you just recorded).
2. Press the **PLAY (▶)** button.



The loop starts playing.

3. Press the **LOOPY (∞)** button.



A subset of the entire recording will begin to loop. Tête displays which segment of the recording is currently being played by Loopy, including its start position, length, and current position within the active Loopy segment.

4. To change the length of the active Loopy segment, rotate Tête’s Encoder.

The Encoder Bar displays Loopy’s length (in ms). Rotating the Encoder fully counter-clockwise sets the length to **Loop Hold**, which “freezes” Tête/Tetrapad’s current output levels at the current value.

Rotating the Encoder clockwise sets increasingly longer Loopy lengths, beginning with 1ms and extending to the entire length of the recording. Loopy’s length increases (in ms) by the number of rotations squared. That is, rotating the encoder increases the length from 1ms > 4ms > 9ms > 16ms > 25ms > 36ms > etc., up to the length of your recording.

5. Press the **LOOPY (∞)** button again to exit the Loopy feature and continue playing back the entire Loop length.

Loopy exits Loopy’s subloop routine, and returns to playing back the full loop. The position at which it resumes playback is determined by the **Loopy Pos. Sync** parameter, located in the Mode SETUP Menu, and described in [Position Sync with Loops](#), below.

NOTE: Alternately, rather than toggling Loopy on/off by repeatedly pressing the **LOOPY (∞)** button, you can temporarily engage the Loopy function for as long as you hold down the button. With the **LOOPY (∞)** button held down, you can still turn Tête’s encoder to modify Loopy’s length as it plays.

Loopy Shift with Loops

Whenever you're playing back a loop, Loopy starts its sub-loop at whatever time you press the **LOOPY (∞)** button. As Loopy plays, you can shift the start of Loopy's playback either forward or backward within the recorded loop. To do so:

1. With your real-time (loop) recording playing back, press the **LOOPY (∞)** button (lighting it). Loopy begins looping a subset of the sequence, beginning at the time you pressed the **LOOPY (∞)** button, and lasting for the number of milliseconds shown on Tête's Encoder Bar.

As Loopy continues to play, press Tête's encoder to toggle encoder control to the Loopy Shift feature.



2. Turn the encoder clockwise to shift Loopy's starting step *later* in time. Turn the encoder counterclockwise to shift Loopy's starting step *earlier* in time.
3. Press the encoder to toggle back and forth between **Loopy Length** and **Loopy Shift** control — varying each in real-time as your Loopy segment plays.

NOTE: If the **LOOPY (∞)** button is currently on, you can toggle the Encoder Bar back to the standard Touch function by long-pressing (>1 sec) the Encoder.

Position Sync with Loops

After Loopy has played back a series of sub-loops, playback of the full-length loop is resumed. The precise position at which playback resumes is determined by the **Loopy Pos. Sync** parameter, located in the Mode SETUP Menu.

Specifically:

1. Press Tête's **SETUP MODE** button, and scroll down to the **Looper Sync** parameter.

If **Looper Sync** is set to *Off*, then the **Loopy Pos. Sync** parameter appears, with two choices: *Off* and *On*.

If **Looper Sync** is set to *On*, then **Loopy Pos. Sync** is automatically set to “on” (described below), and no Loopy Pos. Sync parameter exists.

2. If you want the playback to snap to the position where it would have been had you never engaged Loopy, then set **Loopy Pos. Sync** to *On* (or set **Looper Sync** to *On*).
3. If you want the playback to continue to play from the position you were in within Loopy, set **Loopy Pos. Sync** to *Off*.

The following examples illustrate the difference between these two options:

1. Assume your Loop is the length indicated by the **RED** line (below), and your Loopy segment is the length indicated by the **BLUE** line (below):



2. Assume you start playing Loopy at the position indicated by the **RED** arrow (below), and that you play the Loopy segment 4 times. If **Loopy Pos. Sync** is set to *On*, then when Loopy stops playing, the original full length loop will continue playing from the point marked by the **BLUE** arrow.



3. If, instead, you set **Loopy Pos. Sync** to *Off*, and play Loopy 4 times starting at the position indicated by the **RED** arrow (below), then when Loopy stops playing, the original full length loop will continue playing from the point marked by the **BLUE** arrow (below).



PART EIGHT:
MISCELLANEOUS

CALIBRATION

Tête and Tetrapad are both calibrated at the factory prior to shipment, so it's unlikely you'll ever need to perform any custom calibration. But if you do, these instructions (along with an external voltage meter) are all you need to calibrate either module.

Calibrating Tête

To enter Calibration Mode on your Tête:

1. Press Tête's **SETUP MODE** button to open the Mode Setup Menu.
2. Rotate Tête's encoder until the **Global Setup** option is highlighted, then press the encoder.
3. Rotate Tête's encoder until the Tête firmware version is highlighted, then press the encoder.
Tête enters System Mode.
4. Rotate Tête's encoder to highlight the **Calibration** option, then press the encoder.

The Calibration screen appears.

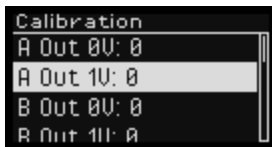

*TIP: If you make a mistake at any point during the following calibration procedure, you can scroll to the bottom of the Calibration menu and select **Reload All**. This will reload the current, previously saved values back into Tête. Once you select **Save All**, this is no longer possible, since your edited values will overwrite the previous calibration.*

To Calibrate Tête's outputs:

1. Patch **OUT A** into a calibrated voltmeter with .001V accuracy.
2. Select **A Out 0V: [number]** by pressing the encoder.
3. Rotate the encoder left or right to adjust the internal trim number until your voltmeter reads as close to 0.000V as possible, then press the encoder to lock in the offset.
4. Select **A Out 1V: [number]** by pressing the encoder.
5. Rotate the encoder left or right to adjust the internal trim number until your voltmeter reads as close to 1.000V as possible, then press the encoder to lock in the offset.
6. Repeat Steps 1-5 by patching **OUT B** into your voltmeter and duplicating the process for **B Out 0V: [number]** and **B Out 1V: [number]**.

To Calibrate Tête's inputs:

Now that OUT A and OUT B are calibrated, you can use them as reference points to calibrate the inputs.

1. Patch **OUT A** into the **X Input**.

Note: The positions of the X, Y, and Z attenuverters are ignored while calibrating.

2. Scroll to **X Trims: [number] / [number]** and auto-calibrate the input by pressing the encoder.
3. Repeat for the **Y Input**.
4. Patch **OUT A** into the **Y Input**.
5. Scroll to **Y Trims: [number] / [number]** and auto-calibrate the input by pressing the encoder.
6. Repeat for the **Z Input**.
7. Patch **OUT A** into the **Z Input**.
8. Scroll to **Z Trims: [number] / [number]** and auto-calibrate the input by pressing the encoder.
9. Scroll to **Save All**, and press the encoder to save your calibration.
10. Long-Press Tête's **SETUP** **MODE** button to get out of the Calibration Mode, and return to one of the other modes.

Calibrating Tetrapad

To enter Output Calibration Mode on your Tetrapad:

1. Power off the Tetrapad.
2. On Tetrapad's back panel, disconnect the I2C cable that connects it to Tête, and power the module back on.
3. Long-press (>1 sec) Tetrapad's white EDIT button.
4. Turn ENCODER 2 until the brightest LED beneath Tetrapad's second pad is at the top (next to the number 12).
5. Short-press (<1 sec) Tetrapad's white EDIT button.

An LED lights beneath pads 1 and 2 on Tetrapad.

6. Press the white EDIT button again.

A single red LED lights beneath one of the 8 output jacks. Tetrapad is now in its Output Voltage Calibration Mode.

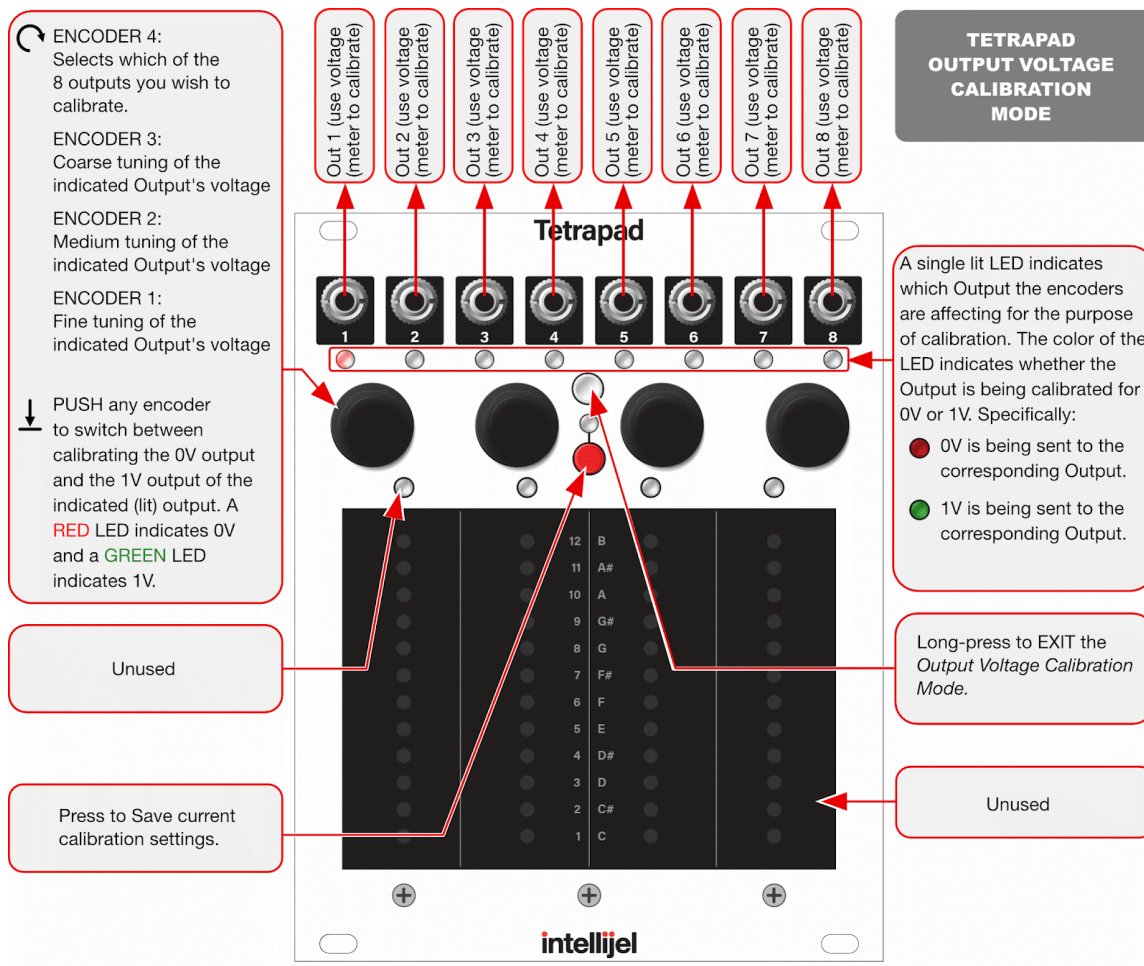

To Calibrate a Tetrapad Output:

1. Rotate the right-most encoder (Encoder 4) to select which of the 8 output voltages you wish to calibrate.

The single LED moves beneath the selected output jack to indicate which output is to be calibrated.

2. Plug a high resolution voltage meter into the Output jack whose LED is lit.

You will calibrate an output to two different voltages: 0V (as indicated by a red Output Status LED) and 1V (as indicated by a green Output Status LED).

Let's begin with the 0V calibration:

3. If the Output Status LED is currently green, push any of the four encoders to change its color to red. A red Output Status LED indicates 0V.

4. Rotate the three left encoders to set the output voltage as close to 0V as possible.
The third encoder from the left (Encoder 3) is the coarse setting. The first encoder on the left (Encoder 1) is the fine setting. Between them is Encoder 2, which provides a voltage adjustment between fine and coarse.
5. Push any of the encoders to change the Output Status LED to green, indicating that 1V is now appearing at the corresponding output.
6. Rotate the three leftmost encoders to set the output voltage as close to 1V as possible. Again, these three encoders are arranged with the finest control on the left.
7. To calibrate additional outputs, repeat steps 1-6.
8. Press the red SHIFT button to save the calibration.

To exit Output Voltage Calibration Mode:

1. Long-press the white EDIT button, and Tetrapad will exit Output Voltage Calibration Mode.
2. Power off the Tetrapad.
3. On Tetrapad's back panel, re-connect the I2C cable that connects it to Tête, and power the modules back on.

FIRMWARE UPDATES

Firmware updates, if available, are contained within the latest **Intellijel Firmware Updater** application, which you can download from the product's page on the Intellijel.com website. The application is available in both Macintosh and Windows formats, and will install firmware into your module over USB. Use the drop-down lists at the top of the application to select the product you wish to update, and the firmware version you want to install. Click the **Instructions** button to read specific instructions for updating your module.

Displaying Tetrapad Firmware Version on Tête

Tête can display its own firmware version, along with a connected Tetrapad's. To do so:

1. Short-press (<1 sec) the **SETUP MODE** button to enter the Mode Setup Menu.
2. Turn the screen encoder to highlight the **Global Setup** parameter, then push the encoder to enter the Global Setup sub-menu.
3. Turn Tête's screen encoder until you see the Tête firmware version displayed.
4. Beneath the Tête firmware version (if connected) is the Tetrapad's firmware version.

Displaying Tetrapad Firmware Version on Tetrapad

If Tetrapad is disconnected from Tête, or if its firmware is too old to be automatically detected, then the Tetrapad firmware version will not be displayed by Tête. Instead, you can use Tetrapad itself to check its firmware version:

When you first power up Tetrapad, all its LEDs blink rhythmically for a few seconds. After the light show completes and immediately before the module is ready to use, it displays (for about 1 second) the current firmware version using the Level LEDs embedded beneath each of the four pads. The display methodology used by versions 1 and 2 is different than the method used by version 3. Both are shown below:

Version 3 Firmware Display Method

For Tetrapad version 3, the four pads represent version X.Y.Y.Y as follows:

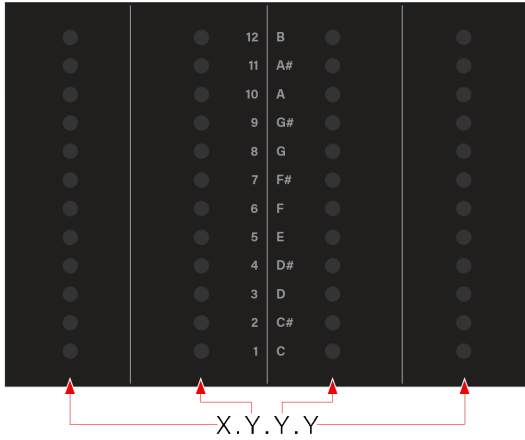

For example, version 3.1.2.0 would appear as shown below:

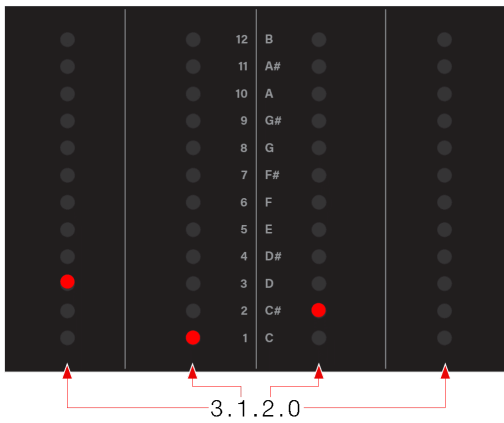

Version 1 & 2 Firmware Display Method

For Tetrapad versions 1 and 2, the four pads represent version xx.yy as follows:

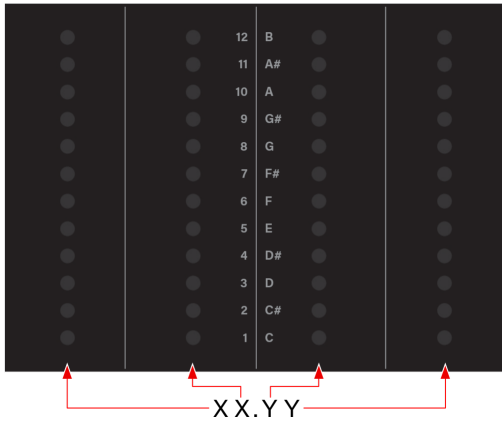

For example, version 1.10 would appear as shown on the left, and version 2.0 firmware would appear as shown on the right:

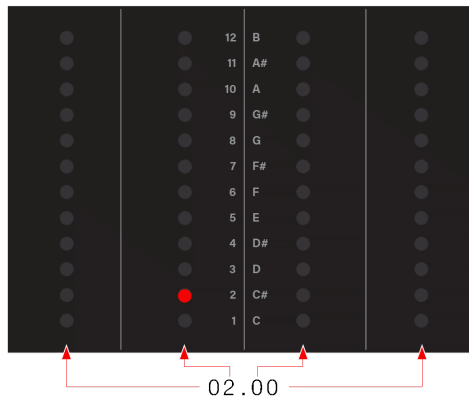
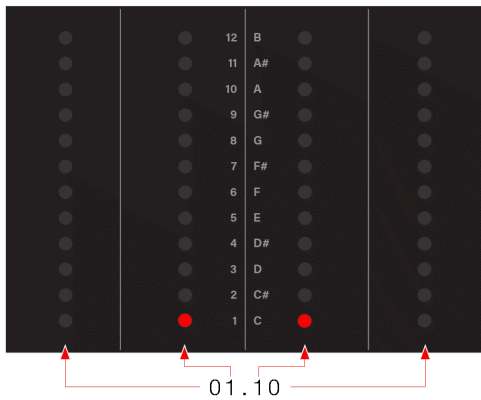

Firmware Change Log

Tête 1.1.0.1 (March 5, 2020)

- **FIXED:** The scale quantizer in Combo Mode locked to chromatic scale on pads 3 and 4.

Tête 1.1 (March 2, 2020)

IMPORTANT: You must also update your Tetrapad to version 3.0.0.1.

BASIC CHANGES:

- **NEW:** The three assignable outputs (SYNC, A, B) have a new **Run+Rec** option, which transmits a +5V gate whenever Tête is actively recording or overdubbing a loop or sequence.
- **NEW:** The three assignable outputs (SYNC, A, B) have a new **Loopy** option, which transmits a +5V gate whenever Loopy is active.
- **NEW:** The Global Setup Menu has a new **Late Comp** toggle for enabling/disabling Play/Record Compensation. It can be useful to turn this off when Tête is used as the master transport control in your system.
- **NEW:** A new **Reset Mode** option in the Mode SETUP menu enables you to reset that current mode's Mode SETUP menu options to their default, factory settings.
- **NEW:** Tête now ignores External Clock pulses that exceed 2400 BPM. Clock screen will display "Too Fast" when this rate is exceeded. This prevents Tête from becoming unstable when the operator is suffering from an excessive caffeine overdose.
- **FIXED:** Better error message if there is a problem with the SD Card.
- **FIXED:** Inconsistent or missing "Touch" CV output assignment
- **FIXED:** Negative Voltage on "Position" CV output when loop was empty
- **FIXED:** SOL/SOS CV Gate not always firing when recording a new loop
- **CHANGED:** The "Load Defaults" selection in the CV Setup menu has been renamed "Reset CV" for clarity and consistency with the new "Reset Mode" option mentioned above.

COMBO MODE CHANGES:

- **NEW:** Voltage Bank Pad - 4 pairs of stored voltages on a single pad. See [Combo Mode: Voltage Banks](#) for complete description.
- **NEW:** In Combo Mode only, the three assignable outputs (SYNC, A, B) have a new per-pad **Touch*** option (**Touch 1*** - **Touch 4***) that, if selected, transmits a +5V trigger whenever the indicated pad is touched.

- NEW: In Combo Mode only, the two assignable variable voltage outputs (A and B) have a new per-pad Pressure option (**Pressure 1 - Pressure 4**) that, if selected, transmits a control voltage based on the amount of pressure applied to the indicated pad.
- NEW: You may now independently latch the top and bottom switches on a Combo Mode switches pad. Hold down the red SHIFT button and click the encoder to toggle whether only the top or only the bottom switch is latched.

VOLTAGES MODE CHANGES:

- NEW: Set a range for randomized voltages - Two new parameters (**Random Min** and **Random Max**) in the Voltages Mode SETUP Menu work together to define the overall range of possible voltages generated whenever a voltage is randomized in Voltages Mode. Using these two parameters, you can define a randomization range as wide as 10V (-5V to +5V) or as narrow as a single volt.
- CHANGED: Holding down the red SHIFT button and pressing an encoder used to randomize the voltage on that encoder's specific output in the selected bank. It now randomizes the voltage on the encoder's specific output across ALL banks.
- CHANGED: Coarse/Fine tuning now handled with Encoder Acceleration. Turn an encoder slowly to increment in 0.01v, and turn it faster to increment more quickly. There is no more need to push-turn an encoder for fine incremental control. Note that this change requires Tetrapad 3.0.0.1 firmware or higher.

Tetrapad 3.0.0.1 (March 2, 2020)

- CHANGED: Coarse/Fine tuning now handled with Encoder Acceleration. Turn slowly to increment in slowly, and turn faster to increment more quickly. (No need to Push-Turn the encoder for fine increments)

1.0.0.4 (December 4, 2019)

- Initial Release

TECHNICAL SPECIFICATIONS

Tetrapad:

Width	20 hp
Maximum Depth	19 mm
Current Draw	130 mA @ +12V 15 mA @ -12V

Tête:

Width	8 hp
Maximum Depth	39 mm
Current Draw	120 mA @ +12V 6 mA mA @ -12V